

HUGO GENSBACH,  
Editor

# RADIO CRAFT

RADIO - ELECTRONICS

IN THIS ISSUE  
Television Power Supplies  
Handi-Dandy Transceiver



"FLYING SPOT"  
TELEVISION TUBE  
SEE TELEVISION SECTION

AUG  
1948

30

CANADA 35¢

RADIO-ELECTRONICS IN ALL ITS PHASES

# For Better Curves

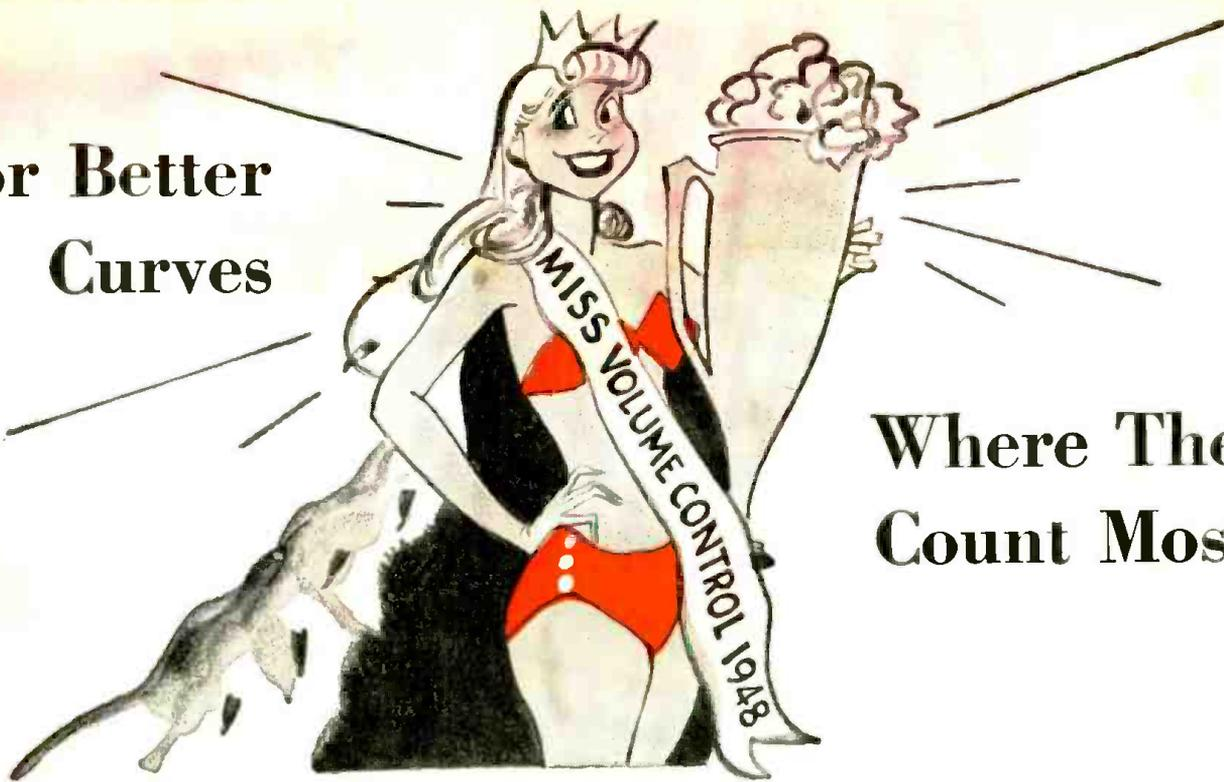

## Where They Count Most!

Accurate taper curves prove correct resistance values. When you install a Mallory carbon control, you know that your customer will get the fine, smooth tone gradations that result from tapers that are *mathematically accurate*. Mallory uses an exclusive method of applying the talcum-fine carbon so that the fields of resistance are perfectly feathered for correct attenuation.

ments—and adds manufacturing skill and repeated quality checks that assure you complete customer satisfaction when Mallory products are used.

Mallory offers the most complete line of volume controls—standardized to make them easy to stock.

Mallory makes the three replacement parts that are used on the majority of your jobs: volume controls, capacitors and vibrators. Into them, Mallory builds design experience that has been acquired by constantly keeping a step ahead of commercial radio-electronic develop-



Mallory controls are carefully tested for taper accuracy. The exclusive method of applying carbon gives a more gradual taper curve than is produced by competitive controls.

### The Mallory 1485 Control Deal

This attractive metal cabinet contains the 15 Controls and 9 Switches that will take care of 90% of your service calls. Its arrangement makes inventory control almost automatic—saves you frequent trips to the distributor's counter. It contains a rack for your Radio Service Encyclopedia. You pay only for the Volume Controls and Switches; the cabinet is included in the deal at no extra cost to you. Check your Mallory distributor on this special offer.



P. R. MALLORY & CO. Inc.  
**MALLORY**

CAPACITORS . . . CONTROLS . . . VIBRATORS . . .  
SWITCHES . . . RESISTORS . . . RECTIFIERS . . .  
VIBRAPACK\* POWER SUPPLIES . . . FILTERS

\*Reg'd U. S. Pat. Off.

**APPROVED PRECISION PRODUCTS**

P. R. MALLORY & CO., Inc., INDIANAPOLIS 6, INDIANA

# I WILL SEND YOU BOTH FREE

## 64 PAGE BOOK

See how I give you practical experience building Radio circuits at home with **BIG KITS OF PARTS I SEND**. Illustrated books shows how you make extra money fixing Radios in spare time while still learning. Read letters from men I trained, telling what they are doing, earning. See the kind of fascinating jobs Radio, Television, Electronics offer. **FREE** with coupon below!

## ACTUAL RADIO LESSON

Same coupon entitles you to **FREE** "superhet" circuits work, three real lesson, "Getting Acquainted With Receiver Servicing." Discloses short-cuts Radio Repairmen use. Tells how

sons why tubes fail, locating defects, repairing loudspeaker. Over 80 pictures, diagrams. **FREE!** Send coupon!

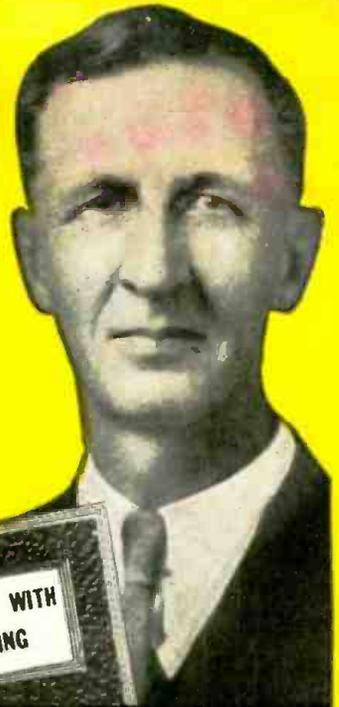
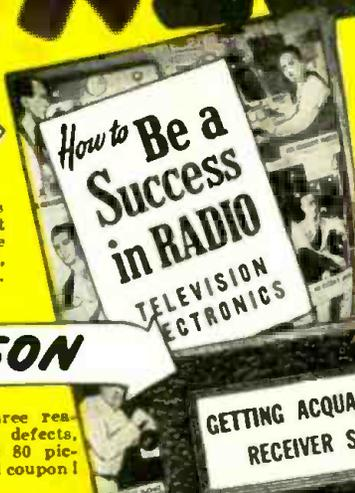

# See for yourself how I train you at home to BE A RADIO TECHNICIAN

Do you want a good-pay job in the fast-growing **RADIO and Television-Electronics Industries?** Or do you want to be boss of your own money-making Radio shop? Here is your chance!

I've trained hundreds of men to be Radio Technicians . . . men with no previous experience. I can do the same for you! My unique train-at-home method makes learning easy. I send you **BIG KITS** of Radio parts. All equipment yours to keep. You get practical Radio experience building, testing and experimenting with Radio circuits.

### Make EXTRA Money In Spare Time

The day you enroll, I start sending you **EXTRA MONEY** booklets. You **LEARN** Radio and Television principles from my easy-to-grasp, step-by-step illustrated lessons. You **PRACTICE** with parts I send. You **USE** your know-how to make extra money fixing neighbors' Radios in spare time. From here, it's a short step to your own shop or a good pay Radio job.

### N.R.I.—Trained Men Face Bright Future

Think of the money-making opportunities in Police, Aviation, Marine Radio, Broadcasting, Radio Manufacturing, Radio Repairs, Public Address work, etc. And think of even greater opportunities as Television, FM and Electronic devices become more and more available.

### See What N.R.I. Can Do For You

Act now! Send for my **DOUBLE FREE OFFER**. Coupon entitles you to actual lesson, "GETTING ACQUAINTED WITH RECEIVER SERVICING," absolutely free. Discloses short-cuts of Radio repair men. Over 80 pictures and diagrams! Also get my 64-page book, "HOW TO BE A SUCCESS IN RADIO - TELEVISION - ELECTRONICS." Tells more about **YOUR** opportunities, details of my Course. Read letters from men I trained, telling what they are doing and earning. . . . see how quickly, easily you can get started. Send coupon in envelope or paste on penny postal. **J. E. SMITH, Pres., Dept. 5MX, National Radio Institute, Pioneer Home Study Radio School, Washington, D. C.**

**VETERANS GET THIS TRAINING UNDER G. I. BILL**

### I TRAINED THESE MEN



"Now have two Radio shops, servicing about 200 sets a month. Highly successful our first full year." — **ARLEY STUDYVIN, DeSoto, Missouri.**



"Earned enough spare time cash to pay for my Course by time I graduated. N. R. I. training is tops!" — **ALEXANDER KISH, Carteret, New Jersey.**

My Course Includes Training in **TELEVISION ELECTRONICS — FM**

### You Build This MODERN RADIO with Parts I Send

Complete, powerful Radio receiver brings in local and distant stations. N. R. I. gives you **ALL** the Radio parts . . . speaker, tubes, chassis, transformer, sockets, loop antenna, etc.



**MAIL NOW**

**I Also Send You Many Other RADIO KITS**

### Actual Lesson and 64 Page Book FREE

**MR. J. E. SMITH, President, Dept. 5MX National Radio Institute, Washington 9, D. C.**

Mail me **FREE** Sample Lesson and 64-page book about how to win success in Radio and Television—Electronics. (No salesman will call. Please write plainly.)

Name..... Age.....  
Address.....  
City..... Zone..... State.....

Check If Veteran  
**APPROVED FOR TRAINING UNDER G. I. BILL**

Capitol Radio Engineering Institute—Pioneer in Radio Engineering Instruction Since 1927



## How Much Competition Have You

... For Your Present Job—For a Better Job?

Enjoy Security and Good Pay! Step Ahead of Competition into a BETTER RADIO JOB with CREI Technical Home Study Training. Protect your future today—keep ahead of the man who is waiting for your job—plan for the better job that can be yours.

Once again, employers can afford to be "selective", particularly when so many ambitious, young men have entered the radio industry since the war. This means you must improve your technical ability not only to meet the industry's new developments, but to meet the job competition you are now facing.

You may have "gotten by" up to this point. But, if you are like many other radiomen, many of the recent technical advances have passed you by. Radio-electronics developments of the past few years call for an entirely new understanding and knowledge of technical radio practice.

If you have had professional or amateur radio experience and want to make more money, let us prove to you we have the training you need to qualify for a better radio job. To help us answer intelligently your inquiry—please state briefly your background of experience, education and present position.



## Capitol Radio Engineering Institute

An Accredited Technical Institute

Dept. RC-8, 16th and Park Road, N. W., Washington 10, D. C.  
Branch Offices. New York (7) 170 Broadway • San Francisco (2) 760 Market St.

We invite you to see, without obligation, just what CREI home study training can do for you. Beginning *right now* CREI can provide *on-the-job-training* that is practical and thorough. You will find it helpful in your daily work right from the very first lesson. You can "go all the way with CREI" from introductory basic principles (for the man with limited experience) to advanced training and specialized subjects (for the man with greater experience). No matter what your experience, CREI has a course for you.

The facts about CREI and what we can do for you are described interestingly in our 24-page booklet. It is well worth reading. Send for it today.

VETERANS! CREI TRAINING AVAILABLE UNDER G. I. BILL

### MAIL COUPON FOR FREE BOOKLET

#### CAPITOL RADIO ENGINEERING INSTITUTE

16th and Park Road, N. W., Dept. RC-8, Washington 10, D. C.

Gentlemen: Please send your free booklet, "CREI training for your better job in Radio-Electronics," together with full details of your home-study training. I am attaching a brief resume of my experience, education and present position.

Check field of greatest interest:

- PRACTICAL RADIO-ELECTRONICS       PRACTICAL TELEVISION  
 BROADCASTING       AERONAUTICAL RADIO ENGINEERING  
 RECEIVER SERVICING       INDUSTRIAL ELECTRONICS

NAME \_\_\_\_\_

STREET \_\_\_\_\_

CITY \_\_\_\_\_

ZONE \_\_\_\_\_

STATE \_\_\_\_\_

I AM ENTITLED TO TRAINING UNDER G. I. BILL.



# Learn RADIO

## TELEVISION, ELECTRONICS

### SHOP METHOD HOME TRAINING

Let NATIONAL SCHOOLS, of Los Angeles, a practical Technical Resident Trade School for almost 50 years, train you for today's unlimited opportunities in Radio

You receive all parts, including tubes, for building this fine, modern Superheterodyne Receiver. This and other valuable standard equipment included now properly.

*these two FREE books will tell you how*



### Good Jobs Await the Trained Radio Technician

You are needed in the great, modern Radio, Television and Electronics industry! Trained Radio technicians are in constant and growing demand at excellent pay—in Broadcasting, Communications, Television, Radar, Research Laboratories, Home Radio Service, etc. National Schools Master Shop Method Home Study course, with newly added lessons and equipment, can train you in your spare time, right in your own home, for these exciting opportunities. Our method has been proved by the remarkable success of National Schools-trained men all over the world.

### You Learn by Building Equipment with Standard Radio Parts We Send You

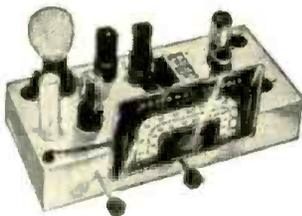

Your National Schools Course includes not only basic theory, but practical training as well—you learn by doing. We send you complete standard equipment of professional quality for building various experimental and test units. You advance step by step until you are able to build the modern superheterodyne receiver shown above, which is yours to keep and enjoy. You perform more than 100 experiments—build many types of circuits, signal generator, low power radio transmitter, audio oscillator, and other units. The Free Books shown above tell you more about it—send for them today!

### Now! NEW PROFESSIONAL MULTITESTER INCLUDED!



This versatile testing instrument is portable and complete with test leads and batteries. Simple to operate, accurate and dependable. You will be able to quickly locate trouble and adjust the most delicate circuits. You can use the Multitester at home or on service calls. It is designed to measure AC and DC volts, current, resistance and decibels. You will be proud to own and use this valuable professional instrument.

Lessons and Instruction Material Are Up-to-date, Practical, Interesting.

Here's Just a Few of the Interesting Facts you Learn with the

#### FREE MANUAL

1. Routine for diagnosing Radio Troubles.
2. Preliminary Inspection of Receivers.
3. How to Test and Measure Voltages.
4. How to Test Speaker in Audio Stages.
5. How to Trace the Circuit and Prepare Skeleton Diagram.
6. Complete Reference Table for Quickly Locating Receiver Troubles.

Both Home Study and Resident Training Offered

**APPROVED FOR VETERANS**

Check Coupon Below

## NATIONAL SCHOOLS

LOS ANGELES 37, CALIFORNIA EST. 1905



### MAIL OPPORTUNITY COUPON FOR QUICK ACTION

National Schools, Dept. RC-8,  
4000 S. Figueroa, Los Angeles 37, Calif.

Print on a postcard

Mail me FREE the books mentioned in your ad including a sample lesson of your course. I understand no salesman will call on me.

NAME ..... AGE .....

ADDRESS .....

CITY ..... ZONE ..... STATE .....

Check here if Veteran of World War II

GET THE DETAILS—SEND THE COUPON

# ALLIED has Everything New in Radio!



**NEW hallicrafters  
SX-62 RECEIVER**  
Designed for Short Wave  
Listeners and DX Fans

## Television by hallicrafters



### 505 TELEVISION TABLE MODEL

The immensely popular direct-viewing Hallicrafters TV receiver in a distinctively styled wood table model cabinet. Here's perfected, clear, sharp, bright Television at amazingly low cost. Provides a brilliant picture 5 3/4" long by 4" high—a full 23 sq. inch picture area. Easy to operate: push-button station selection, simplified contrast control, easy horizontal and vertical framing. Has built-in 6" x 4" oval PM speaker; excellent sound. Overall size: 20 1/2" long, 11" high, 17" deep. For 105-125 volts, 50-60 cycles AC. Complete with tubes. Shpg. wt., 45 lbs. **\$179.50**  
97-803. NET, f.o.b. Chicago .....  
Terms: \$35.90 down, \$12.68 monthly for 12 months.  
*Famous Model T-54.* Same as above, but in furniture steel cabinet, finished in rich silver-gray.  
97-800. NET, f.o.b. Chicago ..... **\$169.50**  
Terms: \$33.90 down, \$11.98 monthly for 12 months.

Developed and built especially for the SWL. Total tuning range is 540 kc to 110 mc, continuously, covering world-wide Short-Wave and special services, broadcast, and all FM channels between 27 mc and 110 mc. Features: professional slide-rule dial with foreign Short-Wave stations and all services (marine, aviation, etc.) located on the dial; 500 kc crystal calibrator; pointer adjustment to set receiver on exact frequency; single knob tuning, 60 to 1 tuning ratio; each band separately illuminated; series type ANL; 4-position tone control; high-fidelity audio system; 8 watts output; dual IF channels; six-step selectivity; crystal filter; record-player input—plus a host of other desirable features. In handsome steel cabinet, 20" x 10 1/4" x 16". For 105-125 volts, 50-60 cycle AC. Complete with tubes. Shpg. wt., 65 lbs.  
97-585. SX-62. NET, f.o.b. Chicago ..... **\$249.50**  
Terms: \$49.90 down, \$17.63 monthly for 12 months.  
97-780. R-42 Speaker. Bass-reflex type, in matching metal cabinet. Shpg. wt., 20 lbs. NET ..... **\$34.50**  
97-568. B-42 Tilt-Base. Chrome finished. Shpg. wt., 6 lbs. NET ..... **\$7.50**

## There's Only ONE COMPLETE Radio Buying Guide—It's ALLIED'S CATALOG!

Get the Radio Buying Guide that's used by thousands of expert servicemen, engineers, soundmen, Amateurs, builders and experimenters! Radio's biggest catalog brings you the widest selections of the newest and finest equipment, at money-saving low prices. Get every buying advantage at ALLIED—speedy, expert shipment, the personal attention of seasoned radio experts—complete satisfaction on every order. Get your ALLIED Catalog today!



**172 VALUE-PACKED  
PAGES. SEND FOR IT!**

**FREE**

**THE WORLD'S  
LARGEST  
RADIO  
SUPPLY  
HOUSE . . .**

**★ ALLIED  
RADIO**  
*Everything in Radio  
and Electronics*

ALLIED RADIO CORP.  
833 W. Jackson Blvd., Dept. 2-H-8  
Chicago 7, Illinois

- Send FREE 172-Page ALLIED Catalog.
- Enter order for Hallicrafters Model.....
- Enclosed \$.....  Full Payment
- Port Payment (Balance C.O.D.)
- Send ALLIED Easy Payment Plan details and order blank.

Name.....  
Address.....  
City..... Zone..... State.....

I Put You to Work with Your Hands to LEARN RADIO!  
You Build Receivers! You Make Typical Defects Occur  
and Make Tests to Prove the Theory!



F. L. SPRAYBERRY, PRES-  
IDENT of the SPRAYBERRY  
ACADEMY OF RADIO. This  
is the man who directs  
your study. His years of  
experience and Radio  
"know-how" assure you of  
the finest in home Radio  
Training!

**YOU GET**  
**8 BIG KITS OF RADIO**  
**PARTS & EQUIPMENT**  
including  
**2-BAND SUPER**  
**RECEIVER!**  
and **16 RANGE METER**  
**FOR TESTING**

**LEARN RADIO**  
**to MAKE MONEY!**

**LOW COST TRAINING — EASY PAYMENT PLAN!**

You Learn at Home How to  
Build and Test Dozens and  
Dozens of Circuits — Simple  
and Complex!

**YOU DO**  
**OVER 175**  
**INSTRUCTIVE**  
**EXPERIMENTS**

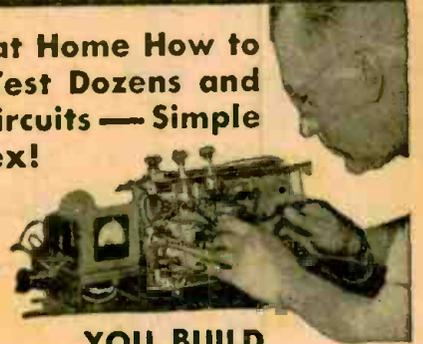

**YOU BUILD**  
**ALL THESE TESTERS**  
**..... AND MORE!**

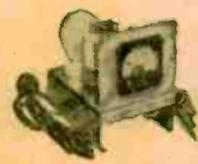

I give you a fine,  
moving-coil type  
Meter Instrument  
on Jewel Bearings  
— with parts for a  
complete Analyzer  
Circuit Continuity  
Tester. You learn  
how to check and  
correct Receiver  
defects with professional speed and  
accuracy.

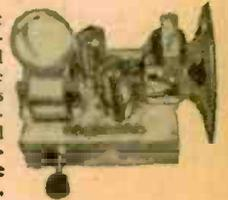

You'll get  
valuable ex-  
perience and  
practice  
building this  
Signal Gen-  
erator and  
multi-  
purpose  
Tester. Makes a  
breeze out of fixing Radios and you  
don't have to spend money on ready-  
made Equipment.

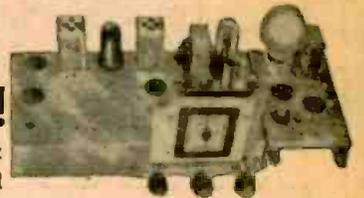

Soldering, wiring, connecting Radio  
parts . . . building circuits with your  
own hands — you can't beat this  
method of learning. When you con-  
struct this Rectifier and Filter, Res-  
istor and Condenser Tester, etc., you  
get a really practical slant on Radio  
that leads to a money-making future.

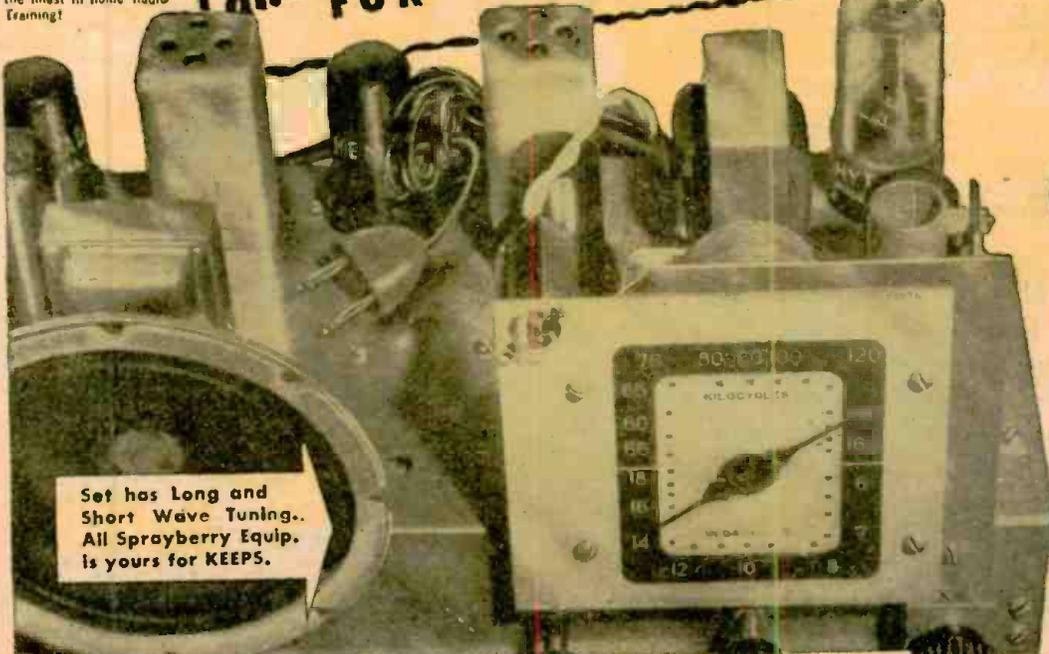

Set has Long and  
Short Wave Tuning..  
All Sprayberry Equip.  
is yours for **KEEPS**.

**SPRAYBERRY HOME TRAINING is PLANNED to MAKE MONEY for you FAST!**

I train you with regular professional Radio Equip-  
ment. I tell you exactly what to do . . . how to do  
it. You handle Radio Parts, see them operate,  
learn what they're for. With the fine Kits I supply,  
you learn how to build Radio Circuits, construct  
your own Test Equipment. I'll show you how to  
cause typical Radio defects so you can watch and  
see how they act. You learn the latest methods for  
trouble-shooting and repair. All this adds up to

the finest kind of "bench" experience. And you get  
it right in your own home. In no time at all, you'll  
be ready for a business of your own or a good job  
in Radio, FM, Television,  
Radar, Industrial Elec-  
tronics, etc. Now's  
the time to get  
started!



**SEND FOR MY**  
**VALUABLE**  
**FREE BOOKS!**

**"How To Read Radio Diagrams and Symbols"**

A wonderfully complete new book, which explains in  
simple English how to read and understand any Radio  
Set Diagram. Includes translation of all Radio sym-  
bols. Send for this volume at once! It's free! With  
it I'll send you another Big Free Book, describing in  
detail my Radio Electronic Training!

**SPRAYBERRY ACADEMY OF RADIO**

F. L. Sprayberry, President  
Room 2088, Sprayberry Building, Pueblo, Colorado

Please rush my FREE copies of "How to MAKE MONEY in RADIO, ELEC-  
TRONICS and TELEVISION" and "HOW to READ RADIO DIAGRAMS and  
SYMBOLS."

Check here if a veteran.

Name ..... Age .....

Address .....

City ..... State .....

(Mail in envelope or paste on penny postcard)

**VETERANS!**  
Approved for  
G.I. Training  
Under Public  
Laws 16 and 346.  
Mail Coupon  
for Full  
Details.

# Build YOUR OWN TEST EQUIPMENT

## \$39.50

*Nothing  
ELSE TO BUY*

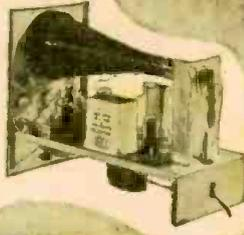
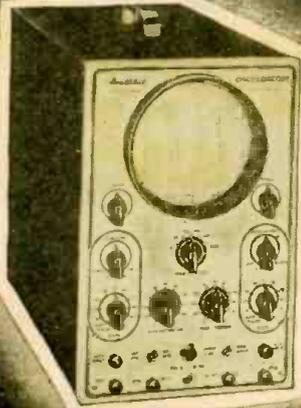

## NEW 1948 HEATHKIT 5" OSCILLOSCOPE KIT

A necessity for the newer servicing technique in FM and television at a price you can afford. The Heathkit is complete, beautiful two color panel, all metal parts punched, formed and plated and every part supplied. A pleasant evening's work and you have the most interesting piece of laboratory equipment available.

Check the features — large 5" 5B1 tube, compensated vertical and horizontal amplifiers using 6SJ7's, 15 cycle to 30 M cycle sweep generator using 884 gas triode, 110V 60 cycle power transformer gives 1100 volts negative and 350 volts positive.

Convenient size 8 1/2" x 13" high, 17" deep, weight only 26 pounds.

All controls on front panel with test voltage and ext. syn post. Complete with all tubes and detailed instructions. Shipping weight 35 pounds.

Order today while surplus tubes make the price possible.

## HEATHKIT SINE AND SQUARE WAVE AUDIO GENERATOR KIT

The ideal companion instrument to the Heathkit Oscilloscope. An Audio Generator with less than 1% distortion, high calibration accuracy, covering 20 to 20,000 cycles. Circuit is highly stable resistance capacity tuned circuit. Five tubes are used, a 6SJ7 and 6K6 in the oscillator circuit, a 6SL7 square wave clipper, a 6SN7 as a cathode follower output and 5Y3 as transformer power supply rectifier.

The square wave is of excellent shape between 100 and 5,000 cycles giving adequate range for all audio, FM and television amplifier testing.

Either sine or square waves available instantly at a toggle switch. Approximately 25V of sine AC available at 50,000 ohm output impedance. Output +1 db. from 20 to 20,000 cycles. Nothing else to buy. All metal parts are punched, formed and cadmium plated. Complete with tubes, all parts, detailed blueprints and instructions.

## HEATHKIT SIGNAL TRACER KIT

Reduces service time and greatly increases profits of any service shop. Uses crystal diode to follow signal from antenna to speaker. Locates faults immediately. Internal amplifier available for speaker testing and internal speaker available for amplifier testing. Connection for VTVM on panel allows visual tracing and gain measurements. Also tests phonograph pickups, microphones, PA systems, etc. Frequency range to 200 Mc. Complete ready to assemble. 110V 60 cycle transformer operated. Supplied with 3 tubes, diode probe, 2 color panel, all other parts. Easy to assemble, detailed blueprints and instructions.

Small portable 9" x 6" x 4 3/4". Wt. 6 pounds. Ideal for taking on service calls. Complete your service shop with this instrument.

## HEATHKIT SIGNAL GENERATOR KIT

Every shop needs a good signal generator. The Heathkit fulfills every servicing need, fundamentals from 150 Kc. to 30 megacycles with strong harmonics over 100 megacycles covering the new television and FM bands. 110V 60 cycle transformer operated power supply.

400 cycle audio available for 30% modulation or audio testing. Uses 6SN7 as RF oscillator and audio amplifier. Complete kit has every part necessary and detailed blueprints and instructions enable the builder to assemble it in a few hours. Large easy to read calibration. Convenient size 9" x 6" x 4 3/4". Weight 4 1/2 pounds.

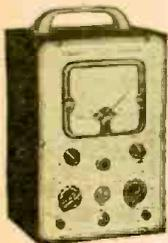

## \$24.50

*Nothing  
ELSE TO BUY*

## THE NEW HEATHKIT VACUUM TUBE VOLTMETER KIT

The most essential tool a radio man can have, now within the reach of his pocketbook. The Heathkit VTVM is equal in quality to instruments selling for \$75.00 or more. Features 500 microamp meter, transformer power supply, 1% glass enclosed divider resistors, ceramic selector switches, 11 megohms input resistance, linear AC and DC scale, electronic AC reading RMS. Circuit uses 6SN7 in balanced bridge circuit, a 6H6 as AC rectifier and 6X5 as transformer power supply rectifier. Included is means of calibrating without standards. Average assembly time less than four pleasant hours and you have the most useful test instrument you will ever own. Ranges 0.3, 30, 100, 300, 1000 volts AC and DC. Ohmmeter has ranges of scale times 1, 100, 1000, 10M and 1 megohm, giving range .1 ohm to 1000 megohms. Weight 8 lbs.

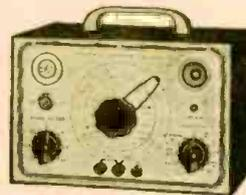

## \$19.50

## HEATHKIT CONDENSER CHECKER KIT

A condenser checker anyone can afford to own. Measures capacity and leakage from .0001 to 100 MFD on calibrated scales with test voltage up to 500 volts. No need for tables or multipliers. Reads resistance 500 ohms to 2 megohms. 110V 60 cycle transformer operated complete with rectifier and magic eye indicator tubes.

Easy quick assembly with clear detailed blueprints and instructions. Small convenient size 9" x 6" x 4 3/4". Weight 4 pounds. This is one of the handiest instruments in any service shop.

## \$34.50

Shipping Wt., 13 lbs.



## \$19.50

*Nothing  
ELSE TO BUY*



## \$19.50

*Nothing  
ELSE TO BUY*



# The HEATH COMPANY

DEPT. C . . . BENTON HARBOR, MICHIGAN



# COMMAND SET ACCESSORIES

# BEST OF KITS

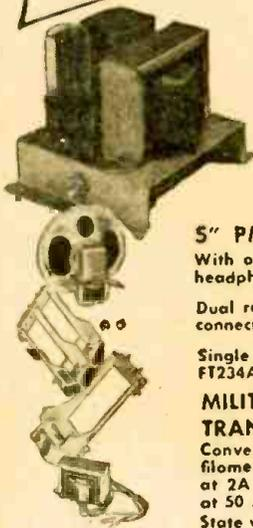

## 110 V. A.C. MILITARY RECEIVER POWER SUPPLY KIT

Ideal way to convert military sets. Supplies 24 Volts for filament—no wiring changes inside radio. Also supplies 250 V. D.C. plate voltage at 50-60 MA. Connections direct to dynamotor input. Complete with all parts and detailed instructions. Ship. Wt., 6 lbs. **\$ 5.95**

### 5" PM SPEAKER

With output transformer, matching headphone output **\$2.80**

Dual receiver rack FT277A with connecting plugs **\$1.00**

Single transmitter rack FT234A **\$1.00**

### MILITARY CONVERSION POWER TRANSFORMERS

Convert your military receivers without rewiring the filament. "A" type supplies 500 VCT at 50 MA, 5V at 2A and 24V at 1/2A. "B" type supplies 500 VCT at 50 MA, 5V at 2A and 12V at 1 amp. State whether A or B type desired. **\$2.95**

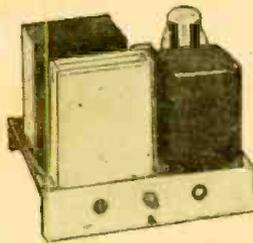

## 110 V. A.C. TRANSMITTER POWER SUPPLY KIT

For BC-645, 223, 522, 274N's, etc. Ideal for powering military transmitters. Supplies 500 to 600 Volts at 150 to 200 MA plate, 6.3 C.T. at 4 Amps, 6.3 at 4 Amps and 12V at 4 Amps. Can be combined to supply 3-6.9-12 or 24 Volts at 4 Amperes! Kit supplied complete with husky 110V 60 cycle power transformer, 5U4 rectifier, oil filled condensers, cased choke, punched chassis, and all other parts, including detailed instructions. Complete—nothing else to buy.

**\$14.50**

TRANSFORMER ONLY **\$9.50**

## POWER TRANSFORMER *Specials*

A wonderful buy in a new production heavy duty power transformer. Primary 117 V 60 cycle. Secondaries supply 746 V.C.T at 220 MA, 6.3 V. at 4.5 A., and 5 V. at 4 A. An ideal transformer for high quality amplifier modulator, small transmitter or quality radio. Will handle 13 tube radio receivers. Supply is limited, order early. Shipping Weight, 11 lbs. each.

**\$3.95 . . . 3 for \$9.95**

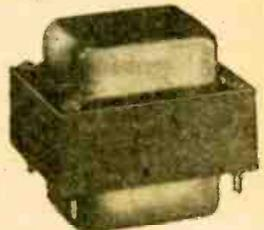

### INPUT AND OUTPUT TRANSFORMER

Two units in one case carbon microphone input and output from 155 to 150 ohm load used in Handle Talkie No. 744 special 4 for **\$1.00**



OUTPUT TRANSFORMER Push pull 6V6's to 6-8 ohm voice coil excellent characteristics No. 800. 3 for **\$1.95**

Filter Choke 15 henries at 60 MA cased type hermetically sealed No. 643, each **\$1.00**



OUTPUT TRANSFORMER Couples, 6C4, 6J5, etc. to 500 or 5,000 ohm line No. 716. 2 for **\$1.00**

## MIDGET AMATEUR TRANSMITTER KIT

Complete kit to assemble a 1 Watt battery operated amateur 80 meter transmitter, including tube and crystal. Range up to 500 miles. Only accessories needed are sending key and batteries. Complete instructions supplied. Add postage for 2 lbs.

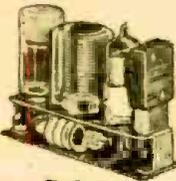

**\$3.95**

### ACCESSORIES

Key (add postage for 2 lbs.) **\$1.00**  
Kit of batteries (add postage for 4 lbs.) **3.25**

## HEATHKIT HIGH FIDELITY AMPLIFIER KIT

Build this high fidelity amplifier and save two-thirds of the cost. Push pull output using 1619 tubes (military type 616's), two amplifier stages using a dual triode (6SN7), and a phase inverter give this amplifier a linear reproduction equal to amplifiers selling for ten times this price. Every part supplied; punched and formed chassis, transformers (including quality output to 3-8 ohm voice coil), tubes, controls, and complete instructions. Add postage for 20 lbs. 12" PM speakers for above. **\$6.95**

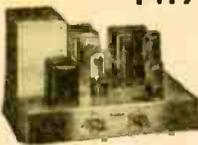

**\$14.95**



## T32 TABLE MICROPHONE

One of the Army's best. Built by Kellogg, ideal for factory call system, public address, amateur use. Brand new in original cartons, add postage for 5 lbs. **\$2.95**

## DYNAMOTORS

Consists of electric motor operating generator on same shaft. Many applications—operating radios from storage battery—using as motor.



Dynamotor C—Input 28 volts, output 220 volts at 60 MA. Shipping Weight 6 pounds. **\$1.50**

Dynamotor A—Input 12 volts, output 1000 volts at 350 MA. Shipping Weight 72 pounds. **\$5.95**

Dynamotor B—Input 6 or 12 volts, output 500 volts, 160 MA. Shipping Weight 30 pounds. **\$5.95**



## METER *Special*

Brand new DeJur Model 312 0-800 M.A. D.C. Square 3" 0-10 M.A. basic meter with built in shunt. Probably the best buy ever offered in a surplus meter. Shipping weight 1 lb. **\$2.95**

## LOOK AT THE PARTS IN A GENERAL ELECTRIC BC-375 TUNING UNIT



FOR *Only* **\$2.49**

A beautiful aluminum case ideal for building a receiver or transmitter. Three variable condensers, transmitting coils, transmitting mica condensers, ceramic switches, National Velvet Vernier dial, ceramic insulated couplings, 10 banana jacks, RF chokes, etc. The parts in this unit will be useful for years.

This is truly the greatest buy in surplus—better order one while still available. We include plans for converting to an 80 meter transmitter receiver all for \$2.49. Specify TU26B (200-500 KC.) or TU10B. (10 to 12.5 MCs) Shipping weight 20 lbs.

## HEATHKIT 3-TUBE ALL-WAVE RADIO

110-volt AC operation **\$8.75**

## HEATHKIT 3-TUBE ALL-WAVE RADIO

An ideal way to learn radio. This kit is complete ready to assemble, with tubes and all other parts. Operates from AC. Simple, clear detailed instructions make this a good radio training course. Covers regular broadcasts and short wave bands. Plug-in coils. Regenerative circuit. Operates loud speaker. Battery model for use where no AC house current is available. Add postage for 3 lbs.



HS 30 Headphones per set **\$1.00**  
2 1/2" permanent magnet loudspeaker **\$1.95**

## INTERPHONE 2-WAY CALL SYSTEM KIT

Ideal call and communication system for homes, offices, factories, stores, etc. Makes excellent electronic baby watcher, easy to assemble with every part supplied including simple instructions. Distance up to 1/5 mile. Operates from 110 V.A.C. 3 tubes, one master and one remote speaker. Shipping Weight 5 pounds. **\$14.50**

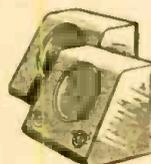

**\$14.50**

**The HEATH COMPANY**  
DEPT. C . . . BENTON HARBOR, MICHIGAN

# 12 BOOKS IN 1

## IN THE RADIO DATA BOOK

The only Radio Handbook of its kind! . . . 1148 pages, 12 sections, each a complete coverage of one radio subject.

Together, the 12 sections form the most complete Radio Handbook you can BUY! Easy to read . . . A quick reference!

Plan every operation in radio and electronics with the Radio Data Book. This new radio bible will be your lifelong tool . . . you will use it every day, on the board, at the bench, in the field! Use it for engineering, construction, trouble-shooting and testing. The RADIO DATA BOOK will be your invaluable aid in design, experiment and in layout. It will help make your production better, faster and easier. In any and every operation in radio and electronics, you will use the RADIO DATA BOOK!

The RADIO DATA BOOK is a work of complete authority, prepared by engineers with many years of practical experience. They have been assisted by the Boland & Boyce staff of editors skilled in preparing electronics manuals for the U. S. Signal Corps for many years. These men have worked for several years gathering material for this book . . . all the knowledge of radio principles and operation . . . all the statistics . . . all the newest developments in electronics . . . every possible angle and detail. Eighteen months were spent digesting this material into the most concise, the clearest, and the most readable form. The result is this invaluable manual . . . The RADIO DATA BOOK. Whether you use this book for general reference, for scientific instruction, or for education, one thing is certain—the practical help, the daily usefulness you will derive from it will prove to be worth many, many times its astonishingly low price!

Here's a description of just ONE section—Section 5, Sound Systems:

This section covers the planning, selection of components, and assembly of complete P.A. installations. Every type of unit and material used in a sound system is described and analyzed. Components are classed as to size and type of P.A. installations in which they should be used. Tables and charts are given from which to determine power and ratings. Microphone and speaker construction are described and illustrated in detail . . . placement in auditoriums, etc., for proper acoustical results is explained and illustrated. Patterns of the different types of microphones are illustrated as are the proper methods of wiring up the various units, etc.

The above is just one of the twelve big sections in the RADIO DATA BOOK. We wish we had room here to describe all twelve in detail, but just look over the list of sections, and you will see why this is the best radio handbook money can buy. Send in your order for the RADIO DATA BOOK today.

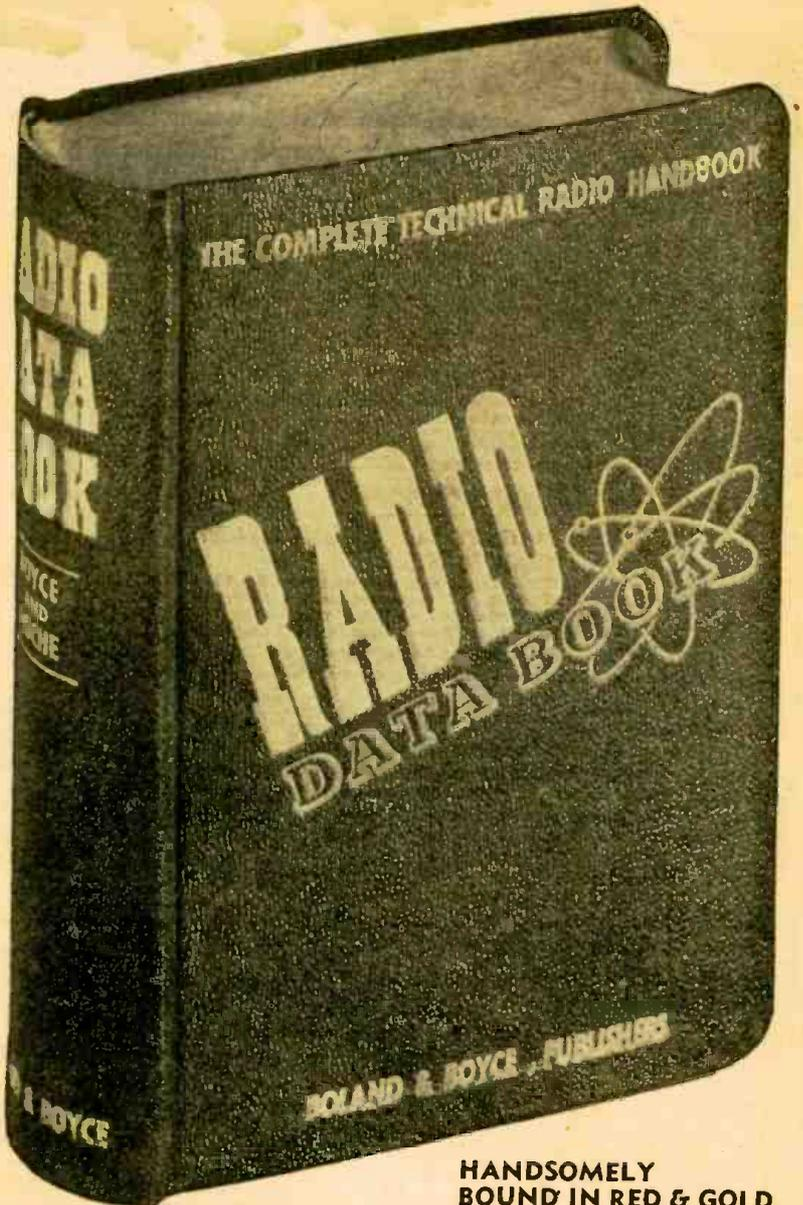

**HANDSOMELY BOUND IN RED & GOLD**

12 sections . . . 1148 pages . . . Completely Illustrated

- SECTION 1. THE 150 BASIC CIRCUITS IN RADIO.
- SECTION 2. COMPLETE TEST EQUIPMENT DATA.
- SECTION 3. TESTING, MEASURING AND ALIGNMENT.
- SECTION 4. ALL ABOUT ANTENNAS.
- SECTION 5. SOUND SYSTEMS.
- SECTION 6. RECORDING.
- SECTION 7. COMPLETE TUBE MANUAL.
- SECTION 8. CHARTS, GRAPHS AND CURVES.
- SECTION 9. CODES, SYMBOLS AND STANDARDS.
- SECTION 10. 50 TESTED CIRCUITS DESIGNED FOR OPTIMUM PERFORMANCE.
- SECTION 11. DICTIONARY OF RADIO AND ELECTRONIC TERMS.
- SECTION 12. RADIO BOOK BIBLIOGRAPHY.

**12 complete books in one only \$5.00**  
Less than 42c per book!

**Coming Soon!**

## The VIDEO HANDBOOK

Everything in Television in one Complete Text-book. Over 500 pages completely illustrated.

This new handbook will be invaluable to everyone concerned with the technical aspect of Television. Everything from the basic theory of television through the design and characteristics of receivers to final installation, operation, and maintenance is covered. This is a completely new book that includes all of the latest developments in the field—the components discussed are of the newest design—the practical maintenance described is a result of intensive study of the equipment placed in operation during the past few months.

There are five completely illustrated sections in the VIDEO HANDBOOK, each over a hundred pages long. Each section completely covered.

The VIDEO HANDBOOK will be out in December, but we have received a flood of orders already. To insure your getting a copy in the first printing—mail your order now.

The VIDEO HANDBOOK is \$5.00 alone, or you can order it with the RADIO DATA BOOK and get both books at the special price of \$9.00. Send in the coupon today!

Mail this coupon to your jobber—or direct to: RC-8

**BOLAND & BOYCE, INC., PUBLISHERS**  
460 Bloomfield Ave., Montclair, N. J.

Please send me:

The Radio Data Book at \$5.00. (Foreign \$5.50)

The Video Handbook at \$5.00. (Foreign \$5.50)

Both Books at the Special price of \$9.00. (Foreign \$10.00)

I enclose full payment.

I enclose \$1.00 and will pay balance to postman on delivery. (In U. S. only)

NAME .....

ADDRESS .....

CITY .....

STATE .....

ZONE .....

**BOLAND & BOYCE INC., PUBLISHERS**

# BIG NEWS from DeForest's Training, Inc.

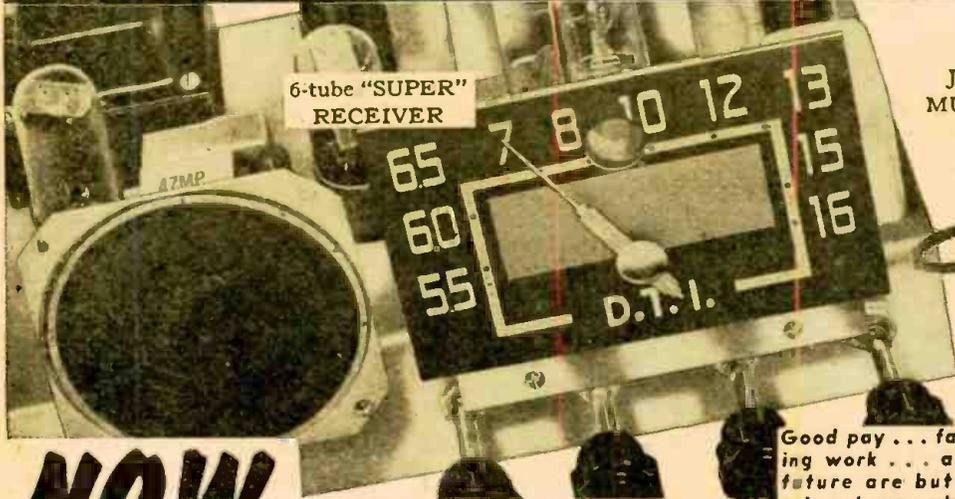

6-tube "SUPER" RECEIVER



Jewel Bearing MULTI-METER

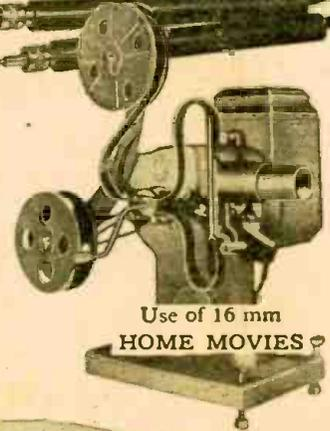

Use of 16 mm HOME MOVIES

## NOW you can get and KEEP all of this equipment to help you master... RADIO - TELEVISION ELECTRONICS at Home!

You LEARN-BY-DOING from building:

- (1) A modern 6-tube Superhet Receiver with MAGIC TUNING EYE, plus phono switch, tone control, and other features.
- (2) A high grade, commercial-type MULTI-METER with jewel bearing movements.
- (3) Over 200 instructive experiments from many shipments of Radio-Electronic parts, including tools.

You mount your parts on individual bases with spring clip terminals, enabling you to build new circuits and to experiment in a fraction of time normally required.

**PLUS...** the use of Learn-By-Seeing MOVIES. Only D.T.I. provides this remarkable training advantage in your own home to help you learn FASTER... EASIER!

**PLUS...** D.T.I.'s effective EMPLOYMENT SERVICE to aid you in getting started in Radio-Electronics-Television.

Mail the coupon today for FREE FACTS on how DeForest's Training, Inc., sends you everything you need to prepare and get started in America's great opportunity fields.

IF YOU PREFER, you can get your training in modern, well-equipped Chicago laboratories. Write for details.

## DeFOREST'S TRAINING, INC.

Chicago, Illinois

Associated with the DeVry Corporation, Builders of Electronic and Movie Equipment

Good pay... fascinating work... a bright future are but a few advantages ahead of trained men in the opportunity fields of RADIO-TELEVISION-ELECTRONICS. Write for late facts about Television, F.M., Radio, Broadcasting, 2-Way Mobile Radio, Train Radio, and other fast-moving branches. See how D.T.I. helps you get started.



ABOVE: In addition to the Radio-Electronic equipment you keep, you get the use of a 16 mm. Movie Projector and many reels of film to speed your progress.

Many shipments of Radio-Electronic parts, permitting over 200 fascinating experiments

### MAIL THIS OPPORTUNITY COUPON NOW!

DeForest's Training, Inc.  
2533 N. Ashland Ave., Dept. RC-E8  
Chicago 14, Illinois

Send me complete details showing how I may make my start in Radio-Electronics-Television. No obligation.

Name \_\_\_\_\_ Age \_\_\_\_\_

Address \_\_\_\_\_ Apt. \_\_\_\_\_

City \_\_\_\_\_ Zone \_\_\_\_\_ State \_\_\_\_\_

If under 16, check here for special information.  If a discharged veteran of World War II, check here.

**AUGUST • 1948**

**Editorial**

The Future of Radio and Television.....by R. C. Cosgrove, Guest Editor 17

**Electronics (pages 20-22)**

The Crystal Detector—Part II.....by Jordan McQuay 20

**Radio-Science (page 23)**

Image Magnifier Amplifies Light..... 23

**Television (pages 24-25)**

Television Power Supplies.....by E. J. Bukstein 24  
"Flying Spot" C-R Tube (Cover Feature)..... 25

**Test Instruments (pages 26-29)**

Radio-Frequency V.T.V.M.....by A. A. Goldberg 26  
Audio Oscillator Has Single Control.....by Richard D. Henry 28  
Impedance Measuring Methods.....by Rufus P. Turner 29

**Audio (pages 30-38)**

Electron Music with the Fototone.....by Lyman E. Greenlee 30  
Simple Tracer-Amplifier.....by Homer L. Davidson 32  
Checking Performance of Phono Pickups.....by Richard H. Dorf 33  
Church Bell Records..... 35  
The Hi-Fi Expert Tracks Down Hum.....by James R. Langham 36  
Hearing Aid Has Pickup Coil..... 38

**Amateur (pages 39-42)**

A Folded Dipole 10-Meter Antenna.....by A. B. Kaufman 39  
Surplus Conversions.....by Milton Kalashian 40  
Handi-Dandy Transceiver.....by William E. Pike, W1KMW 41  
An S-Meter for Your Receiver.....by H. Hatfield 42

**Servicing (page 44)**

Converting Farm Sets for A.C.....by Alfred Shortcut 44

**Construction (pages 49-56)**

Compact Radio from Holland..... 49  
A Six-Tube Dry-Cell Superhet.....by Edwin Bohr 51  
Neon Lamp Experiments.....by Harold Pallatz 52  
Direction Indicator.....by W. H. Gibson 56

**Theory and Design (page 57)**

Regulated Supply..... 57

**Foreign News (pages 67-69)**

Report from Britain.....by Major Ralph W. Hallows 67  
Radio in Latin America.....by E. A. Conklin 69

**FM (pages 70-72)**

A.F.C. Stops Drift.....by L. S. Wecker 70  
Multi-Element FM Tube..... 71

**Departments**

The Radio Month..... 18  
New Devices..... 43  
Try This One..... 58  
Radio-Electronic Circuits..... 60  
Question Box..... 64  
New Patents..... 73  
Technotes..... 76  
World-Wide Station List.....by Elmer R. Fuller 78  
Radio Business..... 79  
Miscellany..... 80  
Communications..... 82  
Book Reviews..... 84



RADIO-ELECTRONICS

Incorporating

SHORT WAVE CRAFT\* TELEVISION NEWS\*

RADIO & TELEVISION

\*Trademark registered U. S. Patent Office

**HUGO GERNSBACK**

*Editor-in-Chief*

FRED SHUNAMAN, *Managing Editor*

M. HARVEY GERNSBACK, *Consulting Editor*

ROBERT F. SCOTT, W2PWG, *Technical Editor*

ANGIE PASCALE, *Production Manager*

I. QUEEN, W2OUX, *Editorial Associate*

ELMER FULLER, *Shortwave Editor*

G. ALIQUO, *Circulation Manager*

JOHN J. LAMSON, *Advertising Director*

ALFRED STERN, *Promotion Manager*

**In an Early Issue**

TELEVISION RECEIVER ALIGNMENT  
ELECTRONIC MEDICAL RESEARCH  
UNIVERSAL TEST INSTRUMENT

**On the Cover:**



RCA's "flying-spot" television light source. The person in the photograph is L. E. Swedlund, who developed the new equipment.

Chromatone by Alex Schomburg from RCA photo by Gordon W. Hemmerly.

ABC PAID CIRCULATION 6 MONTHS TO DEC. 31, 1947—102,688. (Publishers Statement)

PRINTED FOR AUGUST ISSUE—149,000



RADCRAFT PUBLICATIONS, INC. Hugo Gernsback, President; M. Harvey Gernsback, Vice President; G. Aliquo, Secretary

Contents Copyright, 1948, by Radcraft Publications, Inc. Text and illustrations must not be reproduced without permission of Copyright owners.

RADCRAFT PUBLICATIONS INC. • PUBLICATION OFFICE 29 Worthington Street, Springfield 3, Mass. Address all correspondence to N. Y. office. EDITORIAL AND ADVERTISING OFFICES 25 West Broadway, New York 7, N. Y. Telephone REctor 2-9690. BRANCH ADVERTISING OFFICES: Chicago: 308 W. Washington Street, Chicago 6, Ill. Tel. Randolph 7363. Detroit: Frank Holstein, Manager, Room 402 Lexington Bldg., 2970 West Grand Blvd., Detroit 2, Mich. Telephone Madison 7026-7. Los Angeles: Ralph W. Harker, Manager, 606 South Hill St., Los Angeles 14, Calif. Tel. Tucker 1793. San Francisco: Ralph W. Harker, Manager, 582 Market St., San Francisco 4, Calif. Tel. Garfield 1-2481.

RADIO-CRAFT, August, 1948, Volume XIX, No. 11. Published monthly on 25th of month preceding date of issue. Allow one month for change of address. When ordering a change, please furnish an address stencil impression from a recent wrapper. All communications about subscriptions should be addressed to the Circulation Manager, Radio-Craft, 29 Worthington St., Springfield 3, Mass., or 25 West Broadway, New York 7, N. Y.

SUBSCRIPTION RATES: United States and possessions, Mexico, Central and South American countries, \$3.50 a year; \$6.00 for two years; \$8.00 for three years. Canada, \$4.00 a year; \$7.00 for two years; \$9.50 for three years. All other foreign countries, \$4.25 a year, \$7.50 for two years; \$10.25 for three years.

FOREIGN AGENTS: Great Britain: Atlas Publishing and Distributing Co., Ltd., 18 Bride Lane, Fleet St., London E.C.4. Australia: McGill's Agency, 179 Elizabeth Street, Melbourne. France: Brentano's, 37 Avenue de l'Opera, Paris 2e. Holland: Trilectron, Heemsteedsche, Dreef 124 Heemstede. Greece: International Book & News Agency, 17 Amerikis Street, Athens. So. Africa: Central News Agency, Ltd., Cor. Rissik & Commissioner Sts. Johannesburg; 112 Long Street, Capetown; 369 Smith Street, Durban. Natal. Universal Book Agency, 70 Harrison Street, Johannesburg. Middle East: Steimatzy Middle East Agency, Jaffa Road, Jerusalem. India: Susil Gupta (Distributors) Co., Amrita Bazar Patrika Lt., 14 Ananda Chatterjee Lane, Calcutta.

# Which Do You Want?



Better Pay



A Nice Home

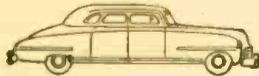

A New Car



Greater Security



Happy Vacations and Travel

Jobs worth \$3000 to \$7500 are opening up right now for FCC Licensed Radiomen

# How to Pass FCC Commercial Radio Operator LICENSE EXAMS

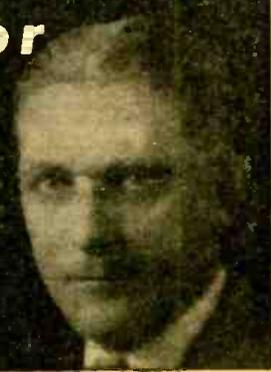

## GET YOUR FCC TICKET IN A FEW SHORT WEEKS

Get your license easily and quickly and be ready for the \$3000 to \$7500 jobs that are open to ticket holders. CIRE training is the only planned course of coaching and training that leads directly to an FCC license.

### IT'S EASY WITH CIRE COACHING AND TRAINING

Your FCC ticket is recognized in all radio fields as proof of your technical ability. Employers often give preference to license holders, even though a license is not required for the job. Hold an FCC "ticket" and the job is yours!

### Look what these students say:

"Thanks to this course, I now have a very good job in a local power plant's test department. I couldn't have obtained this job without the math and basic electrical theories in the first part of Section I of this course." Stud. No. 2893N12

"I have been working for Police Radio Station WPFS in Asheville for five months since getting my second-class ticket." Stud. No. 2858N12

"You may be interested to know that I am employed at the local broadcast station, where I am a transmitter operator. I took and passed the FCC examinations last February." Stud. No. 2754N12

**CLEVELAND INSTITUTE OF RADIO ELECTRONICS**  
RC-8 Terminal Tower Cleveland 13, Ohio

Approved for Training under "G. I. Bill of Rights"



I can train you to pass your FCC License Exams in a few short weeks if you've had any practical radio experience—amateur, Army, Navy, radio servicing or other. My time-proven training plan can help put you, too, on the road to success—**Let me send you FREE the entire story** Just fill out the coupon and mail it. I will send you, free of charge, a copy of "How to Pass FCC License Exams," plus a sample FCC-type Exam and Catalog A, describing opportunities for you in Radio-Electronics.

EDW. H. GUILFORD, Vice-President.

## Get All 3 FREE Send Coupon Now!

**CLEVELAND INSTITUTE OF RADIO ELECTRONICS**  
RC-8 Terminal Tower, Cleveland 13, Ohio

I want to know how I can get my FCC ticket in a few short weeks. Send me your FREE booklet, "How to Pass FCC License Examinations" (does not cover exams for Amateur License), as well as a sample FCC-type exam and Catalog A, describing opportunities in Radio-Electronics.

NAME .....

ADDRESS .....

CITY ..... ZONE ..... STATE .....

Veterans check for enrollment information under G.I. Bill.

**NO OBLIGATION—NO SALESMEN.**

# SLASHED PRICES DOWN

No. D-4064

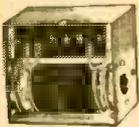

## DYNAMOTOR

Used with the popular BC-312 Radio Receiver, 12 volts input—235 volts @ 90 ma. Output complete with filter mounted in can.

**\$2.49**

No. H-466

## THREADWELL TAP AND DIE KIT

Here is a complete Radio Man's tool kit. All popular sizes of taps & dies for Radio Use. Mounted in a metal tool kit.

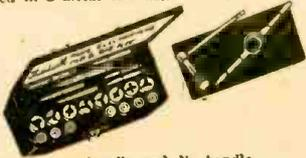

Includes the tap handle and die handle. No radio man can afford to be without this kit. List price \$16.00. Your cost.... **\$12.00**

## HS-16 HEADSET

- 8000 ohms HI-Impedance
- Noise proof
- Most sensitive phone bell
- May be used as a sound powered intercom.



Light, durable, efficient. Molded neoprene earcups shaped to completely envelop entire ear. Adjustable headband extends or retracts. Especially suited to hams, commercial operators, aircraft pilots, recording engineers and many others. Can be used with simple Xtal to make complete radio receiver. Original cost \$25.00.....Special **\$1.89**  
6 foot extension cord.....49c

## CARBON THROAT MICROPHONE

This microphone will work into any 200 ohm impedance input circuit. Has adjustable strap to fit any neck. Ideal for ultra high frequency mobile work for hams. Supplied with strap, 10' cord and plug. Can also be used as a hi-grade Carbon Mike by simply drilling three holes in case. Your cost..... **49c**

## COMBINATION OFFER BOTH ITEMS

Include 25c to cover cost of postage **\$2.25**

## DESIGNED FOR THE 522

### TRANSMITTER

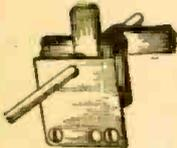

A Four Band Selector Unit which replaces the selector motor allowing you to change frequency from the front panel quickly. Can be installed in 10 minutes.

**\$3.00 each**

No. C-641

## R.F. UNITS FROM THE BC-312

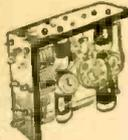

Contain six coils which cover from 1500 KC to 18 Mc. Has a ceramic band switch to change from any coil. Each coil is tuned with an air padder. Build your own receiver or signal generator with this assembly. A marvelous **\$1.98**  
Buy at.....

No. H-400

## WATERPROOF METAL BOX

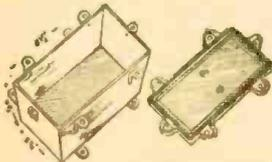

Easily opened. Completely sealed against moisture when closed. Large enough to use for tuning units outside at beam at any place where waterproofing is necessary. 4 1/2" high. 5 1/4" wide. 8 1/4" long..... **\$2.00**

# KITS!

## TUBE KITS

Complete Set of Tubes for SCR-522.....	<b>\$17.95</b>
Complete Set of Tubes for BC-348.....	<b>\$7.95</b>
Complete Set of Tubes for BC-312.....	<b>\$7.95</b>

Specify Model Numbers

## BC-348 Owners

### CONVERTER for BROADCAST BAND

Convert that BC-348 without any alteration in your circuit. Our special converter takes power from receiver. Just tune your set to 450 kc. and forget it. All tuning is done on a converted panel covering 550 to 1600 kc.—double conversion means High Sensitivity. Excellent Fidelity and Higher Selectivity—complete basic kit with schematic and full instructions—less chassis dial and tuning knobs. **\$6.50**  
Terrific Buy at.....

## Do You Own an SCR-522

We have a complete power supply containing all the necessary parts down to the line cord, pilot light switch & terminal blocks & delivers the following voltage—300 v. DC @ 250 mills. 150 v. of regulated bias and sufficient 12 v. to operate the tubes of both receiver and transmitter. Complete at the amazingly low **\$14.95**  
price of.....

## Model 200-EA 5-ELEMENT 2 METER BEAM KIT

Folded di-pole driven element. All-aluminum construction. Feed with low impedance coaxial cable. Amateur net price..... **\$8.40**

**HOTTEST ITEM OUT!!** Make your SCR-522 Receiver operate on 144 to 148 Mc. with ONE DIAL control, in less than 1 hour! Parts and instructions..... **\$3.00**

No. 3-651

## DI HEPTAL SCOPE SOCKET



Socket 14 pin for the new 10HP4 complete with leads. Designed for high voltage. A very popular item. .... **\$1.49**

No. K-600

## Speed Keys Made by Ted McElroy

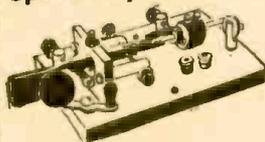

The World's Champion CW man—beautifully made with large contacts. Designed for any keying application.

No. K 600A All plated including base..... **\$9.66**

No. S-4704

## MOSSMAN SWITCHES

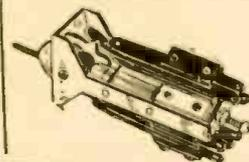

Always Popular in Two Models.

1 Triple Pole Double Trow..... **\$1.25**

2 Ten Pole Double Trow..... **\$2.10**

No. N-268

## VIBRATOR POWER SUPPLY



Made by Mallory. 12 volts input. Delivers 190 volts @ 85 ma. Perfect for mobile receivers. Load drain battery current. Made to rigid Army specifications. **\$3.50**

No. S-4614

## HEAVY 8" P.M. SPEAKER



Will handle Power—7 oz. Alnico 5 Magnet. A wonderful buy. This speaker is designed with a Ripple Edged cone for faithfully reproducing the low frequencies..... **\$3.89**  
Only two to a customer.



## VIBRATORS in stock

Type A Standard 6 Prong Base Synchronous 6 volt. Type B. Same as above but designed for 110 v.

Either Type **\$1.09**

No. S-601

## SPERTI Vacuum Switch

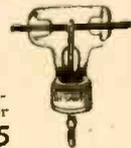

Used in the famous Collins Art-13 Transmitter for Antenna Switching..... **\$1.95**

No. B-4011

## 2 VOLT STORAGE BATTERY

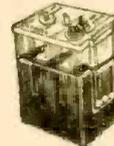

Wonderful for mobile equipment. A rugged plastic case will allow you to use this battery without worrying about breakage—30 amp capacity balls on side tells when battery needs recharg. **\$3.49**  
Ing. Size 5"x3"x4"

No. T-606

## 400 CYC. OSC. COIL PERMEABILITY TUNED



Here is your chance to add modulation to either your BC-221 Frequency Meter or to any other piece of equipment you are contemplating..... **\$2.49**

## SENSATIONAL CRYSTAL MIKE VALUE



Never before offered at this low price! High quality crystal hand-mike, unidirectional. Wide range response. Massive one-piece construction. 2 1/2" diam. by 1 1/2" thick. Complete with attached 100-ft. shielded mike cable. A truly wonderful buy, for only..... **\$5.95**

No. T-4640

## TRANSFORMER

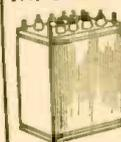

Here is a rugged transformer built to Army specs. Hermetically sealed with Franklin terminals for easy soldering. Primary 115 v. 60 eyes.  
Sec. No. 1 850 v. ct @ 58 ma.  
Sec. No. 2 5.4 v. @ 3 a.  
Sec. No. 3 6.4 v. @ 6 a.

Weight 10 lbs. Your cost..... **\$2.49**

No. T-6042

## POWER TRANSFORMER

Heavy Duty 750 volts C.T. @ 250 ma. with a 130 volt bias tap—perfect for oscilloscope supply or any application needing these voltages. Size 5 1/2" high 5 1/2" wide 5" deep. Weight 21 lbs. **\$5.45**

20% DEPOSIT WITH ORDERS UNLESS RATED

# NIAGARA RADIO SUPPLY CORP.

160 GREENWICH STREET

NEW YORK 6, N. Y.

ALL PRICES F. O. B. N. Y. C.

# LARGEST STOCK OF TUBES IN THE COUNTRY

ALL BRAND NEW — STANDARD BRANDS — QUANTITY PRICES ON REQUEST — Minimum Order \$5.00

1B24	4.95	9MP7	14.95	806	17.50	C58	12.95	1C6	1.06	6AQ7GT	.88	6Y6G	.88	14H7	.88
1B25A	4.95	10BP4	34.95	807	1.25	C6A	9.95	1C7G	1.06	6AR5	.66	6Z7G	1.28	14J7	1.06
1B26	15.95	10CP4A	42.20	808	2.95	C6J	12.95	1C8	.88	6AT6	.54	6ZY5G	.72	14N7	1.06
1B27	4.95	10FP4	54.50	809	2.50	CEQ72	1.95	1D5G	1.28	6AU6	.72	7A4/XXL	.72	14Q7	.88
1B29	4.95	10MP4	49.50	810	7.95	CK1005	.39	1D5GP	1.28	6AV6	.54	7A5	.72	14R7	.88
1B32	4.95	10Y	.69	811	2.25	CK1006	.69	1D7G	1.06	6B4G	1.06	7A6	.72	14S7	1.06
1B56	8.00	10 spec.	.69	812	2.95	EF50	.79	1D8GT	1.28	6B5	1.56	7A7	.72	14W7	1.06
1N21	.59	12DP7	14.95	812H	6.90	EL3C	4.95	1E5GT	1.56	6B6G	.72	7A8	.72	14X7	1.06
1N23	.59	12GP7	14.95	813	7.95	EL225	1.95	1E7GT	1.56	6B7	1.06	7AD7	1.06	14X4	.88
1P22	11.50	12JP4	60.00	814	4.95	F123A	12.95	1F4	.88	6B8	1.06	7AF7	.72	19	1.06
1P24	2.00	15AP4	125.00	815	2.50	F127A	22.50	1F5G	.88	6B8G	1.06	7AG7	.88	19T8	1.06
1S21	1.95	15E	1.50	816	1.19	F660	150.00	1F6	1.28	6BA6	.66	7AH7	.88	20	1.56
2AP1	2.95	15R	1.50	822	11.95	FG81A	6.95	1F7G	1.28	6BE6	.66	7B4	.72	22	1.28
2B22	5.35	20AP4	270.00	826	.79	FG105	19.95	1G4GT	.88	6BG6G	1.92	7B5	.72	24A	.72
2C21	.98	23D4	.49	827R	99.50	FG172A	32.50	1G6GT	.88	6BH6	.93	7B6	.72	25A6	1.06
2C22	.39	45 spec.	.49	828	6.95	FG238B	160.00	1H4G	.72	6BJ6	.72	7B7	.72	25AG6	1.06
2C26A	.75	75TL	3.95	829/A/B	7.95	GL146	11.00	1H5GT	.60	6C4	.60	7B8	.72	25AC5GT	1.06
2C34	.59	100TH	12.95	829B/3E29	4.95	GL605	250.00	1H6G	1.06	6C5	.60	7C4/1203A	1.06	25C6G	1.06
2C40	1.98	100TS	3.00	830B	5.25	GL697	150.00	1H6GT	1.06	6C5GT	.72	7C5	.72	25L6GT	.60
2C43	7.50	102F	4.00	832/A	3.95	HF100	3.95	1J6GT	1.06	6C6	.72	7C6	.72	25Y5	1.06
2C44	1.75	114A	.69	833A	39.50	HF200	17.95	1L4	.72	6C8G	1.06	7C7	.72	25Z5	.54
2C46	7.50	114B	1.25	836	1.15	HY24	1.50	1LA4	1.06	6D6	.60	7E5/1201	1.06	25Z6	.72
2D21	1.69	120	5.95	837	2.50	HY31Z	5.50	1LA6	1.06	6D8G	1.06	7E6	.72	25Z6GT	.54
2D29	1.39	121A	2.65	838	3.95	HY69	2.49	1LB4	1.06	6E5	.72	7E7	.88	26	.60
2E22	1.50	203B	10.95	841	.69	HY75	1.25	1LC5	1.06	6F5	.60	7F7	.88	27	.54
2E24	4.37	203R	5.95	843	.69	HY1148	1.25	1LC6	1.06	6F5GT	.60	7F8	1.06	28D7	.98
2E25	3.95	204A	49.95	845	4.95	HY115	1.25	1LD5	1.06	6F6	.72	7G7/1232	1.06	30	.72
2E26	3.29	205B	4.50	845W	5.95	HY615	1.25	1LE3	1.06	6F6GT	.60	7A7	.80	31	.72
2E30	2.25	211	.98	851	98.00	HYE1148	.48	1LG5	1.06	6F7	.60	7J7	1.06	32	.72
2J21A	14.95	215A	3.00	852	14.95	HY1231Z	5.50	1LH4	1.06	6F8G	1.06	7K7	1.06	32L7GT	1.28
2J22	24.95	217C	7.50	860	3.00	HY1269	5.50	1LN5	1.06	6G6G	.88	7L7	.88	33	1.06
2J26	14.95	221A	2.95	861	49.95	KC4	105.00	1N5GT	.72	6H6	.60	7N7	.88	34	1.06
2J31	24.95	222A	120.00	864	.69	KU676	22.00	1P5GT	.88	6H6GT	.60	7Q7	.72	35/51	.72
2J32	24.95	227A	3.95	865	.98	ML100	105.00	1Q4GT	.88	6J5	.54	7R7	1.06	35A5	.72
2J34	24.95	241B	90.00	866A	1.95	ML101	150.00	1R5	.72	6J5GT	.54	7V7	1.06	35B5	.72
2J38	37.50	242C	5.95	868	1.95	ML502	300.00	1S4	.88	6J6	1.06	7W7	1.06	35L6GT	.60
2J39	34.95	249C	3.49	869B	75.00	MR4	90.00	1S5	.66	6J7	.72	7X7/XXFM	1.06	35W4	.46
2J40	34.95	250R	7.95	872A	2.50	KQ59	45.00	1T4	.72	6J7G	.72	7Y4	.72	35Y4	.72
2J42	34.95	250TH	19.50	874	2.49	QK60	45.00	1T5GT	.88	6J7GT	.72	7Z4	.72	35Z3	.72
2J49	34.95	250TL	19.50	876	.98	QK61	55.00	1U4	.72	6J8G	1.06	10	1.56	35Z4GT	.50
2J51	34.95	252A	4.95	878	2.49	QK62	55.00	1U5	.66	6K5GT	.88	12A6	.89	35Z5GT	.46
2J551	4.95	259A	4.95	879	.89	REL21	4.25	1V5	.72	6K6GT	.54	12A6GT	1.06	35Z6G	.88
2J53	25.00	274A	1.25	884	.98	RK12	1.95	1V	.72	6K7	.60	12A7	1.06	36	.88
2J54	25.00	274B	1.25	889	.98	RK21	3.95	1V5	.88	6K7G	.60	12A8GT	.72	37	.60
2K25	24.95	301A	4.95	891	110.00	RK22	4.95	1W5	.88	6K7GT	.60	12A9GT	.88	38	.72
2K28	24.95	304TH	7.95	892R	200.00	RK25	2.95	2A3	1.06	6K8	.88	12AH7GT	.88	39/44	.59
3AP1	2.95	304TL	1.98	902P1	7.95	RK33	.98	2A4G	1.28	6K8G	1.06	12AL5	.72	41	.60
3B22	4.95	305A	12.95	905	11.95	RK34	.59	2A5	.72	6K8GT	.88	12AT6	.54	41	.60
3B23	4.95	307A	6.25	920	2.95	RK59	3.95	2A6	.88	6L5G	.88	12AT7	1.06	42	.60
3B24	1.95	310	4.95	923	.98	RK60	.79	2A7	2.20	6L6	1.28	12AU6	.72	43	.60
3B25	.98	311A	1.98	931A	4.95	RK65	24.95	2B7	.88	6L6G	1.06	12AU7	.88	45	.60
3B26	5.95	316A	.89	950	1.06	RK69	49.50	2E5	.88	6L6GA	1.06	12AW6	.96	45Z5GT	.60
3BP1	2.95	322A	120.00	953B	4.95	RK72	1.95	2V3G	1.10	6L7	.88	12BA6	.66	46	.88
3C21	5.95	327A	4.95	954	.75	RK73	3.95	2X2A	.69	6L7G	.88	12BE6	.66	47	.88
3C22	2.95	331A	4.95	955	.75	RK75	6.25	3A4	.72	6L8	1.06	12C8	.89	49	.88
3C23	4.95	350/A/B	2.95	956	.75	RX120	10.00	3A5	1.29	6N6G	1.28	12FGT	.60	50	1.56
3C24	.69	353A	4.95	957	.75	T20	1.95	3A8GT	1.92	6N7	.88	12H6	.60	50A5	.88
3C30	1.50	368AS	9.95	958A	.75	T240	2.95	3B7	1.06	6N7GT	.88	12J5GT	.54	50B5	.72
3CP1	3.00	371A	2.95	959	.75	UX6653	3.95	3C6/XXB	1.28	6P5GT	.88	12J7G	.72	50C6G	1.06
3BP1	3.95	371B	2.95	991	.69	V700	6.95	3D6	.88	6Q6G/6T7G	1.06	12J7GT	.72	50L6GT	.60
3EP1	3.95	388A	7.95	1000 spec.	24.95	VR75	.98	3E6	1.06	6Q7	.72	12K7G	.72	50X6	.88
3D21A	3.00	393A	7.95	1000T	75.00	VR78	.75	3FL4	1.06	6Q7GT	.60	12K8GT	.88	50Y6GT	.60
3E29	4.95	394A	4.50	1611	.99	VR90	.75	3Q4	.72	6R7	.88	12K8GT	.88	51	.88
3GP1	4.95	417A	24.95	1613	.75	VR91	1.49	3Q5GT	.88	6R7GT	.88	12K9GT	.88	52	.60
4-65A	14.50	434A	3.95	1614	1.75	VR92	.75	3S4	.72	6S7	.88	12SA7	.60	57	.72
4-125A	27.50	446A	1.95	1616	1.39	VR105	.75	3V4	.72	6S7G	.88	12SA7GT	.60	58	.72
4-250A	37.50	450TH	24.95	1619	.75	VR150	.98	5A24	.42	6S8GT	.88	12SC7	.72	59	1.06
4A1	1.98	503	195.00	1621	1.98	VT127A	3.00	5474	1.03	6S8GT	.96	12SF5	.60	70L7GT	1.42
4AP10	6.95	527	12.95	1622	1.75	VU111	1.19	5T4	1.28	6S8A7	.60	12SFT5	.72	71A	.72
4B24	4.95	531	49.50	1624	1.75	WL460	14.95	5U4G	.53	6SB7Y	.88	12SF7	.72	75	.60
4C35	19.95	575A	14.95	1625	.49	WL468	14.95	5V4G	.88	6SC7	.72	12SF7GT	.88	76	.60
4E27	8.95	632A	9.95	1626	.49	WL532A	4.95	5W4	.88	6SD7GT	.96	12SH7	.72	77	.60
4J28	34.95	701A	4.95	1627	7.95	WL562	150.00	5W4GT	.60	6SF5	.60	12SH7GT	.72	78	.60
4J29	34.95	702A	3.95	1629	.69	WL616	105.00	5X4G	.60	6SG7	.72	12SHT	.60	79	.88
5AP1	4.95	703A	4.95	1630	7.50	WL619	49.50	5Y3G	.50	6SH7	.72	12SJ7	.60	80	.42
5AP4	5.95	704A	1.98	1636	5.95	Z225	1.95	5Y3GT	.38	6S7GT	.72	12SK7GT	.60	81	1.28
5BP1	1.95	705A	2.95	1638	.98	OA2	1.69	5Y4G	.50	6S8GT	.72	12SK7GT	.60	82	.88
5BP4	4.95	706BY	24.95	1641	.79	OA3/VR75	.98	5Z3	.88	6S8GT	.72	12SL7GT	.88	83	.88
5CP1	3.95	706CY	24.95	1642	.98	OA4G	1.06	5Z4	.88	6S8GT	.72	12SN7GT	.80	83V	1.06
5CP7	13.95	707A/B	24.95	1654	1.98	OB2	2.05	6A3	1.06	6S8GT	.72	12SQ7	.54	84/6Z4	.60
5D21	29.95	708A	7.95	1665	.98	OB3/VR90	.75	6A6	.88	6S8GT	.72	12SQ7GT	.54	85	.72
5FP7	3.95	709A	9.95	1851	1.26	OC3/VR105	.75	6A7	.72	6S8GT	.72	12SR7	.72	89	.72
5GP1	9.95	713A	1.65	1852	1.06	OC3/VR150	.75	6A8	.88	6S8GT	.72	12SR7GT	.72	99V	1.28
5JP1	11.95	714AY	14.95	1853	1.06	OO	.50	6A8G	.72	6S8GT	.72	12T3	.98	99X	1.28
5J29	29.50	715A/B	19.95	1963	.95	OY4	.88	6A8GT	.72	6S8GT	.72	14A4	1.06	117L7GT	1.42

You've asked for it...  
**AND HERE!  
 IT IS!**

**VALUES ON ALL  
 RADIO EQUIP-  
 MENT AND RADIO PARTS  
 FOR YOU!**

The biggest selection of Radio and Electronic bargains you have ever seen! Every item that Hershel offers you is a value that you can't duplicate anywhere—every dollar that you invest brings you more returns than you ever dreamed possible, so don't delay—stock up today on all Radio and Electronic equipment and parts that you've been waiting to get!

**AZIMUTH CONTROL  
 MN 52H  
 49c  
 MY 178**

Dial calibrated  
 360 degree face,  
 ideal for antenna  
 rationalizing indi-  
 cator. 60 to 1  
 ratio with switch.



**T-17  
 CARBON MIKE  
 89c LIKE NEW  
 MY 160**

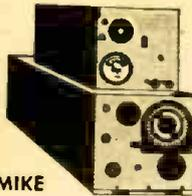
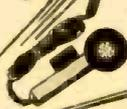

**BC-AR230 TRANSMITTER**  
 Including 4 tubes and RF Ammeter.  
**BC-AL229 RECEIVER**  
 Including 6 tubes. Used in aircraft.  
**BOTH UNITS ONLY My 105**

**\$9.95**

**304TL  
 TUBE 89c**

Just the tube for  
 that 1KW final—  
 typical operation  
 2500 volts at 400  
 MA. An ideal  
 tube for that induction heater or  
 dielectric heater. Efficient opera-  
 tion at 1500V. to 3000V.



**TUBES**

B15...\$1.95	7BP7...\$1.49	9004...\$ .44	6X60...\$ .95
3AP1... 1.95	9LP7... 2.95	9006... .44	114... .44
3BP1... 1.95	VR150... .69	50E5... .89	3Q4... .44
5BP1... 1.95	955... .65	35W4... .69	354... .44
5FP7... .95	9002... .44	872A... 1.95	1N5... .69
5BP4... 1.95	12X3... .44	1M5...\$ .69	VT25
			(210)...\$ .44
			6R7... .44
			3Q5... .69
			6L6GA... .95
			5U4G... .44
			2X2... .95
			6SA7... .44
			8016... 1.49

**C E PHOTOCELL . . . . .95c**  
 Type used in movie projec-  
 tors, burglar alarms, etc.

**SOCKETS**

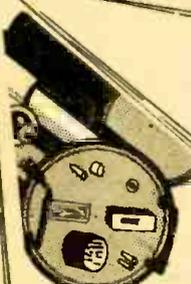

**RT 39-A RECEIVER  
 AND TRANSMITTER**

APG 5 contains: (1)829, (1)2C43, (1)2C40,  
 (1)2X2A, (1)Adjustable vacuum shorting gap,  
 (1)1N21B Xlat, (1)5Y3, (2)9-3, (1)VR105,  
 (8)6AK5, (1)6AL5, (1)Blower, IF strip, can be  
 used on television. This equipment brand new  
 and in original sealed carton.

**\$24.95**

**JOHNSON PORCELAIN  
 SOCKET 25W.  
 4 PRONG**

**25c**



**POR-  
 CELAIN SOCKET  
 829-832 ETC.**

**MY  
 301 3 for \$1**

**PORCELAIN SOCKET  
 (ACORN)**

**14c  
 MY  
 302**

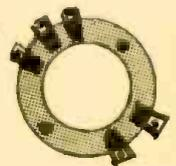

**HERSHEL RADIO CO.**

5249 GRAND RIVER

DETROIT 8, MICHIGAN



**IMPORTANT NOTE**

All orders F.O.B. Detroit—Minimum order \$2.00—Michigan customers  
 add 3% sales tax—20% payment must accompany all orders.



# ULTRA HIGH-FREQUENCY TRANSMITTER AN/APT 5 Brand New!

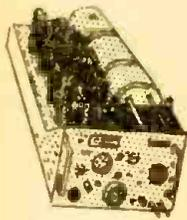

1500 MegaCycle Transmitter, made for U. S. Government, complete with the following tubes: 2.6AC7, 1-6L6, 2-829, 1-931A, 1-6AG7, 1-522 Ultra high freq. tube. Complete with high freq. cavity, 1 Blower to cool the 522, 1 time delay relay, 2 filament trans. cond. and many other component parts for ultra high frequency work. It has a frequency checker, complete Lecher wires, with slider and sensitive bulb for checking the wave length. The Lecher wires are so calibrated that the setting of the slider may be read directly in Centimeters. Operates on 115V. AC for filaments only. Does not include any plate supply. The tubes alone are worth many times more than what we are selling the complete transmitter for. Packed in original case—contains instruction book. Wgt. 118 lbs.

ONLY **49.95** MY 450

## HERSHEL RADIO CO.

5249 GRAND RIVER • DETROIT 8, MICHIGAN

### IMPORTANT NOTE

All orders F.O.B. Detroit—Minimum order \$2.00—Michigan customers add 3% sales tax—20% payment must accompany all orders.

### FM RADIO AND TRANSMITTER BC-620-A

20 MC TO 27.9 MC **\$9.95** MY 400

This Xtal controlled FM set has 13 tubes and has dual Xtal controlled channels. It also contains built-in Fil. and Plate Meter. Tubes used: (4)1LN5, (1)1LC6, (1)1LH4, (2)1291, (4)1299, (1)1294. Ideal for communication between trucks, boats, etc. Used, in good condition. Less power supply. Wt. 38 lbs. Complete with carrying case and diagrams.

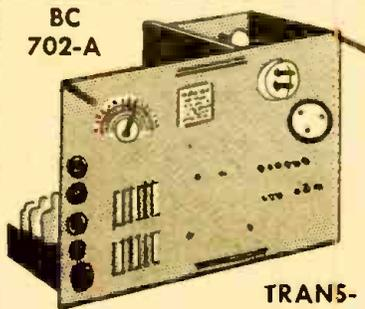

BC 702-A

### TRANSMITTER

ENCLOSED IN A METAL CASE MY 177  
(4) 2X2 tubes, (1) Squirrel cage blower, 12-24V., .02-8000V., 25 MA 2" meter. 2-.01 at 5000 VDC. .001 at 9500V. **\$9.95**

No. MX16 Cross pointer 3 1/4" Meter. Two 200 microamp movements. Brand new. .... \$2.95  
500 ohm to grid matching transformer #B1749. .... 69c  
Ceramic Silver Padders Dual 3 to 12 MMFD or 5 to 20 MMFD. .... 19c  
Ceramic mica Padder single 5 to 20 MMFD. .... per doz. 50c  
Choke—300MA 20HY. Insulated for 5000V. Heavy Porcelain Insulators. Very conservatively rated. Idlc for KW rig. .... \$8.95

### REMOTE POSITION INDICATOR

6-12V. 60 Cy. 5" Indicator with 0-360 Degree Dial. **\$2.45** MY 405

### 3 HY-5MA-325 OHMS

1 1/16" d. x 1 1/4" h. MY 406 **19c**

### PAPER OIL CAPACITATORS

1 MFD 6000 V. MY 407 **\$4.95**  
2 MFD 6000 V. MY 417 **\$8.95**

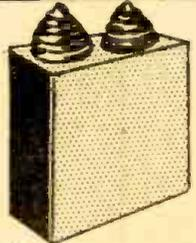

MY 180 **STANDARD BRAND CONDENSERS** **\$1.95**  
.1 MFD 7000 VOLTS

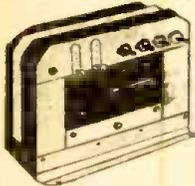

**1 KW MODULATION TRANSFORMER** **\$14.95** MY 111

### LIMITED QUANTITY

RCA Modulation Trans. conservatively rated at 550W. audio to modulate that new KW rig. Audio Watts—550, Sec. 1; 450 mils, Sec. 2; 80 mils turns ratio—Pri: Sec. 1; 1:1, Pri. Sec. 2 Top 25:1. Impedance ratio—Pri: 1-1:1 Sec. Pri: Sec. 2-25:1 Pri: Sec. Top 625:1. DC Resistance—Pri: 135 ohms, Sec #1—112 ohms, Sec. #2—99 ohms, Transformers insulation tested: Pri.—8000V. Sec. #1—11,000V. Sec. #2—2000V. to the rest of the coils and core. Primary center-tapped for Class "B" Modulators. Sec. #2 will carry 80 mls to modulate screens of beam power or screen grid tubes. Primary will match any Class "B" tubes up to 10,000 ohms plate to plate, such as 810's, 751's, 8005's, ZB120's, 203's, HY51Z's, 813's, 828's, 805's, 203Z's. Size: 9 1/2 x 7 1/2 x 7 1/4". Heavy channel iron mounting brackets. Wt: approx. 40 lbs.

### CONDENSERS

Cap MFD	VOLT	Your Cost
2	1000 oil	89c
1	1000 oil	44c
4	600 oil	95c
4	600 oil	69c
2	600 oil	49c

### COAXIAL FITTINGS

HOOD SOCKET 5¢  
SO-239 83-IR 25¢  
PLUG PL-259 35¢  
M-359 83-ISP 20¢  
ANGLE-ADAPTER 83-IAH

**POTTER & BRUMFIELD OVERLOAD RELAYS** **\$1.95** MY 161

Potter and Brumfield. Relay #1—5000 ohms, coil current 10 MA. Relay #2—110V. 60 Cy., AC coil. 5PDT.

### CHASSIS

Size: 19c EA.  
9 3/4 x 4 x 1 1/2" 6 FOR \$1.00  
MY 408

### INVERTER

AUTOMATIC CHANGE-OVER RELAY MY 409 **\$1.49**  
115 V. 400 CY. A.C. 26 V.D.C.

## ATTENTION! — 500,000

Assorted type plugs and connectors too numerous to mention!! Send in your requirements for our extra special, rock-bottom prices!

### WAFFER SWITCHES

MY 154 **KIT OF TEN SWITCHES** **\$1.85**

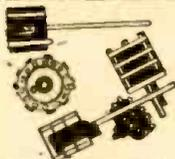

### SELSYN MOTORS

**TWO FOR \$3.95** MY 402  
The ideal way of indicating the position of Rotary beams, wind indicator, etc. Line chord and instructions for 110 AC operation furnished on request.

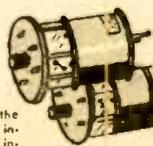

**DUAL VARIABLE COND.** 89c MY 430



### IGNITION COILS FOR STANDARD BRAND Photo Flash Tubes

MY 401 **\$1.29**  
Primary: 150V, condenser discharge. Secondary: 15,000V. can also be used on model airplanes.



### SPERTI R.F. VACUUM SWITCH

9200 Volts peak 8 amps. Used as antenna switch. **95c** MY 403



Discharge resistor Thyrite type 5F 130V. AC or DC 95c  
Resonance ind. neon bulb and alligator clip. .... 19c  
Paper Cond. .05, .05, .05, 300VDC—round can. 1"x1". Dozen. .... \$1.00

**30 MC-1F SILVER-SLUGGED** MY 412 **29c**

### NEW BC 223 AX TRANSMITTER

MY 109 **\$29.95**  
801 Oscillators and 801 power amplifiers, 2-46 modulators and 1-46 speech amplifier 4 Xtal frequencies and master oscillator on selector switch. 10 to 30 Watts output. Tone voice or C.W. Mod. Ideal for 80 meter band. Comes with 3 coils TU 17A 2000-3000 Kc, TU 25 3500-5250 Kc. Black crackle case. Includes two separate cases to store extra coils. Frequencies chart and tubes included, packed in original cases, less crystals at this low price.

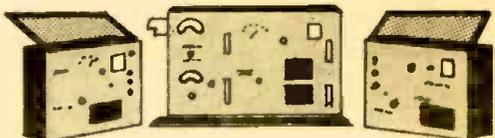

WRITE FOR FREE BULLETINI.

**RADIO RECEIVER BC733D \$9.95**

A part of aircraft blind landing equipment manufactured by WE. Operates on any one of its predetermined Xtal controlled freq. in the range of 108-120MC. Contains 10 tubes, 3 of which are WE 717A's and Xtal. Ideal receiver for conversion to 144MC Ham Band or mobile telephone bands. For 24VDC operation. 1 1/2" x 7" x 4 3/8". Complete with tubes.

**INVERTER - MG 149-F**

24 V.D.C., Dual output 26V. 60 Cy., 250 volt amperes. 115V. 400 Cy. 500 volt amperes. Single phase.

MY 170  
\$14.95  
WILL OPERATE WITH RADIO COMPASS SCR 269-F

**MICA CAPACITATOR MY 166**  
002. MFD.—3000 W.V.D.C. 69c

**FILAMENT TRANSFORMER**  
110V., 60 Cy. Sec. 1; 4V. at 16 amps, Sec.2; 2.5V. at 1.75 amps, insulated for 5000V. Ideal for 2X2 and 826 tubes. MY 145  
Hermetically sealed. Size: 6x3 1/2 x 4 1/2 L. \$1.95

**A-5 AUTOMATIC PILOT—\$4.95**

Serve—100 foot pounds max., to use as a steering device, or compass control on ships.

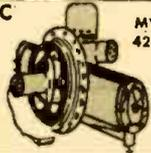

MY 422

**PLATE SENS. RELAY \$1.49**  
5000 ohm, coil contact D.P.S.T.

**TELEPHONE TYPE, PLATE SENSITIVE RELAY \$1.95**  
MY 421 7000 ohm, S.P.D.T., coil contact, S.P.S.T.

**SCOPE TRANSFORMER**  
MY 104 Primary 110V. 60 Cy. Secs \$3.95 4000V. of 10 MA. Size 6x4x3 1/2".

**HIGH-SPEED PHOTO-FLASH TUBE \$5.95**  
MY 156

12,000,000 lumens light output. Stops all action, ignition coil included on back of bulb. 10,000 flashes. Diagram furnished on request.

**ARR7 AIRBORNE VERSION OF HALLICRAFTER SX 28A**  
MY 112 \$129.00

With 3 RF stages. (One re-radiation suppressor R.F.) 12 tubes. Motor and manual tuning. S-meter. F-selectivity control, Crystal Filter, AVC, phasing control, ANL, etc. Also furnishes video output for scope, and panoramic output for scanning. Complete with tubes and Xtal, but without power supply. Power requirements, 270V, at 135 MA. New, in sealed cases.

**SQUIRREL CAGE BLOWER \$7.95**  
MY 169

2" outlet, 110 AC, 60 Cy. Silent Oil lite bearing motor, with mounting bracket.

**CERAMIC INSULATORS HIGH VOLTAGE FEED THRU \$1.00**  
DOZ. MY 103

**COPPERWELD WIRE \$2.95**  
MY 150 3000 FEET

**DYNAMOTOR UNIT \$2.95**

Duo output Dynomotor input voltage 12 to 24V., output voltage 400V. at 135 MA, 800V. at 20 MA, and 9V. at 1.1 amp.

**SIGNAL CORPS KEY 39c**

A good sturdy key for those who still prefer to "pound brass." Shorting switch, heavy contacts, fully adjustable gapping and spring pressure.

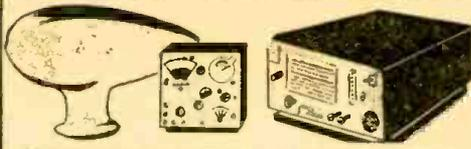

**BRAND NEW AUTOMATIC DIRECTION FINDER**

**RADIO COMPASS SCR 269-F COMPLETE WITH COMPONENT PARTS \$75.00**  
MY 100

The Radio Compass SCR269F was designed to be the primary radio navigation compass for the United States Army and Navy Air Forces. Constant reception is possible day or night so that fixes can always be made to establish the ship's or plane's position. Plotting fixes is accomplished by selecting two or more stations and plotting these on the navigation map. The point of intersection of these lines indicates the location of the craft. This equipment comes complete with 17 tubes and superheterodyne receiver which is tunable from 200 to 1750 KC in three bands. A complete instruction book for operation and maintenance accompanies this equipment.

**STANDARD BRAND TYPE HE 49c**  
MY 147  
100W. Bleeder consisting of 3 sections; 750 ohms, 23 ohms, 23 ohms, 7500 ohms, 3000 ohms, Total—11,296 ohms.

**IF TRANSFORMER 95c**  
MY 115  
Mounted in aluminum shield can. 5 MC with air trimmer, impedance coupled type. DISCRIMINATOR TRANSFORMER TO MATCH.....95c

**THORDARSON CHOKE \$2.45**  
MY 152  
At 200 MA. Shelled case. 10 HY or 15 HY at 150 MA.

**CORONA BALLS 39c**  
MY 116  
Grid and plate connections for VT 127-250 TH etc. Ball Type. Heat dissipating silver plated. 10c EA. \$1.00 Doz.

**TRANSFORMER 95c**  
MY 148  
Audio oscillating transformer with output and feedback winding.

**VOLTAGE REGULATOR—95c**  
MY 141  
Carbon pile, magnetic type, coil current, 105 MA. Load max. 5 omgs at 18.25V

**DON'T MISS THESE SPECIAL SAVINGS!**

Powdered iron, 3/4 slug.....my118.... 10c  
Jacks for PL55, or PL68.....my119.... 10c  
Ass't mica condensers—per 100.....my120.... \$ 1.95  
Pin straightener for miniature tubes.....my122.... 25c  
Ear phones, 2000 ohms, used.....my124.... 95c  
SCR625 Mine detector, used.....my127.... \$39.50  
75,000-ohm 200 watt Bleeder Res.....my413.... 95c

**SILVER CERAMIC CONDENSERS 12c ea. 10 for \$1.00**  
500 W.V.D.C.  
Available capacity (MFFD's), 2, 3, 4, 5, 7, 8, 10, 11, 12, 15, 24, 25, 40, 45, 50, 51, dual 60, 70, 72, 75, 80, 81, 95, 100, 120, 470, 500, and 1000.

**5-GANG VARIABLE CONDENSER \$1.95**  
MY 149  
5 Gang approx. 50 MMFD per section with individual air-tuned padders. 18 to 1 vernier drive. Shielded.

**PYRANOL CAPACITOR**

1 MFD, 5000 VDC, MY 132  
Size: 4x4 1/2 x 3 3/4" \$2.95



**CHASSIS \$1.95**  
MY 150  
Containing: 6V. AC relay, 3 miniature sockets with tube shields, 5 condensers and 6 res. Size: 3x5x1".

**BK 22 K RELAY \$2.95**  
MY 110  
Used in conjunction with SCR269F, change-over contains 28V. step relay 5 deck, 6 position switch, 12V. DPST.

**DETROLA RECORD CHANGER \$12.45**  
MY 311  
Handles 12—10" records or 10—12" records. Automatic changer.

**ANTENNA DUPLEXER \$5.95**  
Originally used on BNIFF equipment to allow the use of a common antenna for receiver and transmitter. 156 to 187 MC..... \$5.95

**ANTENNA \$9.95**  
BOTH UNITS ONLY MY 310  
2 meter antenna: 157-187 MC. Originally used with BNIFF equipment—successfully used on 144 MC as a non-directional antenna..... \$5.95

**MODULATION TRANSFORMER AND DRIVER TRANSFORMER \$4.95**  
BOTH UNITS ONLY MY 302  
RC 1206 modulation transformer. B15 Class A82, 56W. audio. RC 1205 driver transformer, 6SN7 to 815, Class A82—Companion to RC 1206.

**TOGGLE SWITCH 39c**  
MY 151  
DPST. 30 amps, in Bake-a-life case.

**LIP MIKE 95c**  
MY 131  
WITH HEAD BAND AND CORD

**BC-654A PORTABLE RECEIVER AND TRANSMITTER \$14.95**  
MY 114

The frequency range of both transmitter and receiver is continuous from 3700 to 5800 kilocycles; all stages gang tuned by anti-backlash worm gear dial mechanisms. The BC654-A is 18" wide, 14" high, and 9 1/2" deep. Weight—44 1/2 lbs. Power required for receiver—1.5, 45, and 90V. Power required for transmitter—1 1/2, 6, 51, 84, Volts DC and 500. Volts DC at 160 MA. Used.

**HERSHEL RADIO CO.**

5249 GRAND RIVER • DETROIT 8, MICHIGAN

All orders F.O.B. Detroit—Minimum order \$2.00—Michigan customers add 3% sales tax—20% payment must accompany all orders.

# The Future of Radio and Television

## A Radio Authority Looks Ahead

By R. C. COSGROVE, Guest Editor

**I**T AFFORDS me genuine pleasure to cede this space this month to Mr. R. C. Cosgrove, Vice-President of the giant Avco Manufacturing Corporation and General Manager of its Crosley Division—one of the foremost radio manufacturing corporations in this country. Mr. Cosgrove recently delivered an address: "The Present and Future of the Radio, Television, and Appliance Business," before the National Electrical Wholesalers Association Convention at Buffalo.

From this address I have excerpted the major portion of his remarks. Coming from an expert, they will be, not only of great interest, but highly inspiring as well, to all readers.

—H. Gernsback

"More than 31 million radio sets were produced from the end of the war to January 1, 1948. More than half of these (about 19 million) were produced in 1947 alone—a record year for the industry. Thirty-seven million, or more than 90% of American homes have at least one radio receiver, and many have three or four. Five million automobile radios and millions of portables are in use. Altogether Americans currently own more than 65 million receivers. (Latest figures would run to more than 75 million.—*Editor*)

"Now, it is misleading to look at these figures and say that the market for radios is becoming saturated. On the contrary, any business that enjoys such universal appeal with the buying public should constantly provide a ripe market if it is a turnover business, and radio definitely is a turnover market. There are millions of console radios and radio phonographs in use today that are from six to ten years old. This replacement market is untapped.

"Hundreds of thousands of new homes are being established this year. Somewhere I have noted that a million and a half marriages will take place. Based upon our 93% figure, this should mean a market for a lot of new radios. Also, the radio industry's campaign for a radio in every room is making definite headway, opening up markets for additional millions of sets. We estimate that, with a free flow of materials, at least 14 million radios will be produced in 1948.

"The broadcasting industry is continuing to serve as a major stimulus to radio sales. New stations going on the air since the end of the war have raised the total to over 1,700—almost twice the number in operation before the war. Construction permits and pending applications represent another 300 stations, which will mean more than 2,000 in operation in the near future.

"We have developed radio to a fine point. No other industry has achieved greater scientific success. But by no means all the frontiers of radio have been opened. We have yet to develop, for instance, a truly personal radio. I mean one that you can carry on your wrist, in your purse, or in your vest pocket. When a dependable receiver of this kind is placed on the market—and it will be—you will have another new untapped source of sales.

"Another development of promise is very small radio equipment for two-way conversation between individual users. Almost all technical hurdles in this field have been cleared. 'Transceivers,' as they are called, which weigh only two and one-half pounds and are no bigger than a camera, have been approved by the Federal Communications Commission. With a transceiver of this type you can talk back and forth with another party as much as eight miles away. It is the 'walkie-talkie' principle made usable for the public. It is a part of your future in radio.

"Before the war, about 4,000 television receivers were

made and sold. Attesting to the reliability of the industry, even in its earliest public step, is the fact that most of these 4,000 receivers are still giving good service.

"In 1946, 6,500 television receivers were produced. In 1947, 175,000 were produced. Now, here is an indication of the expansion taking place today. In the first four months of 1948, more than 160,000 television receivers were built, or almost as many as for all of 1947. We expect at least 600,000 sets to reach the market this year.

"By the end of this month, 29 television stations will be operating in 19 cities. Seventy more permits to build stations have been issued by the Federal Communications Commission, and 192 applications are pending in 96 cities. By 1949, stations will be operating in 40 cities—supplying programs to areas representing 60% of the nation's population.

"Great strides have been made in the past 60 days in television programming. As a result, you are going to see a sharp upswing in demand for home receivers. Some newsreel companies have arranged to furnish daily newsreels to television stations. NBC is photographing its own newsreels of world events. And many local stations will televise local news by the same means.

"For some time, a network of stations here in the East has been telecasting historic events from Washington and New York. Millions have experienced by television the rare thrill of watching the President of the United States deliver major addresses to the Congress. Already, more Americans have seen President Truman by television in one day than saw Lincoln in public appearances during his entire term.

"Network facilities are moving along briskly, but the job is tremendous and can't be done overnight. Seven thousand miles of facilities are now installed or under construction. Another 7,000 miles will be started as soon as possible. Coaxial cable will reach as far west as St. Louis by the end of 1948. Other tie-ups between cities are being made by microwave relay. The West Coast should be linked with the East Coast by mid-1949. Meanwhile, the West Coast stations are not standing still. They, too, are linking themselves together for improving the shows they put on the air.

"Television is not for the few—it is for the many. It is destined to become as much a part of the American household as radio has become. Surveys have shown that television is by no means a 'rich man's toy.' Three separate, impartial surveys in the nation's major television area—New York and its boroughs—have proved that by far the largest percentage of television sets are owned by families with middle, and lower middle, incomes.

"The latest survey showed that 73½% of sets in the New York area were owned by families in the average income group. 26½% were owned by those in the high income group.

"Sets on the market today range from those with 7-inch picture tubes, which give a picture some 4 x 6 inches, to projection-type receivers giving a picture as big as a newspaper page. Prices range from less than \$150 for small table sets, to \$2,500 or more for large, opulent consoles.

(As we go to press, Pilot Radio Corporation announces a \$99.50 television set with 3-inch tube.—*Editor*)

"What we are now experiencing in television is not a 'boom,' as some have called it, but a logical and stable expansion. Barring defense emergencies, television for years to come will be a rapidly growing, major business. Most estimates on the retail value of annual receiver production by 1952 run around \$675,000,000. In the next five years, I expect to see television at least a billion-dollar industry."

**THE MOON AFFECTS** radio transmission, according to a report last month by Dr. A. G. McNish of the National Bureau of Standards. It is well known that propagation is affected by the sun, but recent observations show that the moon is also a factor at certain times in certain parts of the world.

At Huancayo, Peru, where the effect is very pronounced, maximum usable short-wave frequencies averaged 1.7 mc lower three or four days after new moon than after the first or last quarter.

Dr. McNish explained that just as the moon raises tides in the ocean, it produces tides in the atmosphere and in the ionosphere. This explanation, however, is not deemed sufficient by itself and more investigations are under way.

**STRATOVISION** tests conducted last month by Westinghouse engineers from a high-flying B-29 were highly successful. With television transmitting and receiving equipment installed aboard the plane, pictures and sound sent out by ground stations in Baltimore, Washington, and other cities were picked up and rebroadcast from the bomber.

**JOHN F. RIDER**, well-known publisher of radio books, received a silver plaque last month from New York's

With the aircraft at altitudes up to 10,000 feet, the rebroadcast signals (sent out on channel 8) were received at surprising distances with excellent picture and sound quality. The engineers say that it will be possible to get good reception within a radius of 200 miles from the transmitting craft.

The first stratovision experiments were made over 2½ years ago, the recent tests proving conclusively the capabilities of the system. Westinghouse is developing it as a television relay method in competition with co-axial cable, unattended relay stations, and other systems.

**ULTRASONIC VIBRATIONS** force the evolution and growth of new kinds of plants and insects, *Science Service* reported last month.

The vibrations were produced at 400 kc by electrically driven crystals. They were used on three different kinds of plants and on young fruit flies. Subsequent growth showed genetic changes in the plants and insects and alterations in the heredity-carrying chromosomes.

presented at a regular meeting of the association attended by 1700 servicemen, was "in grateful appreciation of his



President Max Leibowitz of ARSNY presents a plaque to author and publisher John F. Rider.

radio repairmen, acting through their organization, the Associated Radio Servicemen of New York, Inc. The plaque,

meritorious achievements in behalf of the radio service industry during the years 1921-1948."

**ELECTRONIC PUSH BUTTONS** are used in a new elevator call system announced last month by Otis Elevator Company. The push buttons at each floor resemble the ordinary type, but do not move when pressed. Instead, the presence of the passenger's finger causes a current flow in a small electron tube located in the plastic button housing. The current makes the elevator stop when it comes to the floor. The tube lights up to indicate the call.

The new control simplifies elevator system installation by doing away with about 40 relays in a typical 20-story building, as well as reducing the necessary wiring. Elimination of many mechanical parts cuts down failures.

**RADIO RECEIVER SALES** dropped sharply in the New York area during the summer, according to dealer reports. Practically the only sets selling well were the portables.

**TV COMMERCIALS** have obstructed any merger between television and the motion-picture industry, according to a statement made last month by Howard Dietz, vice-president in charge of advertising and publicity of M-G-M. He predicted that ultimately movies and TV would get together, but not as long as programs were sponsored.

Mr. Dietz warned that television was about to repeat the errors of radio by presenting only programs which can sell goods. He advocated a system where viewers would pay for programs or some method of keeping the advertising separate from the program material.

### WATCH FOR THE NEW, IMPROVED RADIO-CRAFT

COMMENCING with the September issue **RADIO-CRAFT** will appear in a new dress. It will not only be printed on high-quality paper assuring good reproduction of illustrations, but it will also have color on a number of editorial pages. A number of other eye-appealing improvements will also be made in the magazine, including better printing.

In addition to all this the magazine will be increased in size to 100 pages, thus giving the readers more interesting and valuable editorial material.

Don't miss the coming issues of the new improved **RADIO-CRAFT** for up-to-date information in the radio and television field.

**HIGH-FREQUENCY TV** plans were announced last month by RCA. The company will construct an experimental television transmitter in Washington, D. C., to operate just above 500 mc to permit gathering information on u.h.f. video transmission.

Radiating on a channel of 504-510 mc, the station will have an output of 25 kw. It will duplicate programs of WNBW, Washington NBC television outlet, so that picture quality and reception conditions on the 500-mc band can be compared directly with those on the 66-72-mc channel on which WNBW operates.

The station will be installed at the Wardman Park Hotel where the WNBW transmitter is located.

**45-MINUTE RECORDS** containing entire symphonies on two sides were demonstrated last month by Columbia Records. The new discs are made of vinylite and are played at 33 1/3 r.p.m. instead of the usual 78.

Known as Columbia LP (Long-Play-



Dr. Peter C. Goldmark, Engineering Director, CBS, inspects a gold-sputtered master.

ing) Microgrooves, the records are made with pitches of 224 to 300 grooves per inch, in contrast to the maximum of about 100 on present records. The high cutting pitch, together with the slower speed, provides the long playing time.

Although the discs cannot be played with standard pickups, present home radio-phonographs can be equipped to reproduce them with a small, inexpensive player. This contains a slow-speed turntable and a pickup. The pickup is a newly-developed type of Rochelle salt reproducing cartridge with a semi-permanent stylus of one-third the tip radius of standard needles. The needle pressure is only one-fifth ounce—far lower than that of any previous pickup. In conjunction with the frequency curve used in making the records, it will produce high-fidelity, wide-range response when connected to a flat amplifier. The player was developed by Columbia and Philco.

**A PERSONAL TV RECEIVER** retailing for less than \$100 was demonstrated last month by Pilot Radio Corporation.



The new "personal television receiver" which provides a picture for one or two viewers.

The set, called the Candid T-V, contains a 3-inch picture tube. The aluminum cabinet measures 14 x 9 1/2 x 13 1/2 inches, and it can be carried from room to room (a leatherette carrying case may be obtained). The small viewing screen makes it especially suitable for personal use, since the viewer can sit close to the set.

Twenty-one tubes are used and all 13 channels are covered. A switch changes tuning from the low to the high television band, and tuning on each band is continuous. Though the manufacturer has furnished no details, the tuner is said to use variable condensers, heretofore not used in v.h.f. television tuning circuits.

**PHILO T. FARNSWORTH**, Utah-born major figure in television development, was honored last month by the University of Utah and Brigham Young University. A medal from the University of Utah was accompanied by a citation "for outstanding achievement in the field of science." At Brigham Young University he was guest of honor at a special "Farnsworth Day" celebration.

**JOHN MILLS**, inventor, author, and retired Bell Laboratories executive died June 14 at the age of 68. Mr. Mills, originally a teacher at the Massachusetts Institute of Technology and Colorado College, wrote the pioneering text on radio, widely used by the Signal Corps during the first World War. He was instrumental in developing the magazine *Bell Laboratories Record*, and was the author of books on atomic physics as well as on radio subjects. Two of his most recent books were *Electronics Today and Tomorrow*, and *The Engineer in Society*.

**BLIND RADIO TEACHER** and amateur, Robert Gunderson, W2JIO, was honored last month at a luncheon tendered him by the Association for the Education of the Blind on completion of his 13th year as a radio teacher.

The blind radio teacher has trained several hundred sightless radio repairmen and has helped over seventy to prepare for FCC amateur exams. His amateur activity is intense—he is operating four stations in New York and New Jersey at the moment—and he is also a radio inventor and consultant.



**McMURDO SILVER** died at his home near Hartford, Connecticut, June 18, 1948. Forty-five years old at the time of his death, Silver was known to all radio-men as a veteran designer, constructor and engineer as well as a manufacturer of high-grade radio components and more recently of test equipment. He was head of McMURDO Silver Co., Inc.

Always a pioneer and never an imitator of others, many of his original developments were adopted and became standard over the whole radio field.

McMurdo Silver's first contribution to the radio art was the design of circuits which made the superheterodyne practical. Early superhets used a low intermediate frequency (30 kc). Silver conceived the idea of using a much higher frequency and avoiding the difficulties inherent in what were actually super-sonic frequency amplifiers. The Haynes-Griffin superheterodyne, using coils designed by Silver, had an i.f. of 100 kc and was the first of the modern supers.

In the mid-twenties, he combined with a distant relative to produce the famous Silver-Marshall line of high-grade radio receivers and later manufactured a line under his own name. These *Silver Masterpieces* were multiband radios which combined the features of high-class broadcast sets with communications receivers.

More recently he was connected with Guthman Co. and with Fada Radio, of which company he was for a time vice-president. At the time of his death he was manufacturing test instruments for the radio repairman.

Besides radio, McMURDO Silver's hobbies included yachting, polo and old guns. His collection of the latter was extensive, and he was an authority on the history of the Colt revolver. He was a member of the IRE and the Radio Club of America.

**HAMS** of the West Gulf Division, ARRL will hold their 18th annual convention in Houston, Texas, August 20, 21, and 22. ARRL headquarters representatives and members of the FCC, Army, Navy, and research departments of several universities will speak.

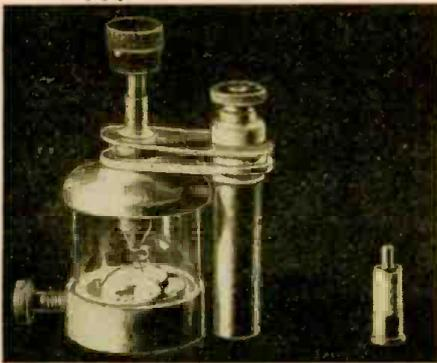

Fig. 1—Compare the IN21 and its early predecessor with adjustable catwhisker.

# The Crystal Detector

Part II—Crystals developed for radar are the results of experiments over many years

By JORDAN McQUAY

**M**ODERN crystal cartridges—now widely used for detecting, mixing, rectifying, and other functions—had their inception in the historic but simple crystal detec-

tors (Fig. 1) that were once a part of every radio receiver. Development of the vacuum tube ended the crystal era, and by 1934 galena and carborundum detectors were toy novelties. The efforts of

early experimenters were all but forgotten. With vacuum tubes of greater efficiency, there was no need for crystal detection in receivers operating at ordinary radio frequencies.

In 1934, Bell Telephone began experiments at their Holmdel, N. J., Laboratories to explore the possibilities of using microwaves for communication purposes. Results of these early investigations clearly indicated that it might be possible to raise the upper limit of usable radio frequencies. Evidently, many new operating techniques would be required for microwave reception. In particular, detection posed a problem.

Because of limitations imposed by interelectrode capacitance and electron transit-time effects, vacuum tubes would not function adequately at frequencies above 5,000 mc, and thus could not be used to detect microwave signals.

Since transit-time effects as well as capacitance effects are negligible in contact rectifiers, the merits of the almost-forgotten crystal detector were reconsidered. It proved to be the only satisfactory means of detecting extremely high-frequency radio waves.

This 1934 search for suitable materials was somewhat simpler because of the exhaustive investigations conducted by Pickard and other pioneers at the turn of the century. Engineers of the Bell Laboratories examined and tested over 100 materials and metalloids, but only silicon and iron pyrites were found suitable for microwave detection. A point contact hard enough to prevent formation of large contact areas under normal contact pressure was required. The metals finally chosen for the point contact were a platinum-iridium alloy and a fine tungsten wire—sometimes coated with a gold alloy.

Subsequent experiments were concerned with improving the rectifying material, the rectifying surface, the point contact, and the method of mounting or housing the crystal detector.

Many kinds of crystal rectifying devices were designed and used successfully at the Bell Laboratories during the following years. An indication of the wide variety of types and structures is

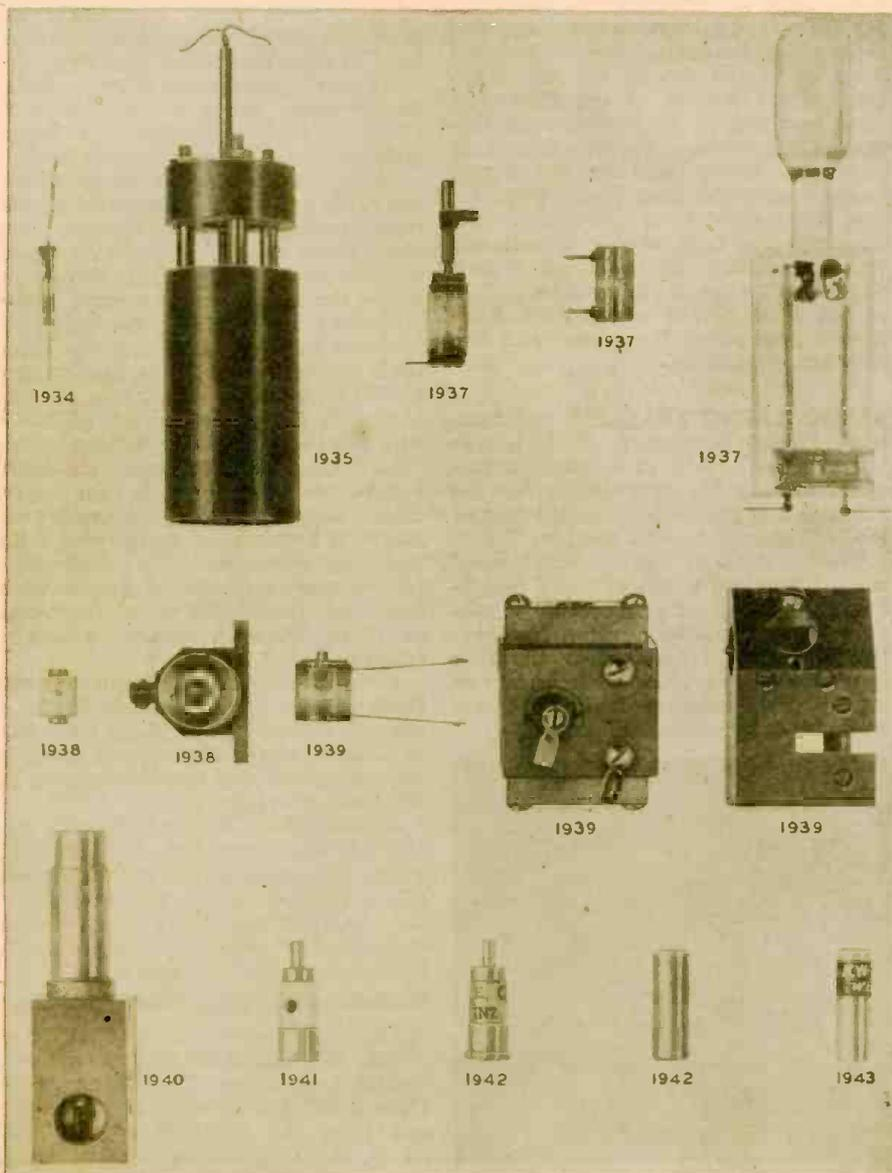

Fig. 2—Crystal holders are often designed as an integral part of an electronic circuit.

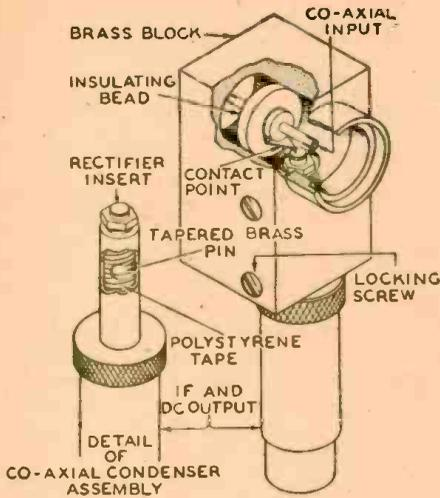

Fig. 3—Early crystal converter assembly.

given in Fig. 2. Designs were generally dictated by the requirements of laboratory apparatus. Often the crystal housing was an integral part of some electrical circuit. Other structures took the form of replaceable cartridges.

**Mounting blocks**

An outstanding development of the Holmdel Laboratories, prior to 1940, was a crystal detecting arrangement consisting of a rectifier insert and a point contact, both of which were demountable and standardized. When used with a device known as a crystal mounting block (Fig. 3), the arrangement functioned as a mixer (or first detector) in the frequency-converting circuits of microwave receivers. In this way, a comparatively simple crystal rectifier alone provided i.f. signals within practical range of the u.h.f. superheterodyne receivers.

The rectifier inserts consisted of small wafers of silicon or iron pyrites, about 1 mm in diameter and 1 mm in depth, soldered directly to brass studs. Silicon gradually replaced pyrites, since silicon inserts showed less effects of frequency.

By about 1939, knowledge of silicon metallurgy was sufficiently advanced so that a uniformly active contact surface could be produced, and patient searching for active spots was no longer necessary.

These crystal mounting blocks were used in many centimeter-wave experiments prior to 1940. Somewhat similar apparatus was employed by Southworth and King in their celebrated experiments with 25 electromagnetic horns.

The demountable rectifier inserts and associated contact points also were used as straight detectors, as rectifiers for u.h.f. test and measuring instruments, and for other purposes. But the ability of crystal rectifiers to function as frequency converters in microwave superheterodynes was the chief reason for their development during the war years which followed.

**An urgent war need**

The outbreak of war greatly accelerated a vast national program of research and development of microwave radar equipment. There was an urgent need for a standard type of highly sensitive crystal rectifier, to be used for frequency conversion in radar superheterodynes at wave lengths of only a few centimeters.

Earlier in 1941, the British had developed for their radar receivers a small cartridge-type silicon mixer-detector<sup>2</sup> which pronouncedly influenced the shape

and size of the first crystal cartridges developed in this country. The trend of American design was toward a more stable and sensitive silicon detector in cartridge form, with the rectifying contact adjusted and fixed during manufacture, so that crystal cartridges could be interchanged and replaced easily. Also, simplicity of construction was desirable for mass production.

Following these general specifications, work was begun by a number of development organizations, including the Radiation Laboratory of the Massachusetts Institute of Technology and the Bell Laboratories.

In the work at Bell, the shape and external features of the British cartridge were retained, but considerable changes in process and design were introduced to improve performance and simplify manufacture.

Important changes included the substitution of fused high-purity silicon for the "commercial" silicon of the British detector, to obviate any need for searching for active spots on the contact surface and to improve general performance; use of diamond saws to cut the rectifying element from silicon ingots, and subsequent preparation of the contact surface by careful polishing and etching; and development of a special impregnating compound to protect the cartridge from moisture and mechanical shock.

The result was the ceramic rectifier cartridge, which was soon standardized

Fig. 4—(Below) Cut-away and exploded views of a ceramic rectifier cartridge. Fig. 5—(Right) Crystal detectors were used as frequency converters or frequency changers in radar systems for bombing and navigation in B-29 bombers.

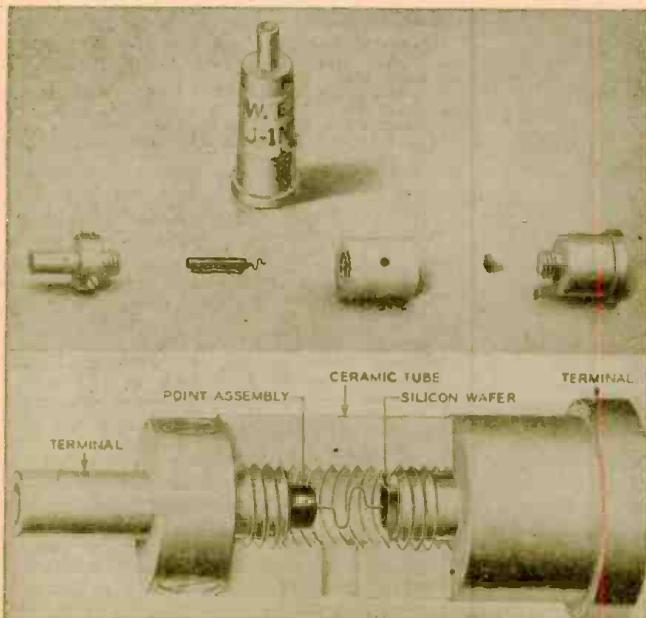
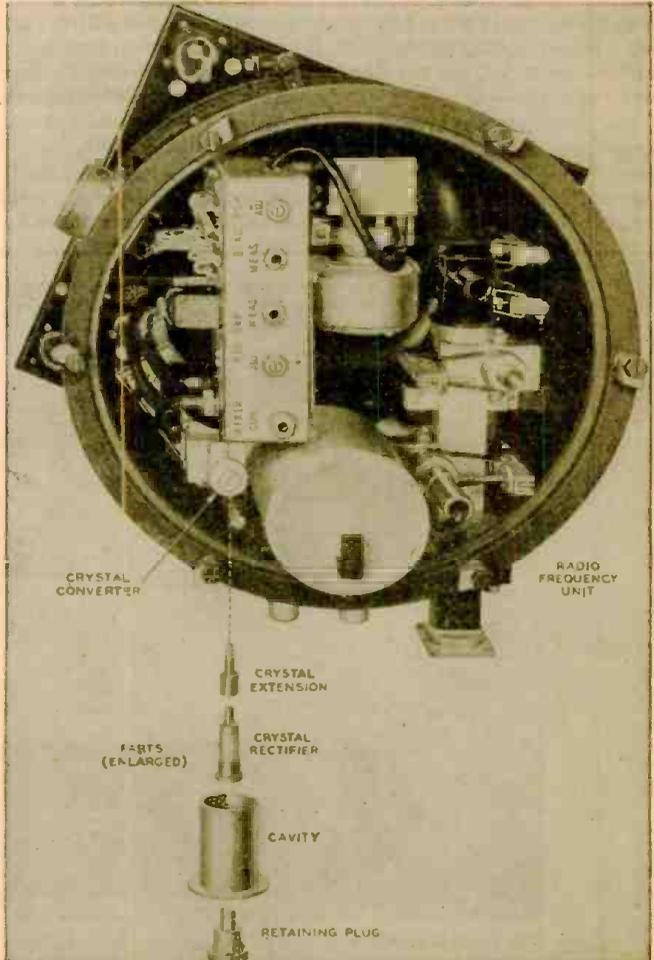

and is substantially the same today as when first manufactured nearly seven years ago.

### Ceramic rectifier cartridge

Components of the ceramic rectifier cartridge (Fig. 4) include two metallic terminals separated by a ceramic insulator. The rectifying element is a small wafer of silicon soldered to the lower base terminal. The contact spring is attached to a cylindrical brass pin which is locked in position by setscrews. This spring is made of gold-plated tungsten wire formed into an S. The free end of the wire contacts the polished surface of the silicon, and the tip is formed electrolytically. The point usually is cone-shaped to maintain a contact of small area.

After assembly, the rectifying contacts are adjusted for optimum operation. The crystal cartridge is then impregnated with a special *gel* filler, consisting of a wax dispersed in a hydrocarbon oil. This compound prevents mechanical changes in the contact point due to temperature contraction. Since it excludes moisture, the compound also prevents electrical changes and serious point corrosion due to high humidity.

As a final stage in manufacture, the efficiency of a crystal cartridge is improved by striking the side of the cartridge sharply with a small hammer. This simple procedure, known as *tapping*, also reduces high-frequency conversion loss and noise. However, the tapping operation is not a haphazard search for a better rectifying contact, for, with a given material, the reaction is regular and reproducible.

Despite their apparently delicate construction, ceramic rectifier cartridges have high resistance to mechanical and thermal shock. For example, production tests include dropping the unit 3 feet

onto a wooden surface, immersing it in water, and rapid heating from subzero to high temperatures. *None of these tests impairs the quality of the rectifier.*

### Use of the cartridge

As a mixer or frequency converter, the crystal rectifier has no competition at frequencies above 3,000 mc. It has a frequency response hundreds, and sometimes thousands, of times wider than that of vacuum tube or other dry rectifiers, and requires no heater or plate supply voltages.

In application, the rectifier cartridge produces a difference (intermediate) frequency between the r.f. signal and the local oscillator, which is then amplified and detected in later stages of the superheterodyne.

A typical use of the ceramic rectifier cartridge as a frequency converter in an airborne radar system is shown in Fig. 5. This equipment was used in all B-29 bombers for navigation and for radar bombing.

Similar types of crystal cartridges were used as low-power rectifiers in wave meters, probes, and other test equipment. Special types were developed for direct detection of the video envelope of r.f. signals at low power levels. They have a distinct advantage over selenium rectifiers, since they require no appreciable time to establish blocking action.

Some types for use at frequencies up to 100 mc have a current-carrying capacity from two to three times greater than the 6H6 vacuum tube. These crystal rectifiers are used as second detectors in superheterodynes, clippers, limiters, diode modulators, and for many functions normally accomplished by diode tubes.

Although used widely and successfully in many applications, ceramic cartridge rectifiers have certain limitations.

In particular, they are susceptible to damage by discharge of static electricity through the point contact. Also, during manufacture, necessary close control of mechanical dimensions is extremely difficult. To eliminate or minimize these limitations, the shielded rectifier cartridge<sup>1</sup> was developed.

### Shielded rectifier cartridge

Components of this improved crystal cartridge are shown in Fig. 6. The rectifier terminates a small co-axial line. The rectifying material is soldered to a small brass disc, which is fixed in position and connected to the sleeve or outer conductor of the co-axial line. The central conductor—insulated with a bakelite cylinder—terminates in a tungsten wire .002 inch in diameter and formed into a spring. The cone-shaped free end of this spring is in contact with the polished surface of the rectifying material.

The contact point being inside the outer conductor, it is effectively protected from accidental static damage as long as the outer conductor is grounded. The sleeve also shields the rectifying contact from stray radiation.

Although developed in 1942, the shielded rectifier cartridge was not produced and used on a large scale until much later in the war, when its advantage over the ceramic type was demonstrated conclusively. It is likely that most future crystal rectifier cartridges will be shielded.

As the result of research initiated at Purdue University and continued by various laboratories, shielded cartridges using germanium as the rectifying material are available for relatively high-power operation. These rugged types are used for power rectification, d.c. restoration, pulse generation, and other heavy-duty purposes. Further development in this field will eventually produce crystals capable of superseding all diode vacuum tubes and other rectifying devices.

### References

- "Crystal Rectifiers and the Rise of Radio," Jordan McQuay, *RADIO-CRAFT*, Vol. XIX, July, 1948.
  - "Metal Horns as Directive Receivers of Ultra-Short Waves," G. C. Southworth and A. P. King, *Proc. IRE*, Vol. 27, Feb., 1939.
  - Crystal rectifiers produced by British Thomson-Houston Co., Ltd.
  - "Development of Silicon Crystal Rectifiers for Radar Receivers," J. H. Scaff and R. S. Ohl, *Bell Sys. Tech. Jour.* Vol. 26, Jan., 1947.
- OTHER BIBLIOGRAPHY:**
- "Ultra-High-Frequency Techniques," Brainerd, et al., Van Nostrand, 1942.
  - "Principles of Radar," Staff of MIT Radar School, McGraw-Hill, 1946.
  - "Crystal Rectifiers," Radiation Laboratory Series, Vol. 15, McGraw-Hill, 1948.
  - "H. F. Crystal Diodes," H. A. LeDuc, *RADIO-CRAFT*, Vol. XVII, Mar., 1946.
  - "Crystal Rectifiers," W. E. Stephens, "Electronics", Vol. 19, July, 1946.

### ACKNOWLEDGEMENT

Grateful acknowledgement is made to the *Bell System Technical Journal* and the *Bell Telephone Laboratories* for permission to use historical information and reproduce certain photographs, which originally appeared in the January, 1917, issue of the *Bell System Technical Journal*.

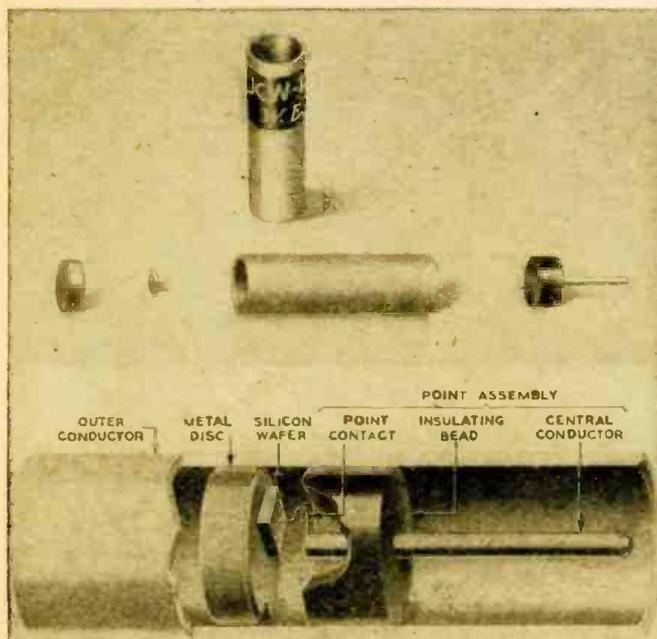

Fig. 6—This rectifier is protected against static by outer conductor.



# Image Magnifier Amplifies Light

**A** STEP TOWARD the long-dreamed-of electron telescope is the image amplifier tube recently developed by the X-ray Division of Westinghouse at Baltimore. This tube is intended to brighten the fluoroscopic images used in X-ray examinations.

Fig. 1 shows how the magnifier tube works. X-rays which have passed through the patient's body, just as in a standard fluoroscope, strike a fluorescent screen. Behind this screen, on which is produced the image of the patient's organs, is a layer of photoelectric material. Each point on the photoelectric surface emits electrons in direct proportion to the brightness of the segment of the fluorescent screen facing it.

The electrons emitted by the photoelectric surface are accelerated and focused by the electronic lenses, to which a high potential is applied. They strike a second fluorescent screen at the small end of the tube. Here the image is much brighter than on the original fluorescent screen for two reasons. First, the acceleration of the electrons has caused them to strike the small screen with great force. This gives a brightness gain of 20 times.

Second, reduction of the image on the small screen to one-fifth the size of that on the large screen increases the brightness. Since the same number of electrons strike the small screen as come from the large, their confinement to a smaller area increases the brightness of any given area. The brightness increases inversely as the square of the image size. Since in this tube, the image size is reduced by a factor of 5, the brightness is increased by the square of 5, or 25.

Combining the two increases in brightness—20 due to electron acceleration and 25 due to size reduction—the total brightness gain is 500. By using an ordinary optical magnifying lens system to examine the small screen, the physician sees the image effectively in its original size.

The present development is by no means a telescope since it reduces the size of the image to increase brightness. However, television scanning techniques could be used to break the picture down into a series of elements which could be amplified to any extent.

Limitations of the optical magnification that can be obtained without loss of brightness make it unprofitable to reduce the electron image to less than one-fifth the size of the X-ray image in the present design. The electrostatic acceleration

has been held to a gain of 20 times to keep the tube's length down.

The conditions that confront the physician in present day fluoroscopy are even worse than those encountered in finding a seat in a movie after leaving bright sunshine. He has to dark-adapt his eyes for twenty minutes to see the fluoroscopic image. Even then with the low brightness available in difficult cases, such as a large abdominal thickness where the brightness may be as low as .00005 millilamberts, a separation of  $\frac{1}{4}$  inch is necessary before contours can be distinguished. Furthermore this  $\frac{1}{4}$ -inch figure applies only in measurements where the contour lines separate regions with a contrast of 100%, as in contours between black and white. While this is an extreme case it compares with 30 millilamberts brightness and .001 inch contour separation as normal conditions for observing X-ray plates. A brightness of .001 millilamberts with a required contour separation of  $\frac{1}{32}$  inch is the center of the fluoroscopic range.

With the image amplifier tube attached to his equipment the physician will step into his dark room and see at once an image almost as bright as on a movie screen. He may still have to dark-adapt his eyes, though for only three or four minutes, before he can see all the details. What he sees after that will be a clear, easily discernible feature presentation of his patient's organs at work.

The future possibilities for amplified fluoroscopy are impressive. Both patient and doctor will save time and cut down on the period during which they are



Lenses and screens revealed in cross-section.

exposed to direct and scattered X-rays. Even televising fluoroscopic images may well become practical. The physician

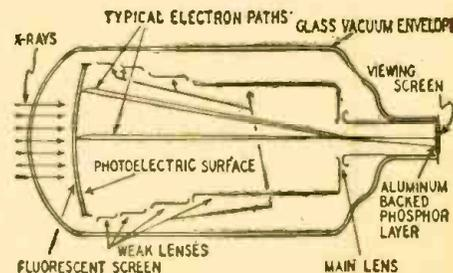
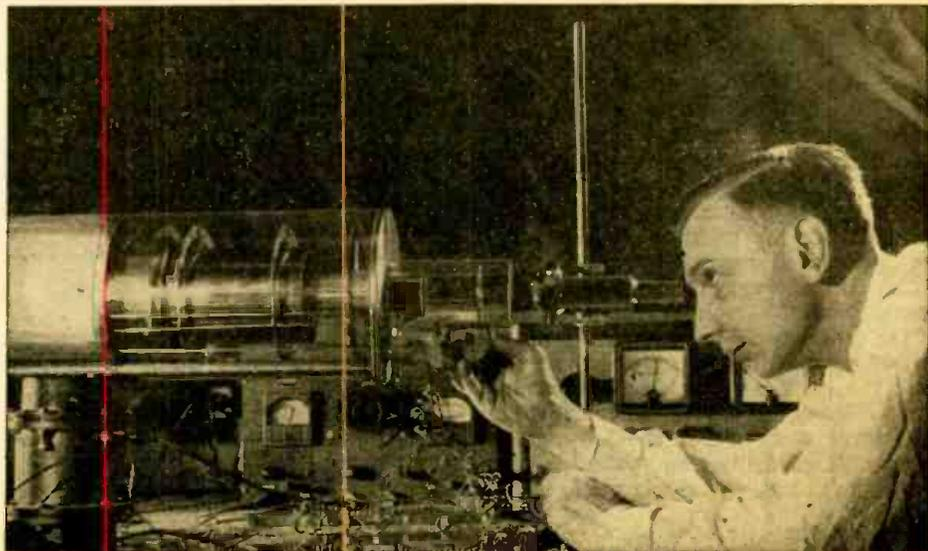

Fig. 1—X-rays strike the fluorescent screen, releasing electrons which are accelerated by the lenses, striking the smaller screen with great velocity and making a brighter image.

will be able to perceive objects at present indiscernible.

The image amplifying system is just emerging from the research stage. Westinghouse engineers warn that many months of perfection and design engineering remain to be done before the device is commercially available. The research has, however, irrefutably proven that it is practical and important.



Dr. J. W. Coltman of the Westinghouse Laboratories adjusts the focus with a magnet.

# Television Power Supplies

Receivers now on the market may have any one of several high-voltage supplies that differ in principle as well as in detail

By E. J. BUKSTEIN

THE availability of cathode-ray tubes on the war surplus market and the expansion of television broadcasting have emphasized the need for obtaining the high d.c. potentials required for C-R tube operation. The potential required depends on the size of the tube: it may vary from 1,000 volts for the small 2-inch tubes to 30,000 volts for the tubes used in projection television receivers. There are several problems which do not exist in low-voltage supplies. Transformer insulation and inverse peak voltage ratings of the rectifier tubes are the most important.

Since the beam current of a cathode-ray tube normally runs well below a quarter milliampere, the need is for a high-voltage, low-current supply. This reduces the problem of filtering, because the amount of filtering necessary is a function of current drain. Since current requirements of the cathode-ray tube are very small, the filter condensers used in the high-voltage supply are considerably smaller in capacitance than those used in low-voltage supplies. However, the voltage ratings of these condensers are of great importance; they must be adequate to prevent voltage breakdown.

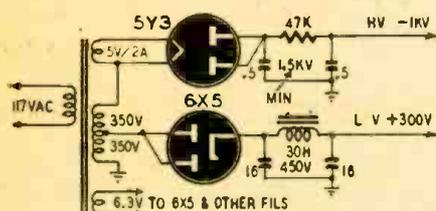

Fig. 1—A supply for a 2- or 3-inch C-R tube.

The supply shown in Fig. 1 utilizes an ordinary receiver-type power transformer and can develop approximately 1,000 volts. It is satisfactory for 2- or 3-inch cathode-ray tubes in television receivers or oscilloscopes.

The transformer used in Fig. 1 delivers about 350 volts r.m.s. each side of the center tap. Since the high-voltage secondary winding is grounded at one end, 350 volts is available at the center tap. The center tap is connected to a half-wave rectifier for the low-voltage supply. A good filtering system is necessary to reduce the ripple voltage sufficiently.

The total secondary value is 700 volts r.m.s., which is fed into a half-wave rectifier for the high-voltage supply.

Note that the a.c. is fed into the cathode of the rectifier tube, resulting in a negative output from the high-voltage supply. This is quite conventional, as cathode-ray tubes are often operated from negative (grounded positive) power supplies. Because the cathode-ray tube will draw only a small amount of current, the voltage output is equal to almost the full peak value of the 700-volt input, or approximately 1,000 volts. Also, since the current drain is small, an R-C filter employing 0.5- $\mu$ f condensers is adequate.

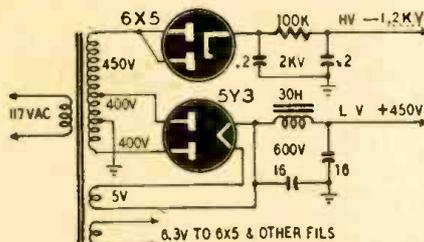

Fig. 2—Dual supply with special transformer.

The supply shown in Fig. 2, typical of those found in commercial oscilloscopes, requires a special power transformer. The high-voltage secondary winding is conventional except that it is continued at one end to give an additional 450 volts. The conventional portion of this secondary winding (400 volts each side of center tap) is connected to an ordinary full-wave rectifier circuit for the low-voltage supply. Here again the filtering should be adequate.

The top of the secondary is connected to a half-wave rectifier. The cathode is 850 volts (400 plus 450) above ground. Because of the small current drain, the output voltage is approximately the full peak value of 1,200 volts.

Five-inch cathode-ray tubes such as the 5BP1, 5CP1, 5CP7, 5UP11, etc., require high-voltage power supplies delivering approximately 2,000 volts. This

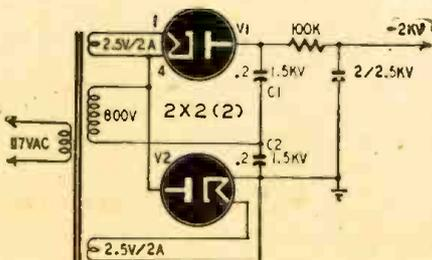

Fig. 3—A voltage-doubler gives 2,000 volts.

voltage may be obtained from an ordinary receiver-type power transformer used in a voltage-doubler circuit (Fig. 3). Note that the center tap of the high-voltage secondary winding is not used. This permits use of the full end-to-end voltage, which will be in the order of 800 volts r.m.s.

As the diagram shows, one end of the high-voltage winding is connected to the cathode of one rectifier tube and to the plate of the other. When this end of the winding is negative, tube V1 conducts, charging condenser C1. When it is positive, tube V2 conducts, charging condenser C2. Thus C1 charges on the negative alternations and C2 on the positive alternations. These condensers charge to the peak value of the a.c. input; and since they are connected in series, the total voltage across both of them is over 2,200.

A type of high-voltage supply increasingly popular in television applications is shown in Fig. 4. This is the r.f. power supply. It is equally useful for oscilloscopes. The only basic difference between this circuit and a conventional power supply is that r.f. is being rectified, rather than the usual 60-cycle line voltage. As shown in Fig. 4, the output of the r.f. oscillator is stepped up by an r.f. transformer. This high-voltage r.f. is then rectified and filtered in the usual manner. The magnitude of the output voltage is determined primarily by the design and turns ratio of the r.f. transformer. These transformers are commercially available in ratings as high as 50,000 volts. Filtering is comparatively simple. Since the ease of filtering de-

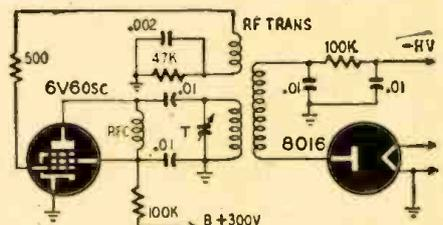

Fig. 4—R.f. supply needs little filtering.

pends on frequency, and since the ripple frequency in this power supply is equal to the oscillator frequency, small filter components can be used with a saving of money and space.

Another very common type of power supply, the inductive kick-back type, was very fully described in RADIO-CRAFT in January, 1948, and will not be further discussed here.

COVER FEATURE

# "FLYING SPOT" C-R TUBE

A new lantern for many television chores

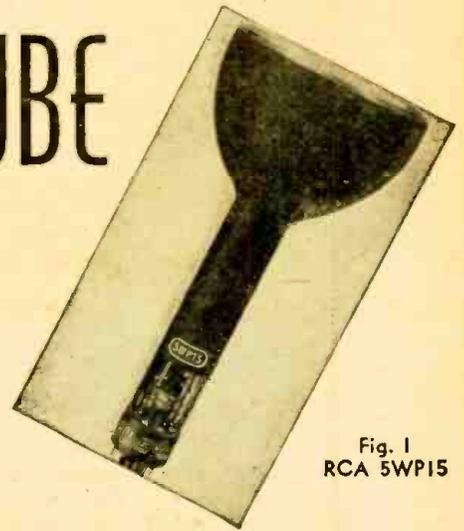

Fig. 1  
RCA 5WP15

TELEVISION station call letters, test patterns, and pictorial program material may be broadcast, without using expensive and elaborate studio cameras, with the help of the recently designed "flying-spot" cathode-ray tube shown on our cover. Any transparent or opaque slide can be transmitted with the half-tone fidelity of photographic film.

The new tube is not a camera tube, but is a source of light, and is very much like an ordinary cathode-ray picture tube. The extremely intense spot of light which travels over its face is projected through a transparent slide containing the picture. As the spot scans the slide, the light variations produced by the picture are picked up by a multiplier phototube and transmitted as video signals.

The tube, designated 5WP15 by its makers, the Radio Corporation of America, is shown in Fig. 1. It is about 11 1/2 inches long, and the flat fluorescent face is 5 inches in diameter.

Fig. 2 shows how the tube is operated to transmit the picture from a transparent slide. The spot travels just as in the standard television system—525 lines interlaced, 30 frames per second.

The flying spot is focused on the slide, over which it travels, by the objective lens. As the spot passes through each portion of the slide, the transmitted light varies with the density of that portion of the picture. The light strikes a multiplier phototube type 931-A, whose output corresponds at every instant to the intensity of the portion of the slide

picture being scanned. This phototube output is the video signal which is then sent to the transmitter for radiation.

The flying-spot principle is not new—it was one of the first systems of television transmission used in experiments. A rotating disc and light source produced the flying spot. It is, of course, much simpler and less expensive than an iconoscope. Until the development of the new 5WP15, however, an all-electronic flying spot was not used, due to several operating difficulties.

One of these troubles was "trailing." When a cathode-ray tube is made with most ordinary phosphors, there is an appreciable time delay in the buildup and decay of light. When the electron stream strikes a particular spot on the screen, a certain time is required for visible light to appear. If this held true in a flying-spot scanning system, the phototube would not receive the full amount of light as soon as the spot moved from a dark to a light area of the slide. The light would build up only gradually, and the received picture outlines would be blurred—the black areas would trail over into what should be a white area.

Decay of the light on a particular spot of the tube face also took time with the old-style cathode-ray tubes. If that were true in this system, the phototube would still be receiving some light after the spot had passed from a white to a black area of the picture. The white in the received image would then tend to trail over into the black. The trailing in previous systems could be remedied to a large extent by high-frequency equalization in the video amplifiers following the phototube. However, complex and costly equalizers would have to be used.

The new flying-spot tube uses a phosphor known as P15, which has extremely short persistence, to reduce trailing. In addition, most of the light emitted is near the ultra-violet region, in which persistence is much shorter than in the visible region. This reduces the trailing further. To achieve the maximum benefit, an optical filter is used to screen out all rays except the ultra-violet. This filter is shown between the condenser lenses and the phototube in Fig. 2. With this arrangement only one inexpensive high-frequency equalizer need be used in the amplifier to give a clear picture and an excellent signal-to-noise ratio.

This month's cover shows an actual system using the flying-spot tube. The engineer is adjusting the knob which sets the height of the tube for proper focusing of the spot on the slide, which is in the projector-type housing just above it. The phototube is mounted behind the slide, instead of the lamp which

would be there in a slide projector.

On the same chassis as the slide housing is a video amplifier into which the output of the phototube is fed. Above that is a chassis containing a 20,000-volt power supply for the flying-spot tube and a scanning amplifier. Controls are provided for vertical and horizontal frequency, size, centering, linearity, and electrical focus of the spot.

At the top is equipment for synchronizing signal amplification and a 900-volt regulated supply for the phototube. A 350-volt supply is in the bottom of the rack. Ordinarily, this 7-foot rack, which contains everything necessary for operating the flying-spot transmission system, is covered with steel panels.

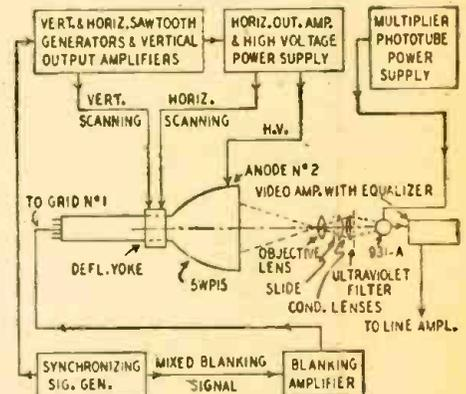
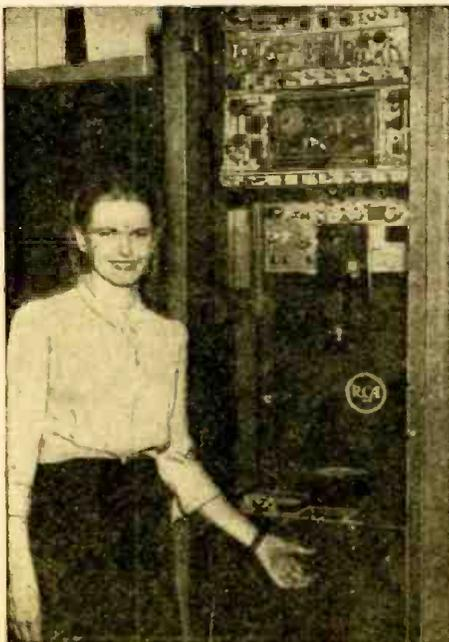

Fig. 2—Block diagram of flying-spot system.

When opaque pictures are to be transmitted, operation of the system is very similar to that used with transparent slides, except that the phototube picks up the light reflected from the picture instead of that passing through it. With opaque pictures, the signal is not quite as strong as with transparencies.

Interesting effects can be obtained using flying-spot scanning for pictures or titles used as program material. One picture, for example, can be superimposed on another. To do this, the flying-spot tube, instead of giving a constant-intensity light spot, is modulated by a picture signal. The light caused by this first picture, which appears on the tube face, is then transmitted through the slide to the phototube. The phototube output contains both signals, one superimposed on the other.



RCA's Carolyn Tufts adjusts the tube's height.

# Radio-Frequency V. T. V. M.



Sloping-panel mounting improves appearance.

**M**ANY radio measurement problems can be solved efficiently with an r.f. vacuum-tube voltmeter. For those who build their own receivers, the voltmeter makes accurate stage-gain measurements possible. It will show instantly if the local and beat oscillators are operating and with what efficiency.

Transmitter power output can be determined by measuring the voltage across a 75-ohm noninductive resistor connected to the output terminals. The power is then calculated by the formula:

$$W = E^2/R.$$

Adding a pickup stub or tuned circuit converts this voltmeter to a very sensitive field-strength indicator.

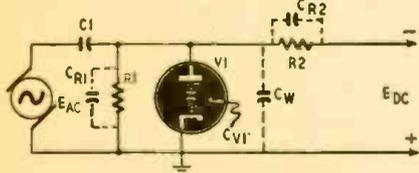

Fig. 1—Problems of h.f. voltage measurements.

The instrument is an a.c. voltmeter which reads accurately between two frequency limits. The low-frequency limit is determined by the input resistance-capacitance time constant, while the high-frequency limit is determined largely by the input shunt capacitance.

In Fig. 1, alternating voltage  $E_{AC}$  causes diode  $V_1$  to conduct on the positive half cycles only. During the negative halves, capacitor  $C_1$ , charged to approximately peak voltage of  $E_{AC}$ , discharges through resistor  $R_1$ . The time constant of  $R_1$  and  $C_1$ , however, is so high that  $C_1$  loses very little of its charge before the next positive half cycle recharges it.

The longest R-C time constant consistent with the lowest frequency to be used is desirable since variable voltage at 60-cycles a.c. is usually the handiest

**A valuable instrument for amateurs, radio servicemen, and constructors**

By A. A. GOLDBERG

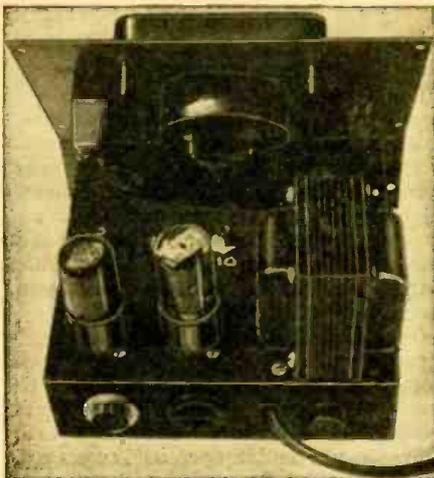

Rear view. The probe is connected at left.

available. Ordinary a.c. voltmeters (which are most accurate at 60 cycles) may be used as calibration standards. The R-C time constant is therefore made long enough to prevent excess charge from leaking off  $C_1$  to cause inaccuracies at 60 cycles.

Certain limitations prevent using a very large capacitor and resistor to make the R-C time constant extremely long. First, the capacitor must have very little leakage, which precludes the use of electrolytics and the larger paper capacitors. The physical size of the large paper capacitors also causes more shunt capacitance which reduces the high-frequency limit.

Capacitance is the most important high-frequency limitation. Any shunt capacitance appears as a reactive component in parallel with the normal input resistance. Since capacitive resistance decreases with frequency, a point is reached where the total input impedance becomes low enough to introduce considerable error. It is therefore im-

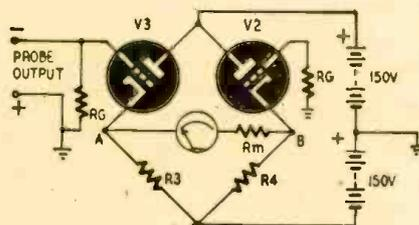

Fig. 2—Fundamental circuit of v.t. voltmeter.

perative to reduce the shunt capacitance to a minimum. These capacitances are the inherent resistor capacitance  $C_{R1}$  and  $C_{R2}$ , diode plate capacitance  $C_{V1}$ , and wiring capacitance  $C_w$ . The first two are minimized by using the smallest metalized resistors available. Using the 6AL5

miniature twin diode keeps capacitance  $C_{V1}$  small. Capacitance  $C_w$  can be kept within tolerable values only if extreme care is used in the construction of the probe.

The probe's voltage output can be fed only into an electronic d.c. voltmeter. An excellent circuit for this purpose is the balanced-bridge type, Fig. 2. The cathode-current drop across  $R_3$  and  $R_4$  causes the static cathode potential to be +5 with respect to ground. Since the grids are at ground potential, the resultant grid bias is 5 volts negative.

Under static conditions, the bridge is balanced and the voltage between points A and B is zero. If the probe output voltage is 100, the grid of  $V_3$  becomes 100 volts negative with respect to ground. This decreases the  $V_3$  cathode current until the voltage at A becomes -95 with respect to ground. As point B is still +5 volts, the difference between A and B will be 100 volts. If resistor  $R_m$  is 600,000 ohms, a 200  $\mu$ a meter will read full scale.

The bridge circuit has several advantages: It is independent of plate-supply voltage variation. It is independent of tube aging, due to circuit degeneration. It protects the meter, if  $R_m$  is too small. Full voltage cannot build up across points A and B.

The actual circuit used is shown in Fig. 3. The second section of the 6AL5 is used to balance out contact potential on one grid of the 6SN7 by applying an equal contact potential to the other grid. Although it is not absolutely necessary, a contact-potential zero control has been provided. This control has a screw-driver adjustment and is mounted below the chassis.

The 6.8-megohm probe resistors are isolation resistors. The resistor between the plates of the 6SN7 prevents any possible parasitic oscillations.

The power supply delivers exactly 300 volts output. If any other power transformer is used, the 6,800-ohm resistor should be adjusted until the output is exactly 300 volts. Two 100,000-ohm 2-watt resistors divide the output into +150 and -150 volts.

There are five voltage ranges: 0-1, 3, 10, 30, and 100. These ranges suffice for most work in which an instrument of this type is used. Multipliers for each range are a combination of approximately 80% fixed and 20% variable resistors. The large variation range per-

mits recalibration in case of tube changes and aging of parts. An a.c. outlet is provided at the rear of the chassis for use by other instruments.

**Constructing probe and chassis**

Instrument efficiency depends largely upon good engineering of the probe. This probe (Fig. 4) requires some lathe work, but the appearance and performance make it well worth while. For those who have no machine tools at their disposal, any local machine shop will turn out for a nominal sum the two simple parts required.

The body of the probe is made from a 3½-inch length of 1-inch outside diameter, thin-wall, dural pipe. Square the ends and remove the burrs. The plastic end is machined from a 2-inch length of 1-inch round polystyrene rod. Drill a No. 28 hole through the center of the plastic for a 6-32 brass screw. Measure the diameter of the .03-µf, 400-volt paper capacitor and bore half way through the polystyrene from the flat end to provide a snug fit when the capacitor is inserted. The rear plug is also made from polystyrene. It may be machined for a press fit into the dural tube to eliminate holding screws. Make sure the hole through which the cable passes is a snug fit.

Insert the front polystyrene part into the dural tube and drill three No. 42 holes, 120 degrees apart, through the dural and plastic. Remove the plastic and tap it for 4-40 screws. Enlarge the holes in the dural to clear the screws. The cable is triple-conductor with shielding braid and rubber covering over all.

A polystyrene socket is used with the 6AL5 tube to eliminate the inconvenience and danger of cracked glass. Solder the resistors as close to the socket as possible, but take care to prevent melting the plastic. Arrange the resistors and leads to support the tube coaxially with the metal probe shell.

The v.t.v.m. is built into a metal 8 x 8 x 8-inch, sloping-front cabinet which accommodates a 7 x 7 x 2-inch chassis. All components are placed for the shortest leads consistent with good wiring practice. The probe receptacle is in the rear directly behind the 6SN7-GT

tube. A surface-mount-type power transformer eliminates the need for cutting a large rectangular hole in the chassis. The power transformer is placed as far as possible from the sensitive meter to avoid demagnetizing it.

Arranged across the middle of the chassis are the five multiplier potentiometers. The fixed-resistor portions of the multipliers are mounted on terminal strips.

The 4-inch square meter has two scales marked 0-10 and 0-30. These are for the 10-, 30-, and 100-volt ranges. The 1- and 3-volt ranges being nonlinear, corrected scales must be used with these two ranges for greatest accuracy. Although these scales can be drawn on the meter face, the author found it more convenient to mount separate correction curves on the front panel. The dial plate and correction curves were reproduced photographically.

**Calibration**

Calibrating the r.f. vacuum-tube voltmeter is simple. Any step-down transformer, Variac, or resistance voltage divider connected across the a.c. line can be used as a source of voltage. One convenient source of low voltage is a universal tapped output transformer. Before starting calibration, obtain a 6SN7 tube with close-matched triode elements, for a better-balanced bridge circuit. Also make sure that the cathode-heater leakage is low in both elements. One way to determine this is to measure the (hot) cathode-heater resistance at the tube socket with an ohmmeter.

Actual calibration is done as follows:

- (1) Set the meter needle to zero with the meter-zero screw.
- (2) Turn the instrument on and allow about 30 minutes for warm-up.
- (3) Disconnect the probe from the chassis, and temporarily connect a 20-megohm resistor from the pin No. 4 grid of the 6SN7 to ground.
- (4) Set range switch on 1-volt scale and zero the meter with the front-panel zero control.
- (5) Reconnect the probe and remove temporary grid resistor.

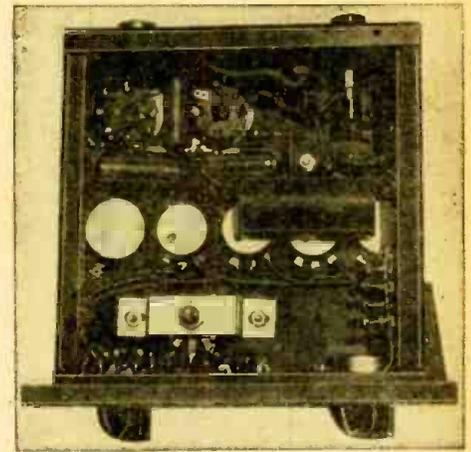

Bottom view shows how the parts are placed.

- (6) With the contact-potential zero control beneath chassis, zero the meter once more. This adjustment balances the diode contact potential.
- (7) With range switch set at 100 volts, feed approximately 80 volts to the probe input. Adjust the calibration control until meter reads correctly. Calibration at the 80% point is the best compromise for any possible error.
- (8) Calibrate the 30- and 10-volt scales in a similar way.
- (9) Because of nonlinearity in the 3- and 1-volt ranges, plot a correction curve of voltage input versus meter reading. This curve may later be transferred to the meter scale, if desired.
- (10) Place a dab of coil cement on the multiplier potentiometer shafts to prevent accidental turning.

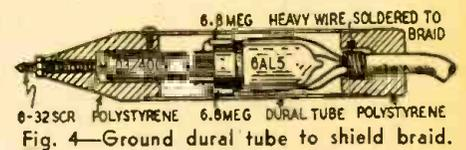

Fig. 4—Ground dural tube to shield braid.

The input capacitance of the probe is 8 µµf. This capacitance may become bothersome at very high frequencies. One way to lower it and raise the input impedance is to connect a 390-ohm metalized resistor in series with the probe. This impairs accuracy slightly, but where the meter is used solely as a peaking device, little is lost.

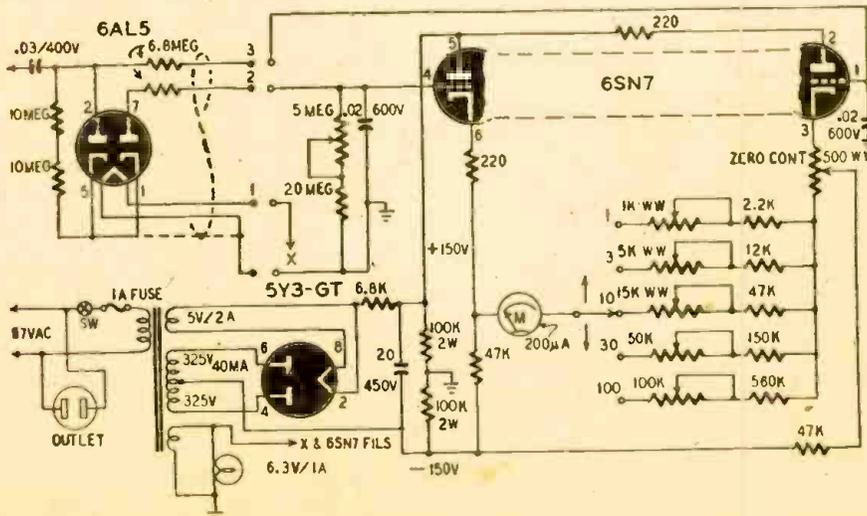
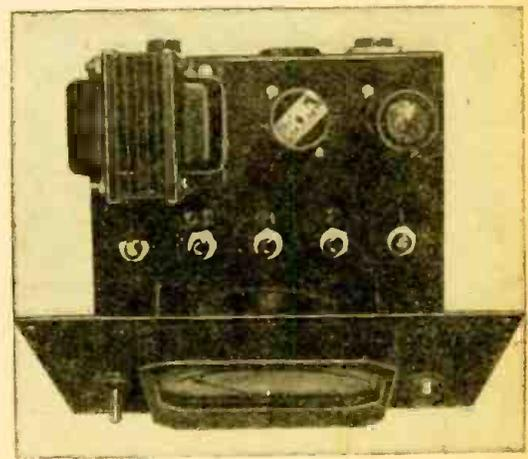
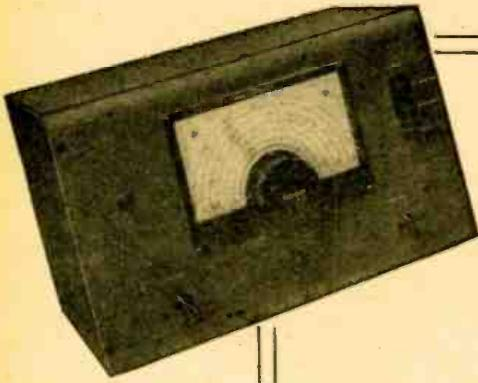

Fig. 3—Complete schematic of the r.f. instrument. Probe connections are 1, 2, 3, and ground.



Top view. The pots are screwdriver-adjusted.



# AUDIO OSCILLATOR HAS SINGLE CONTROL

By RICHARD D. HENRY

**T**HIS audio test generator is simple to operate, easy to build, and inexpensive. It is tuned with a single variable resistor, rather than the usual ganged capacitors or potentiometers. No accurately-matched fixed resistors or capacitors are needed. Only two tubes are used, in addition to the power-supply rectifier. Output level is constant within 2 db from 40 to over 12,000 cycles. Wave form is as pure as that of the best R-C oscillators, which means that almost perfect sine waves are produced.

The circuit, adapted from one published in *Wireless World*, a British magazine, uses a modified parallel-T frequency network. Instead of the special lamps used as cathode resistors in most R-C oscillators to keep output constant, this model employs an amplifier for the purpose.

The diagram is given in Fig. 1. The 6SN7 is a 2-stage feedback amplifier. The frequency-determining components are shown within the dashed box. A 3-circuit 2-position switch selects one of two ranges. The lower covers 40 to 850 cycles, and the higher 850 to over 12,000. R1 is the frequency-control potentiometer and R2 is a trimmer used to adjust the ranges so that they overlap. R1 is a standard audio volume control. Do not use a control with a linear taper, as

this will crowd the high end of the scales. The four capacitors used in the frequency network and the two 22,000-ohm resistors need not be matched; they need be only roughly equal to the values shown.

The coupling method used between the two sections of the 6SN7 is interesting. The right-hand grid is grounded for audio through a 0.1- $\mu$ f capacitor. The 5200-ohm cathode resistor (common to both cathodes) is unbypassed. Audio voltage appears across this as the result of audio changes in the plate current of the left triode.

All that is required to modulate a tube is an audio voltage between its grid and cathode. Usually the voltage is placed between the grid and ground, with the cathode grounded for audio. Here the cathode-resistor voltage appears between the right grid and cathode, but the *grid* is grounded. Such grounded-grid amplifiers are often used today, but usually at v.h.f. and u.h.f.

If the 3,000-ohm variable resistor R3 were reduced to zero, both plates would be at ground potential for audio, due to the bypass capacitor C1. Increasing the resistance of R3 places the right-hand plate slightly above ground, allowing a small output voltage to appear between the plate and ground. This voltage is re-

turned to the frequency-determining network as positive or regenerative feedback. The resistor value is increased until just enough feedback voltage is created to cause oscillation. Too much feedback would spoil the waveform. The amplifier is then kept at the same output by the large grid and cathode resistors. To help equalize the gain of the two triodes, most of the grid resistance is common to both.

Output is taken from the same plate that supplies the feedback. The two 10,000-ohm resistors are a voltage divider, and the voltage taken from between them is R-C-coupled to an ordinary 6J5 amplifier. Although useful output can be taken directly from the 6SN7, the 6J5 prevents a low-impedance load (or one that is not entirely resistive) from having any effect on the oscillator. It also gives a larger output voltage. The output side of the 6J5 is conventional, but it adds the convenience of a low-impedance tap. R4 is the output volume control.

## Construction details

The 15 x 11-inch metal cabinet was on hand, so a 3-inch-high chassis to fit it was procured. This is really much bigger than necessary; a smaller housing and chassis would give plenty of

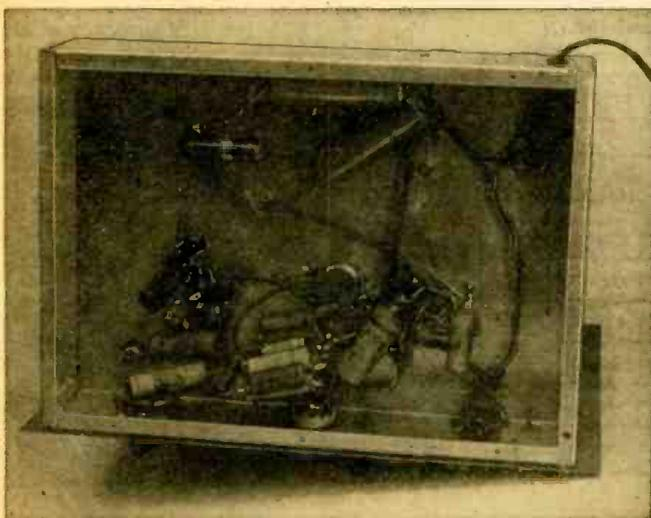

The controls visible in the center are R2 and R3.

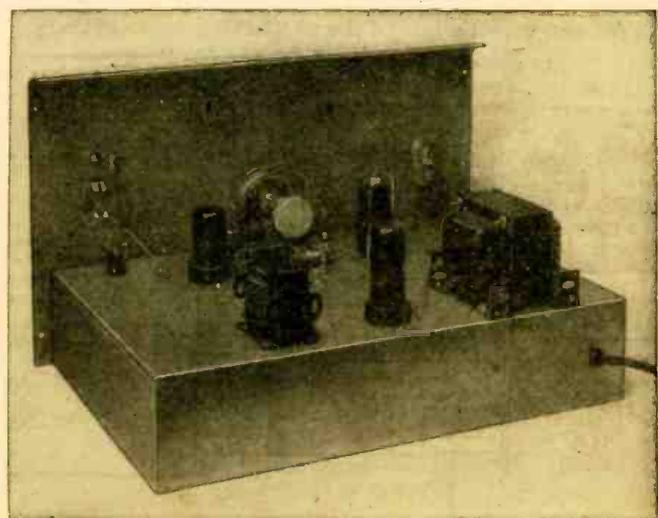

Potentiometer in center controls the frequency.

room for the few components, yet leave more room on the test bench for such other essential items as the amplifier or receiver under test.

The chassis-top view shows the tube layout. The 6SN7 is at the front of the chassis on one side and the 6J5 is on the other. At the rear are the rectifier tube, the power transformer, and the filter choke. If a smaller chassis is used, be sure to separate the two inductors as much as possible from the 6SN7, since the oscillator will tend to lock in with the power supply frequency if there is any hum pickup. The tuning resistor, R1, is mounted on an angle bracket about two inches behind the panel. R3 is beside R1, R2 behind it. Both of these are screwdriver-adjusted.

The under-chassis view shows the parts layout. There is nothing critical here although if leads are too scrambled there may be some instability or undesired oscillation. In the model, the leads from the range switch (which is concealed by the resistor-capacitor mounting board in the photo) were scrambled, but a 100- $\mu$ mf capacitor, C2 in Fig. 1, stopped all trouble. This capacitor may not be necessary in other models. Use no shielded leads.

The dial is a National ACN, again because it happened to be on hand. It poses a slight problem, since it provides for only 180 degrees of rotation, while the tuning potentiometer, of course, has a 270-degree range. This problem is solved as shown in the following paragraphs.

**Adjustment**

After the unit is built and voltages are checked, let it warm up for a few minutes, then set the range switch for the low frequencies. Set R1 in the middle of its range, then slowly increase the resistance of R3 until a tone is heard. Rotate R1 over its range with the switch in both positions. Advance R3 until oscillation is smooth at all times and until an a.c. voltmeter placed across the high-impedance output terminals shows that the ratio of minimum to maximum voltage output at the lowest- and highest-level points does not exceed about 1:1.25 (2 db).

R1 should be connected so that frequency rises with counter-clockwise rotation to take advantage of the taper and spread out the high frequencies. If the ACN or some other 180-degree dial is used, set the switch on the low range and turn the pot slowly to the left. Notice that during the last several degrees of rotation, there will be very little change in frequency. Leave the potentiometer set at the point where the frequency change becomes very slow. Set the dial to the left end of the scale, then tighten the setscrew.

Now see if the lowest note of the top range is lower than the highest note of the bottom range. If not, note the lowest note of the top range, retune to the highest frequency of the low band, and decrease the value of R2 until the frequency is high enough to give overlap. R2 will not have much effect on the

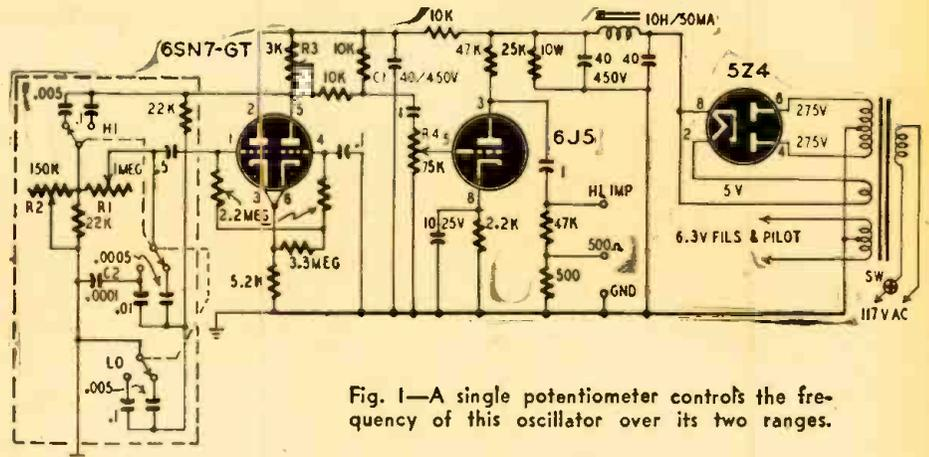

Fig. 1—A single potentiometer controls the frequency of this oscillator over its two ranges.

lower frequencies of each band, but will extend the highest frequencies. In effect, therefore, it extends the coverage of each range. Do not make R2 any smaller than necessary for adequate overlap. It may be necessary to readjust R3.

**Calibration**

Calibration is best done with the aid of a borrowed oscillator with accurate frequency markings, and an oscilloscope. Feed one oscillator to the vertical input of the scope and the other to the horizontal input. Set the borrowed oscillator to 50 cycles, then slowly adjust the new one until a stationary O appears on the scope, indicating that the two oscillators are tuned to exactly the same frequency. Mark this frequency on the dial scale, then go through the rest of the range in the same way. Depending on the precise phase relationship of the two oscillators, the O may be slanting.

If the calibrating oscillator is not continuously variable, the known and unknown frequencies can be fed into the scope and the resulting Lissajou's patterns used to determine the harmonic relationship existing between the two oscillators. Adjust the oscillator to be calibrated so the oscillographic pattern stands still. Count the number of peaks or loops touching the vertical and horizontal axes. The ratio of the numbers is the same as the ratio of the two frequencies.

Calibration by ear is not too accurate, especially at the higher and lower frequencies. In a pinch, however, it can be done. If another oscillator is not available, a piano can be used for a rough calibrator. Middle A is 440 cycles and each octave doubles the frequency.

A scope can be used, of course, without another oscillator, to give multiples of the line frequency.

# Impedance Measuring Methods

By RUFUS P. TURNER

A WELL-KNOWN arrangement for measuring impedance requires only a decade resistance box (or calibrated variable resistor), high-impedance a.c. vacuum-tube voltmeter, audio oscillator, and s.p.d.t. switch. The connections for the test circuit are shown in Fig. 1.

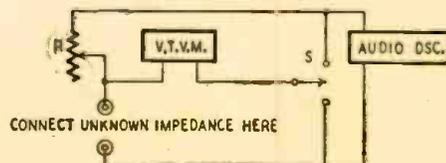

Fig. 1—A standard impedance-measuring setup.

The test procedure is to throw the change-over switch S back and forth, at the same time adjusting the calibrated resistor R. When the meter deflection shows no change as the switch is thrown from one position to the other, the unknown impedance is equal to the resistance of R and may be read directly from the resistor dial.

This scheme is widely used, and presents no difficulty when either the voltmeter or the oscillator is battery-operated. However, when both of these instruments are a.c.-operated (and espe-

cially when they are bypassed internally to the power line), difficulties arise because different points in the test circuit are effectively at ground potential. This has the effect of placing a shunt loop around either the unknown impedance or the calibrated variable resistor.

The circuit shown in Fig. 2 overcomes this difficulty by providing a single ground point which is common to both instruments and to the test circuit. The test procedure when using this circuit is somewhat different. Throw switch S back and forth, adjusting the calibrated resistor R. Stop the adjustment when the voltage read with the switch at position A is exactly one-half the voltage at position B, and read the unknown impedance value from the dial of the calibrated resistor.

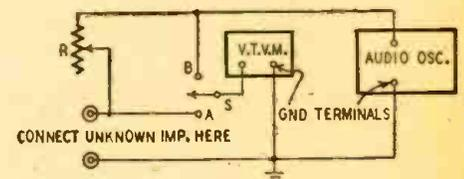
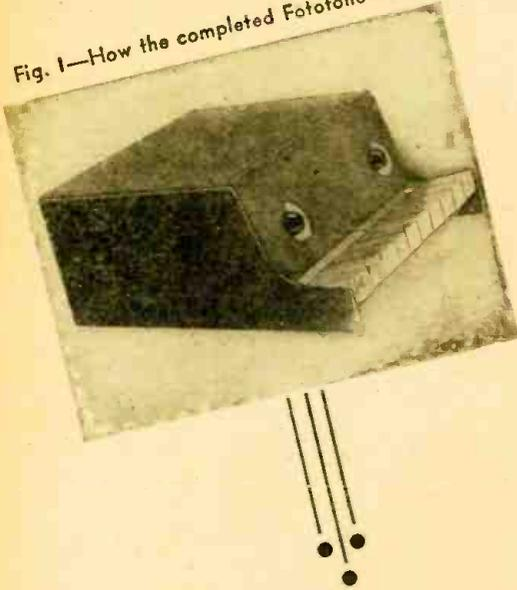

Fig. 2—Improved impedance-measuring method.

Fig. 1—How the completed Fototone looks.



# Electron Music With the Fototone

A ten-keyed instrument which uses  
tone wheel and photoelectric tube

By LYMAN E. GREENLEE

**T**HE Fototone is an unusual musical instrument which—as its name implies—uses the photoelectric principle to produce tones. It is shown in Fig. 1. This case contains the keys, the mechanism, the photocell, and two controls—tuning and volume.

Fig. 2 illustrates the principle by which the instrument operates. A tone disc (shown in the photo, Fig. 3) consists of 10 concentric rings of black diamond-shaped spots. The spots are equally spaced within each ring, but the num-

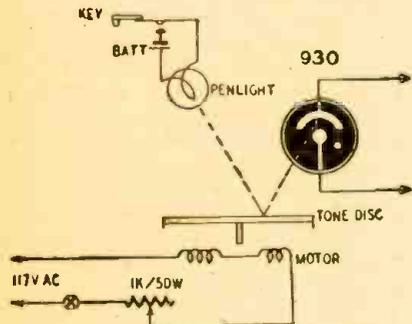

Fig. 2—Reflected light excites phototube.

ber of spots—and the spacing between consecutive spots—in each ring is different.

To return to Fig. 2, the disc is rotated by a motor. The spot of light from a small flashlight lamp is centered on one of the concentric rings. A photocell is placed where the reflection of the light will hit it. When the disc revolves, the reflection of the light from the disc will not be steady; each time a black spot comes under the light spot, there is no reflection. The reflected light pulsates, the pulsation frequency depending on the number of black spots passing under the light spot in a given time.

The photocell picks up these pulsating reflections. Output of the cell is amplified and fed to a loudspeaker, where the pulsations appear as audio tones.

The tone disc is designed so that if the light spot is centered on the inner ring and motor speed is adjusted so that

the note produced is C, the succeeding rings will give succeeding notes of the C-major scale. Since there are 10 rings, the highest note will be E of the next octave. If motor speed is changed so that the lowest note is D, for example, the other notes will form a D-major scale, ending at F-sharp.

In the actual instrument there are 10 separate lamps, each positioned to beam a small spot of light on one of the concentric rings of black spots. The photocell is so placed that all light reflections from the disc will reach it. The tone produced then depends on which lamp is lighted. The keyboard holds 10 keys, each of which is a momentary-contact switch connected to one of the lamps.

Fig. 4 shows the top of the Fototone with the cover removed. The vertically-mounted chassis at the rear contains the preamplifier and wireless oscillator (described later). On its front are the oscillator-rectifier-amplifier tube socket (left) and the phototube socket (right). The lamps are mounted, five in each of two brass holders, so that their light will shine down through the oblong hole

on the tone disc revolving underneath.

At front center the motor is mounted upside down so that its shaft goes through the Masonite base. The tone disc is attached to the shaft just under the base with the spots facing up. At the front left is the rheostat which controls

A tone-wheel cannot be printed without some distortion due to the curved plates used in printing any large magazine. Therefore the authors have arranged to supply accurate discs at a cost of \$1.00. A complete set of blueprints will be supplied with each disc. Address Lyman Greenlee, c/o RADIO-CRAFT, 25 West Broadway, New York 7, N. Y., enclosing a \$1.00 postal note.

motor speed, and at the right the volume control.

Layout for each of the lamp holders is given in Fig. 5. The metal used is thin sheet brass. After drilling the holes accurately, nick them as shown with a small file or hacksaw, and then roll the corners of the nicks in opposite directions to form a rudimentary thread,

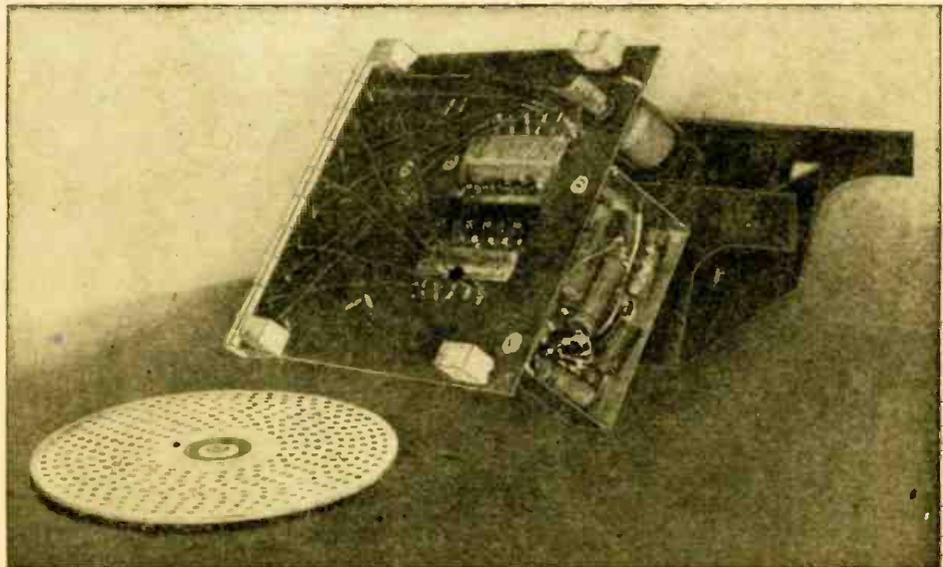

Fig. 3—Bottom view of the Fototone, with the tone disc shown in the left foreground.



the corners engaging in the threads of the flashlight lamps. Bend the strip of brass in the center along the dashed line. The unpunched half will go under the Masonite base, over the edge of the oblong hole to fasten the lamp holder in place.

The layout for the Masonite base is given in Fig. 6. Reference to Figs. 3 and 4 will show what each hole is for. No holes are shown for the motor, since this will depend on the particular motor used. Any motor whose speed can be varied by a series rheostat is satisfactory. Mounting holes for the chassis are likewise omitted. The lettered holes at bottom are for the 10 key contacts. These are brass rivets or screws, which should be put in place before the keyboard is attached.

Each key is made as in Fig. 7-a. The top is Masonite and the end is wood.

Cut, drill, and slot a piece of bronze weatherstripping, as shown in Fig. 8, to make the key contact strip. Mount it to the base with a 5/8 x 9-inch strip of Masonite to hold down its rear edge.

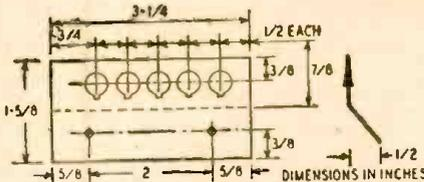

Fig. 5—Each holder takes 5 screw-base lamps.

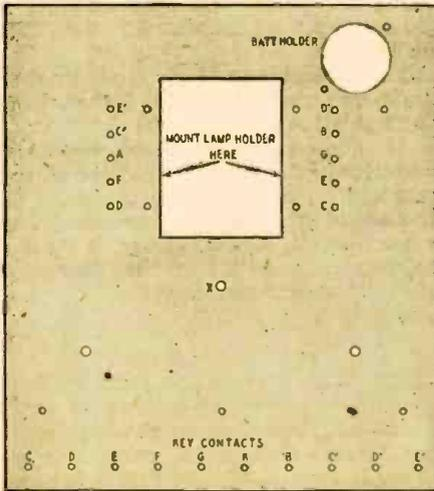

Fig. 6—The motor shaft projects through "X".

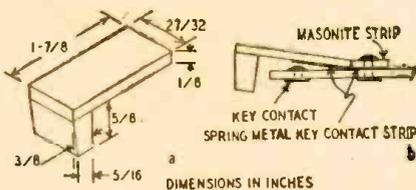

Fig. 7—Keys are constructed as in a and mounted on contact strips as shown at b.

This Masonite strip is shown in a side view in Fig. 7-b. Now bend up each of the 10 projecting strips so they do not touch the key contacts which are on the base. Using Duco or a similar cement, fasten a key to each strip. Refer to Fig. 7-b for the completed arrangement.

Figs. 3 and 4 show how the lamps are

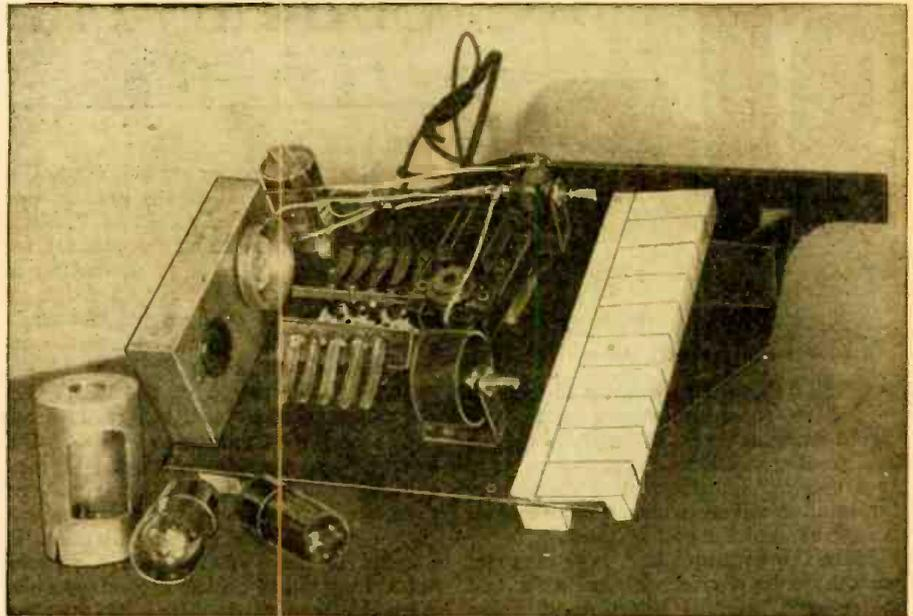

Fig. 4—Top view, showing lamp mountings. Inside of phototube shield should be blackened.

mounted in their two brackets. The brackets are a common contact for all the base shells, and strips of spring metal contact the tip of each lamp.

One side of the battery is connected to both brass lamp holders. The other side is wired to the bronze contact strip for the keys. Then each key contact (the rivet or screw mounted under the key on the Masonite base) is wired to the brass strip which contacts the corresponding lamp. Note from Fig. 6 that the lamps are staggered (C on the right, D at left, etc.). The letters indicate the notes for each key and lamp; correspondingly lettered studs and lamp contacts should be wired together. When the lowest key is pressed, the front right-hand lamp should light, and so on.

Now prepare the tone disc. Past experience has shown that this cannot successfully be duplicated from a magazine illustration; the authors will, therefore, supply discs at cost. See box on page 30.

Be very careful not to crease or bend the disc. Get an 8-inch aluminum-base instantaneous-recording disc ("acetate") and remove the black lacquer coating by immersing the disc in warm water for a while before peeling off the coating. The aluminum disc can be cut from sheet stock; but if this is done, the center hole must be very accurately placed.

Paste the photographic print of the tone disc on the aluminum, being extremely careful to match the center of the print to the center hole of the aluminum. Use Duco cement or something similar, but don't use too much. The finished disc *must be absolutely undistorted*, with no lumps, wrinkles, or other variations.

The motor shaft should project down through the Masonite base in the hole marked X in Fig. 6. Disassemble the motor and thread the end of the shaft, either on a lathe or with a die. After reassembling the motor and mounting it atop the base, fasten the disc to the shaft with a pair of nuts. Adjust the entire motor and disc mounting so that the disc will run true without wavering.

Each lamp is coated with black paint except for a small clear spot at the tip.

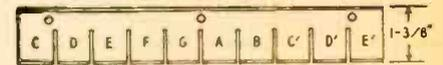

Fig. 8—Cement keys to contact strip.

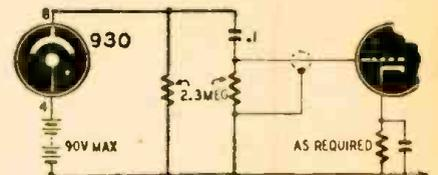

Fig. 9—Input circuit for phototube amplifier.

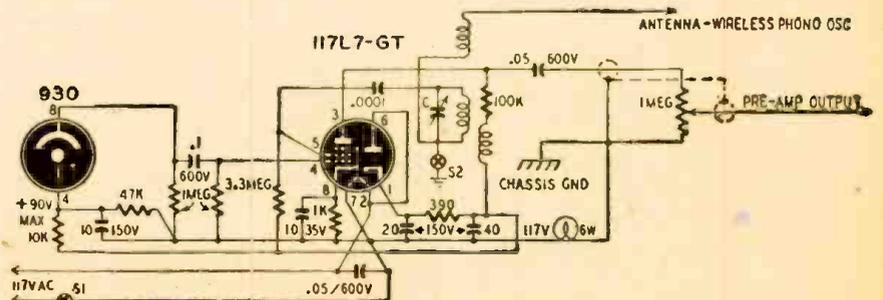
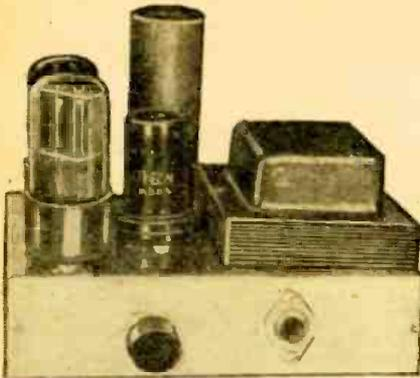

Fig. 10—A standard 3-winding phono oscillator coil is used. Bleeder supplies bias for 930.

# Simple Tracer - Amplifier

By HOMER L. DAVIDSON



Volume control projects through cabinet.

CONSTRUCTED primarily to test defective record changers and as a signal tracer, this small utility amplifier has greater possibilities. It can be used as a small PA system, as an amplifier for small receivers when greater output is desired, and for call systems.

Since the amplifier had to be compact enough to be carried around as a test instrument, careful selection of tubes and parts was necessary. It was constructed on a 4 x 6-inch chassis. The cabinet is 5 1/4 inches in height, 6 1/2 inches in width, and 4 1/2 inches deep. A small 650-volt, 50-ma power transformer with only two secondary windings was used.

Starting with the input (see dia-

gram), a .03- $\mu$ f paper capacitor couples the incoming signal to the grid of one of the triode units of a 6SN7-GT. Since this amplifier is used as a signal tracer, the blocking capacitor is needed when checking the audio signal in a defective receiver where B-voltages are present.

The amplified signal is resistance-capacitance-coupled to the grid of the second triode section of the 6SN7-GT. A half-megohm volume control is used.

The power output stage is a 6V6-GT beam-power amplifier with the screen-grid operating at a little lower voltage than the plate. An output transformer (8,000 ohms primary impedance) is coupled to the 6V6-GT with a switching arrangement on the secondary side. With this the built-in 4-inch PM speaker can be put in circuit when the unit is used as a signal tracer or small amplifier. For PA work or for testing record players, the secondary is switched to an external 8-inch speaker enclosed in a baffle. There is a phone jack at the rear of the amplifier for the latter.

Surprisingly good results are obtained

with the simple R-C power supply filter. Hum is negligible even with the larger speaker. Both sections of the filter capacitor and the 6V6-GT cathode bypass are in the same can, mounted next to the power transformer, as the chassis photo shows, to eliminate overcrowding.

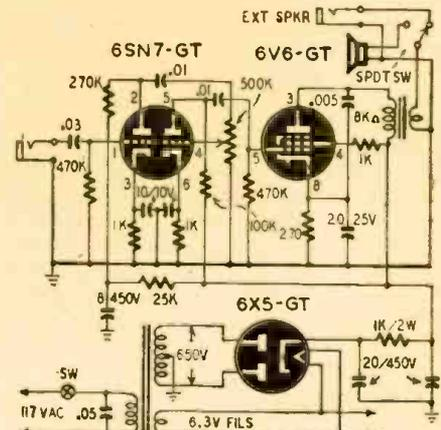

This circuit is simple and easy to build.

The chassis was made from a 7 x 10-inch sheet of aluminum. After corners were cut out and the necessary holes made, the sheet was bent to form a chassis top 6 x 4 inches with sides 1 1/2 inches high.

The cabinet was made from another aluminum sheet 16 x 17 1/2 inches, bent to form a bottomless cover.

The audio-tracing test lead consists of a shielded cable with a test prod at the end and an alligator clip connected to the shield for ground connection. The other lead, for signal tracing, is similar to that on page 50 of the February, 1948, issue of RADIO-CRAFT.

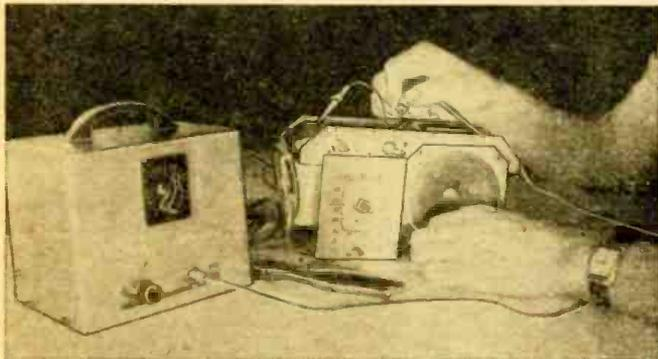

The author uses the amplifier to check a small receiver. The built-in speaker is in the top under the handle. Rows of 1/8-inch holes let sound come through. The switch in the center selects the built-in speaker or leads to the external speaker. It is a 2-position switch.

## ELECTRON MUSIC

(Continued from preceding page)

Adjust the position of each so that it illuminates only one circle of black spots on the disc. It should throw almost no light on any other ring.

That about completes the mechanical construction of the Fototone. It should be mentioned that when the chassis is made up, its most important mechanical detail is the placement of the phototube socket so that it will position the tube directly over the oblong hole through which the tone disc is visible. See Fig. 4.

The basic circuit for connecting the 930 phototube to the first tube of an amplifier appears in Fig. 9. If a PA amplifier is used, the microphone channel will be needed, since the phono input will not give sufficient gain. For connection to the a.f. system of a receiver or to a straight phono amplifier, a preamplifier will also be needed. If a special amplifier is built for the Fototone, it should have enough gain to give good results

with a crystal microphone. Good results may sometimes be obtained with lower-gain amplifiers, if the lamps are 2.2-volt types and two flashlight cells are used.

Fig. 10 is a combination preamplifier and wireless oscillator which may be used. With it, either photocell output can be picked up on a nearby broadcast receiver or the receiver's audio system can be connected directly. The oscillation can be stopped by opening S2. S1 is mounted on the preamplifier volume control. The 6-watt lamp is a safety device; if the preamplifier is connected to an a.c.-d.c. receiver and the lamp lights, reverse the a.c. plug of either the receiver or the Fototone.

After making up whichever variety of circuit is desired—oscillator-preamplifier or a complete amplifier—mount the chassis on its side at the rear of the Masonite base. The phototube shield shown in Fig. 4 may or may not be

necessary, depending on the hum present. It does no harm in either case because it also shields the tube from any unwanted light. Paint the inside of the shield black, using a flat paint.

The rheostat used to control motor speed in the original model was as shown in Fig. 2, but, depending on the motor used, it may be different. In the model, this rheostat allowed speed variations from about 50 to 1200 r.p.m., which was enough to give a range of five octaves, more than enough for any purpose.

The cover and music rack can be designed to the builder's taste. It need only be a box of Masonite with the right dimensions to allow it to be slipped over the completed instrument. Those who wish to duplicate the original model exactly will be able to use the blueprints which the authors send with the tone disc.

# Checking Performance of Phono Pickups

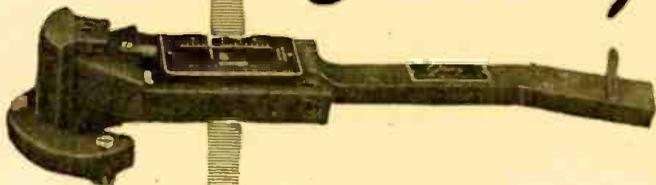

Courtesy Gray Research & Development Co.

By RICHARD H. DORF

FEW sound men can deny that for many years the reproduction of phonograph records has been a very haphazard affair. Following the usual procedure, the constructor walks out of his distributor's store with any one of the crystal pickups available for under ten dollars, connects its two leads to the phonograph input of his amplifier or receiver, and starts listening to records.

The results are generally far from ideal from the standpoints of frequency response, record wear, and distortion, among other things. In commercial home radio-phonograph combinations, the rea-

son for this lack of perfection is principally that each extra penny spent in production counts. In specially built equipment it is a lack of knowledge. In this article, we hope to supply much of that knowledge from a practical standpoint.

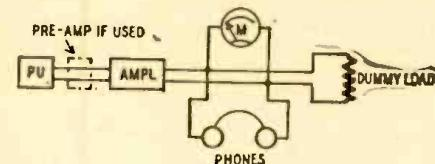

Fig. 1—Setup used in checking phono pickups.

First let us scotch the rumor that "phonograph records don't contain anything above about four or five thousand cycles anyway." The more recent records of the better manufacturers have a very usable response up to at least 8,000 cycles, and, in very many cases, records are good up to a full 10,000 cycles. The response is smooth within this range, and, with proper equalization of one of the modern pickups, performance approximating a live FM broadcast may be expected. Even surface noise will be almost unnoticeable.

The frequency response of records is not uniform throughout this range. This is not a fault, but, rather, a technical necessity.

During recording, stylus travel is greatest at the low frequencies. Volume at the low end of the range must, therefore, be reduced to prevent the stylus from cutting over into adjacent grooves. That makes some bass boost necessary in playback.

Most surface noise or scratch is in the high-frequency range. Record makers boost the highs during recording to get a favorable music/noise ratio. To restore the proper balance the highs must be reduced during playback. While restoring the musical balance, this reduction of highs brings the surface noise down, too.

The equipment necessary for measuring and adjusting a phonograph system includes:

1. Frequency test records. Several are available, but for purposes of discussion we shall use the Columbia 10003-M and 10004-M discs.
2. An output meter (a.c. voltmeter) of good frequency characteristics, preferably, but not necessarily, calibrated in decibels.
3. A supply of semilogarithmic graph paper, 3 cycles by 10 divisions.

The amplifier should be a good one with flat frequency response and low

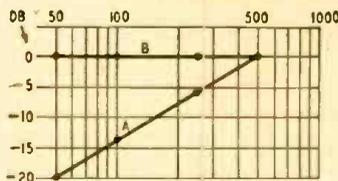

distortion. The pickup arm should be adjusted if possible to the recommended stylus pressure. No change should be made in stylus pressure after measurements are completed, since any change will alter the high-frequency response of the system. (Usually, the greater the pressure, the less the high response.) The loudspeaker should be replaced with a dummy load resistor equal to the out-

put impedance of the amplifier. Connect the output meter across the resistor. High-impedance headsets for listening to the test record may be connected across the resistor also. The setup is shown in Fig. 1.

## The low frequencies

In American-made recordings, the low-frequency band extends from about 50 cycles up to a turnover frequency of about 500 cycles. American records should be equalized with the Columbia 10004-M tone record, which has a 500-cycle turnover. In European discs, the low range ends at about 300 cycles. They should be equalized with the 10003-M, which has a 300-cycle turnover. Use of the American characteristic and the 10004-M disc is recommended, at least at first; the final complete equalizer can be made variable to accommodate both types of record.

Set the needle on the 500-cycle band. Adjust amplifier gain until the output meter gives a reading on some even division. Make a note of the reading. (We assume that the meter is calibrated only in volts.) This reading is now known as the *reference voltage*. It corresponds to zero decibels on the graph to be made.

Starting at the 500-cycle band, play the remainder of the record, the frequencies from 500 down to 50 cycles. As the meter comes to rest for each frequency, make a note of the reading. Then convert these voltage readings to decibels in the following manner:

If, for example, the reading for 250 cycles was 3 volts, and that for 500

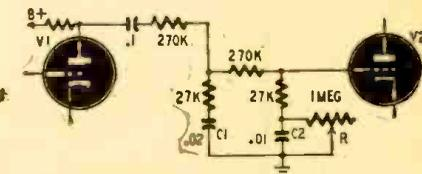

Fig. 4—Circuit for boosting the bass notes.

cycles (the reference voltage) was 6 volts, divide the larger number by the smaller. 6/3 equals 2. The 2 is the *voltage ratio* between the reference reading (at 500 cycles) and the 250-cycle reading. Find the number 2 under "Voltage Ratio" Fig. 2. Opposite it, in the decibel column, is the number 6. This indicates that the system output at 250

Voltage Ratio	Db	Voltage Ratio	Db	Voltage Ratio	Db	Voltage Ratio	Db
1.06	0.5	1.58	4.0	3.55	11	7.94	18
1.12	1.0	1.68	4.5	3.98	12	8.91	19
1.19	1.5	2.00	6	4.47	13	10.0	20
1.26	2.0	2.24	7	5.01	14	12.6	22
1.34	2.5	2.51	8	5.62	15	15.8	24
1.41	3.0	2.82	9	6.31	16	20.0	26
1.50	3.5	3.16	10	7.08	17	25.1	28

Fig. 2—The table of voltage-decibel ratios above is sufficient for pickup measurements,

cycles differed by 6 db from that at 500 cycles. It was, of course, lower, so place a dot at -6 db on the graph paper at the 250-cycle division, as in A of Fig. 3. The dot on the zero-db line at 500 cycles indicates the reference voltage, corresponding to zero decibels.

After determining the decibel equivalent for each of the frequencies, and placing corresponding dots on the graph, connect the dots with a pencil line. A in Fig. 3 shows the resultant curve from a perfect magnetic pickup through a perfect amplifier. Notice that the volume level decreases as the frequency gets lower. Bass boost will have to be used to bring up the lows.

The B curve of Fig. 3 shows output from the same record, using the same procedure but with a perfect crystal pickup. Because crystals have different characteristics from magnetics (they

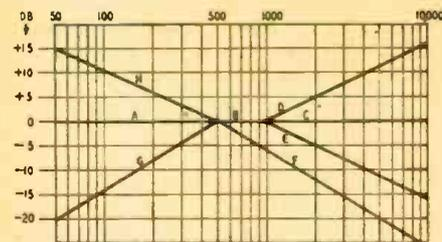

Fig. 5—Recording and compensating curves.

work exactly opposite), the bass will be reproduced properly, but the highs will need boosting.

No matter what type of pickup is used or how the original curves turn out, the object is to get flat output at the low end of the range. After equalization, a curve taken on the system should look like B (Fig. 3).

Output from most pickups will be very much like the curves shown, except that arm effects may be present. The arm in which the pickup is mounted is very important. Like any solid object, it has a mechanical resonant frequency which causes a large "hump" in the curve. Unfortunately, nothing can be done about it except to buy one of the better arms with a resonance frequency below audibility. If that is not possible, then equalization must be adjusted for a compromise.

The next step is to insert equalizer circuits to correct whatever deficiency is shown in the graph. For the magnetic-type pickup of A (Fig 3), for instance, bass boost must be used to counteract the drop shown. Fig. 4 shows a typical bass-boost equalizer. C1 and C2 determine the frequency at which the boost begins (the turnover frequency). The 270,000- and 27,000-ohm resistors control the approximate amount of boost. R is used for fine adjustment of the amount of boost. The circuit values shown will be about right to compensate for American records played with a good magnetic-type pickup. In effect this is a bass-boost equalizer, but it really does its job by reducing the middle and high frequencies. Inserting it in an amplifier will reduce the total gain of the amplifier considerably, and an extra stage will probably be necessary.

Often when using a crystal pickup nothing need be done about the low frequencies. If adjustment is needed, the load resistance into which the pickup works can be changed. Increasing this gives more bass; decreasing it reduces bass.

It is not possible to correct the middle range, except with very involved circuits, without also affecting the high range. Ideally, output in this range should be flat. Magnetic pickups may be flat, but crystal pickups will usually not be.

### The high frequencies

In making the graph for the range between about 1,000 and 10,000 cycles, the 500-cycle reference voltage should be retained to represent zero decibels.

A preliminary run of the 10004-M disc on a perfect magnetic pickup will show a practically flat output. However, to minimize noise, almost all commercial records are made with a boost or *pre-emphasis* in the high range.

No two manufacturers agree on the amount of pre-emphasis, and often two records from the same manufacturer will be different. A certain curve has been arrived at by engineers of the National Association of Broadcasters for use on broadcast transcriptions. Most good modern American phonograph records adhere more or less closely to this curve. Conformity to the NAB characteristic is neither universal nor

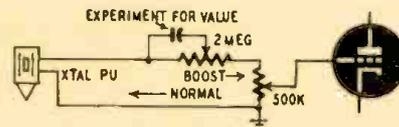

Fig. 6—Typical circuit for crystal pickups.

accurate, but as a compromise for adjusting a playback system, it is useful.

Curve GBD of Fig. 5 shows the NAB characteristic used in making recordings. (Notice that the low-frequency section corresponds to A in Fig. 3.) The records have a high-frequency pre-emphasis reaching +16 db at 10,000 cycles. The playback system must counter this rise with attenuation while boosting the bass at the same time. The entire playback equalization is shown in curve HBE.

The test record has the same bass drop G as standard records, so the actual bass response wanted from the system when using the test disc is curve A. But it should be clearly understood that the test record includes no treble boost. Therefore, the output from it after equalization should look like curve ABE.

When using a good magnetic pickup, equalization must be added to the circuit to reduce the high-frequency response to approximately that of curve E. A condenser across a grid resistor will reduce highs. Experiment with condenser values.

A crystal pickup initially showing a response like AF must be boosted to reach the desired curve E. Fig. 6 shows a suitable high-boost circuit for crystal pickups.

Many systems are good up to a certain frequency, but will not go as high as 10,000 cycles. With these systems, curve ABE should still be obtained as far as the system will go. Boosting intermediate frequencies to compensate for the lack of highs will result only in poorer sound.

High-frequency equalization should be either variable or (preferably) adjustable in steps by a rotary switch. Different amounts of equalization can then be used for records which do not sound right when played with the NAB curve. Some foreign-made records do not have as much high-frequency pre-emphasis as the American ones; a curve like AB in Fig. 7—not having so much de-emphasis—is useful for these. Very noisy records may require a sacrifice of fidelity for the sake of quietness. Additional de-emphasis, for instance that of curve AC, can be used. Another help with very bad discs is a cutoff at around 5,000 cycles, as shown in ADF. (The response of most inexpensive crystal pickups cuts off between 4,000 and 8,000 cycles, anyway).

So far we have been using the Columbia 10004-M test record to equalize for American recordings. It is a good idea to provide for European records too. To do this, simply use the Columbia 10003-M disc and re-equalize the low range for flat output. The equalization used should be included on a switch position, so that it can be cut in when necessary. Rather than adding a complete separate equalizer for European records, it is easier to use the same equalizer used for American records and simply to vary the single component—usually just a resistor—which regulates the amount of bass boost, without changing the frequency at which the boost starts. R is used for this purpose in Fig.

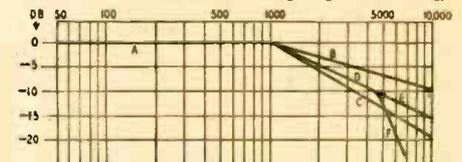

Fig. 7—Special-purpose compensation curves.

4. The result will not be quite as accurate as with the more complicated method, but it will relieve the excessive boominess heard when European records are played on an American system. To save the investment in an additional test record, the adjustment can be made by ear while playing European records.

The equalizer diagrammed in Fig. 4 can be used at almost any point within an amplifier. However, depending on the output of the pickup used, it may be necessary to add extra amplification to offset the loss (about 40 db) in the equalizer. If that is the case, V1 and V2 may be the two sections of a 6SC7, with the tube being used as a preamplifier ahead of the main amplifier.

Other equalizer circuits will be found in RADIO-CRAFT. Any one of these, if it has the proper frequency characteristic, can be used to correct the pickup response.

# Church Bell Records

New method of engraving sound tracks in steel makes records of great durability

A NEW method of recording and reproducing the sound of church bells has been devised by G. Chancenotte, a French inventor. The recordings consist of engraved sound tracks on tapes or cylinders of magnetic material; the sounds are reproduced magnetically. The special virtue claimed by the inventor is the durability of the recordings.

The sound is recorded first on a strip of motion picture film, using the variable-area method. When the film is developed, the sound track looks like Fig. 1. Several of the tracks are recorded

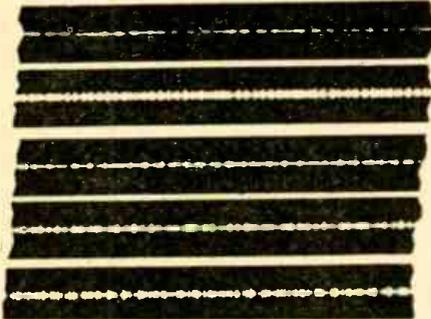

Fig. 1—Several typical sound-track specimens.

side by side on one strip of film. The film is then used to make a photoengraving on a steel tape or cylinder.

A section of the track engraved on the steel is shown in Fig. 2. Whether the tape or the cylinder is used, the ends of the track are joined to create an endless-belt effect. Therefore the bell sounds may be played for as long a period as desired.

The reproducing head is made of a piece of mu-metal bent into the shape of a square U. One arm has a beveled end; on this arm a low-impedance winding is placed. A permanent magnet is placed

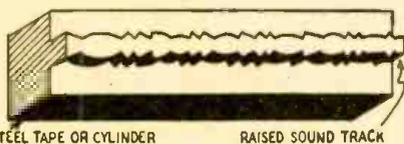

Fig. 2—How the track is engraved in steel.

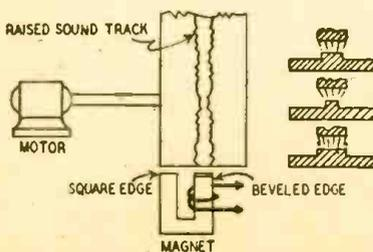

Fig. 3—Detail of the track and pickup system.

on the other arm. As Fig. 3 shows, the head is placed so that the magnetic flux passing from the magnet to the winding must pass through the sound track. As the track moves, the varying width of the raised track varies the permeability of the steel path at an audio rate. The flux reaching the coil therefore varies, and the induced coil current is amplified and fed through speakers to produce the sound.

The playback head does not actually touch the sound track, so there is no problem of wear. Demagnetization of the sound track is not a factor, because the track is not magnetized in the first place.

Several sound tracks and playback heads are placed on each of two cylinders in the unit used in churches. Each track contains one of the desired bell sounds and cylinder rotation speed can be varied to produce still other tones. Speeds for the cylinders are normally 30 r.p.m. for the one containing the higher-pitched sounds and 20 r.p.m. for the other, which contains the bass bells. Each cylinder is about 3 feet in diameter.

A complex system of relays and cams has been devised by the inventor to play certain selections automatically and to produce various effects by mingling sounds from the two cylinders and vary-

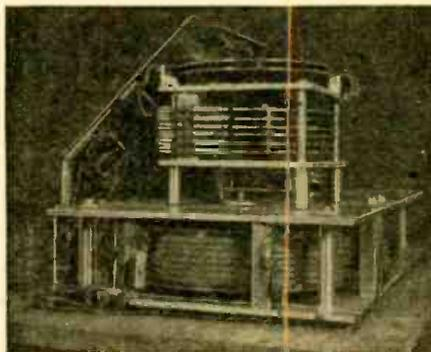

Fig. 4—A complete set of relays and tracks.

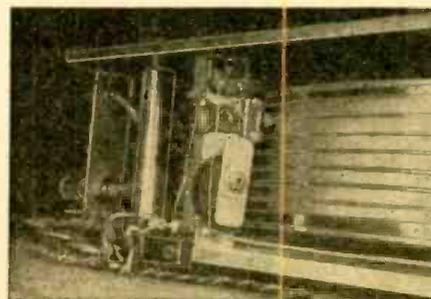

Fig. 5—A closeup of sound tracks and pickup.



Fig. 6—Setting the bells for desired time.

ing the speed of each. The cams and one of the cylinders appear in Fig. 4. Note the six sound tracks on the cylinder (bottom of picture).

Fig. 5 is a closeup of the playback head used for the topmost track. The other photograph shows the control panel of the electronic bell system. The clock is set to start the bells automatically at certain times and the other controls provide for ringing them "manually" or setting up the various possible special effects.

## LOUDSPEAKER RECEPTION

It is difficult to attach a loudspeaker directly to the outputs of surplus SCR-274-N command set receivers because the impedance is incorrect and the level too low. The circuit shown illustrates a method of obtaining the advantages of speaker reception and increasing selectivity and gain.

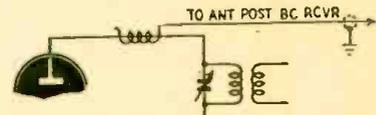

LAST IF SCR-274-N RCVR

An insulated wire is wrapped around the lead which connects the plate of the final i.f. stage in the receiver to the i.f. transformer. The wire is connected to the antenna terminal of an ordinary broadcast set. Since the i.f. of the 3-6-mc receiver is 1415 kc, the broadcast set, when tuned to that frequency, will pick up the signal from the surplus receiver, convert, amplify, and detect it, and feed it through the loudspeaker. The two receivers become one double superheterodyne.

If the broadcast set is an all-wave type, the 40-meter receiver from the SCR-274-N may be used in the same manner. Its i.f. is 2830 kc.

FRANK BODINE, W4JVZ,  
Fort Wayne, Ind.

# THE HI-FI EXPERT TRACKS DOWN HUM



The author communes with his soul, but the hum buzzes merrily on.

**T**HE worst case of hum I ever saw or heard was one of my own. Naturally. Nobody else I know uses such screwy circuits or makes such dumb mistakes. Whenever I use standard circuits, I get satisfactory—if uninteresting—results; but when I improve on circuits—brother, that's a humdinger!

The time I'm thinking of wasn't that deal with the preamplifier on one of the XYL's ice trays. ("We Learn the Hard Way," *RADIO-CRAFT*, Jan., 1944.) This one involved a simple tuner-and-amplifier combination.

I had built the amplifier first and it sounded pretty good—a pair of 2A3's in class A1 with fixed bias—so I threw together this simple little t.r.f. tuner, just one r.f. amplifier feeding an infinite-impedance detector. I lined it up strictly by ear, and it sounded pretty nice over the headphones. So I hitched it up to the amplifier.

Man! That thing had a terrific hum level. The XYL cocked an eyebrow. "What, again?" That ice-tray deal still rankled a little.

I coughed delicately. "Must have popped a filter." I disconnected things and pulled off the bottom plate of the amplifier. Then I realized that rasp was no filter—I must have mucked up the ground circuit; so I put it back and connected it right, ground side to chassis, hot side to grid, and flipped the switch on.

The hum was still there, so I flipped the switch off again without looking in the XYL's direction. This time I took

down the amplifier and started prodding around among the filter condensers. They all seemed to be O.K., so I turned off the amplifier and connected the tuner directly to the speaker.

The program came through—faint, but clear of hum—so I tied the amplifier to the speaker instead and cranked the gain way down to avoid offending the XYL's ears. No hum. Upped the gain a bit, then more, and then all the way. Very, very slight hum at full gain with a lot of tube hiss mixed in.

"Hmm. Intermittent?" I banged individual condensers, popped light switches, and finally started tapping a screw driver against the amplifier itself.

"Here, try this." But I scorned the hammer the XYL held out to me.

"You don't hear any hum now, do you?" I demanded, turning the gain wide open.

She shook her head. "It was probably my imagination before. You know me."

I didn't trust it, but I hitched it all up again the way it had been and then turned the switch on.

That hum was terrific, but instead of switching it off right away I went through my routine of tapping and banging at the tubes and filter cans.

"On second thought," the XYL shouted at me, "maybe I do hear a little hum at that."

I put one hand to my ear. "How's that?" I shouted back.

I flipped the switch as she repeated it and her last words echoed all around the whole neighborhood.

Hum is one of the trickiest troubles known to the sound engineer. Mr. Langham relates a hum-filled adventure with a tuner-amplifier.

By JAMES R. LANGHAM

I raised my eyebrows. "There's no occasion," I said stiffly, "for you to raise your voice like that to me." Then I dodged and she missed.

I turned it all on again and started in earnest. I cranked the gain down, and the hum went down too. It was about 2 or 3 db less than the program level. I paralleled each condenser with a known-to-be-good one. No change. I listened with phones at practically every spot on that chassis. The B-plus was clear and free all along the line, and so was the fixed-bias line. My grounds were all fine and bright. Everywhere there was a signal there was also that hum. Right back to the input.

Aha! I switched off the tuner—the hum and signal died together. "Barking up the wrong tree, hunh?" The XYL spoke from behind my shoulder.

I nodded and put the amplifier back together and then back on the shelf and pulled the little tuner down in front of me. I opened it up, and it was so simple that I couldn't see where there could be any trouble in it. Heck, it didn't even have a.v.c.

I prodded around inside with headphones. No hum there at all. I had the XYL listen. Then I tied it into the amplifier and turned it on and, HMMmmm, there it was again. I tracked it up to the detector itself, and filters didn't help at all.

I turned off the whole shebang and sulked. It didn't make sense to me. Either one alone was free of hum, but together they hummed.

"Maybe it's the broadcasting station," the XYL suggested.

I shook my head. "It was KFI. They wouldn't have anything like that." I pulled down Terman and began studying. Then I pulled down Reich. Then Henney. Then the Hambook.

After awhile I turned it all on again.

I turned the plugs in the wall socket. I put little condensers across the line as filters. Nothing did any good.

Could it be some appliance in the house? I wondered. I began turning lamps and stuff on and off. Then I turned the volume up so I could hear while I went out to fiddle with the fuses in the kitchen. Out there I heard both signal and hum go off and come back and go off again.

### Hum on carriers only

I raced into the room to find the XYL twisting the tuning condenser. "Look," she said. "I think it is the station at that."

Tuning off the station killed hum as well as signal and left silence.

Then she turned to another station and there was the hum again. All over that dial there was hum wherever there was a signal, but no hum in between. "Are they all humming?"

"No, we're modulating the carrier ourselves some way." I knew that much.

I went back to the books again and studied. After a while I ripped out the filament wiring in the little tuner and rewired it with 2-conductor shielded cable. No change. Then I got drastic and heated the tubes in the tuner with 6 volts of flashlight battery.

Still that hum. So I got discouraged and we listened to Jack Benny on the other little radio and then went to bed.

I don't know now how long I played around with that outfit before I got on to the deal, but I do remember listening to a musical program on the little radio and turning on the big amplifier to play some of our records afterward. As the amplifier warmed up, here came that same hum out of the little radio. Terrific hum.

I turned off the amplifier and the hum died. Turned it on again and there it was. Well, instead of playing records that night, I fooled around the inside of that amplifier with every trick I knew or ever heard of. I hooked in potentiometers to the transformer windings that were supposed to be center-tapped to ground and grounded the pots so I could move my ground from side to side to compensate for any unbalance in the transformers. I raised the level of my filament string from zero to as high as 20 volts. I paralleled all the electrolytics with paper condensers. I did everything I could think of, humming all the while.

After I had tried all the things I could possibly imagine any reason for, I began doing things without knowing why I was doing them or how they could possibly help. The same idea as beating a tin pan to chase the devils away, I guess.

I was fooling around with a small paper condenser when the hum suddenly stopped. I stopped daydreaming and looked. What I had done was tie this small condenser from plate to filament of the 5Y3-GT rectifier of the bias supply. It killed it. No hum. I took it off, and there was hum.

I couldn't figure out just what I was

doing and why it should stop hum but I wired the condenser in. Then it popped itself out—began smoking—so I replaced it with a regular buffer condenser. Higher voltage. (See Fig. 1.)

You see, I still believed in class A1 then, and I liked the fixed bias so I had a separate bias supply for the 2A3's. Well, not wanting to have that fail and leave B-plus on my plates and so burn up my tubes and output transformer, I had installed a relay. I used the relay coil as a filter choke for the bias supply

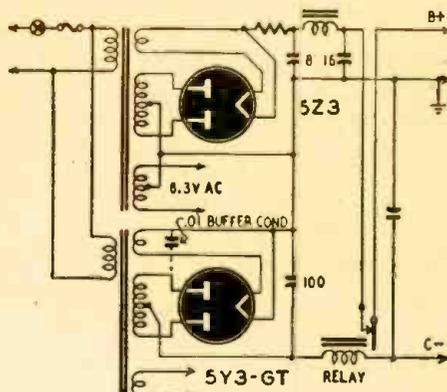

Fig. 1—The buffer condenser cured the hum.

and had some whacking big condensers (low-voltage ones) as filters along with it. That must have been the trouble. I had some very funny reactances there, and it was putting out a peculiar field that would modulate any neighboring r.f. Putting that buffer condenser across it upset those reactances and resonances, and killed the deal.

The XYL heard the outfit playing and came in to see how I'd fixed it. I couldn't tell her how or why it worked, but I showed her that it did. She asked so many questions, though, that I blamed it all on the guard-relay circuit and redesigned it, as shown in Fig. 2.

I used a different switching circuit and arranged to flip the tubes over to self-bias when the fixed bias failed. I told her that was better and showed her

how and why. I snowed her under with words and until she reads this she hasn't known that I didn't know what I was doing then.

Since then I have run into the same modulated-hum trouble in other outfits. On three occasions I cured it the same way—right first try out of the box—and the owners thought I was a fine engineer to have diagnosed the trouble so easily. On the other occasion an a.c. line really was causing the hum. We found that out by unscrewing fuses from the household box.

As for unmodulated hum, the ordinary kind, it's usually caused by insufficient filtering. Obviously. When it's a high gain job, I always suspect the ground circuit. Ground loops can do strange things. I like to run my ground as a lead and tie it to chassis at just one spot. I generally pick that spot experimentally, sometimes near the power tube and sometimes near the lowest level. Theoretically it should be either at the point of highest current or lowest level. I am never sure which, and I'm not sure there is an arbitrary standard. I've seen amplifiers built with over 100-db gain and with all grounds made to chassis at the handiest points. Some of them have been quiet and a lot have been terrible.

### Sound engineer's credo

I believe all shielding should be grounded at one end—not both—and grounded to chassis. I believe the No. 1 pins on tubes should be tied to chassis. I believe signal grounds should be kept separate from chassis grounds and B-minus except at one point. That point should be either at the output tube or the input tube.

I also like to parallel electrolytics with small paper condensers, but that's more to prevent oscillatory trouble than hum.

One case I remember was a PA system where the preamplifier tube hummed terribly. The trouble was ground loops. We didn't have time to

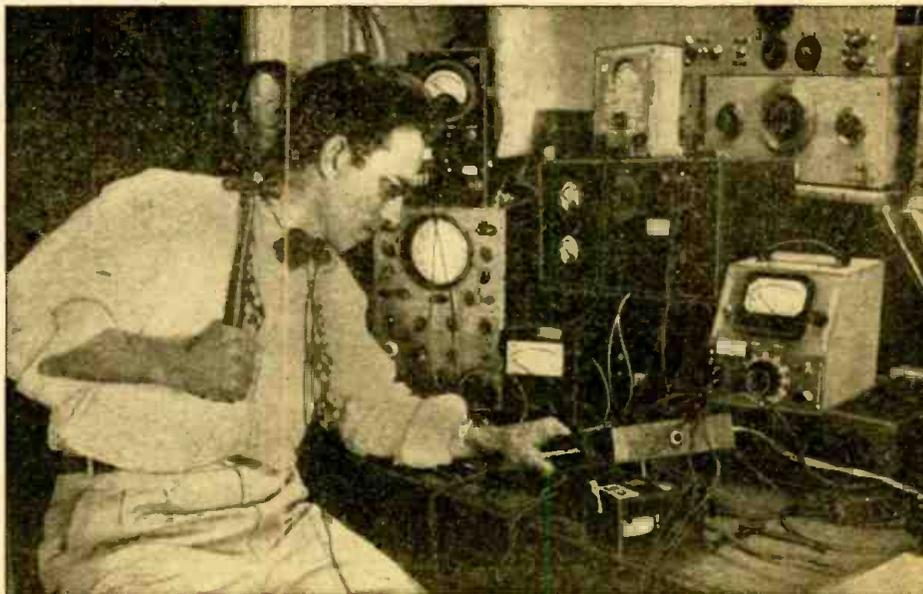

A smart hammer blow is one way to stop hum but the author does not recommend it—very often.

rewire the whole outfit, it was one of those deals where the wiring is laced and then varnished. Lovely to look at, but oh, that hum! It had to be used that afternoon. It had a 6SJ7 input, and the final was a pair of 6L6's. I pulled

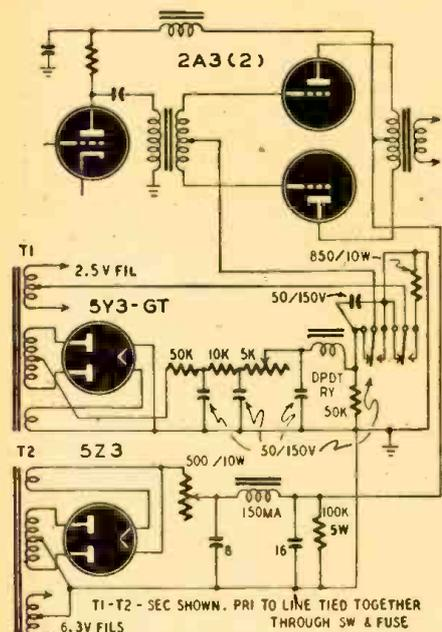

Fig. 2—This is the redesigned guard circuit.

out the 6SJ7 and substituted a 12SJ7 and then ran a d.c. filament by wiring it in series with the B-minus. The circuit appears in Fig. 3. The total drain was close to 150 ma, which just lit the 12SJ7 nicely. The 6L6's didn't seem to miss the lost 12 volts from their plate voltage, and the hum was way, way down. Later the owner rewired the amplifier with more attention to ground loops and cleared up the situation. You could argue that the trouble there was filament induction rather than ground loops, and you might be right. I do know, however, that it was cured by (1) d.c. filaments, (2) rewiring the ground.

All the high-gain amplifiers I have fooled with since 1939 have had potentiometers across their filament supplies with the center arm grounded. If they didn't have them when I got them, they had them when they left me, because I've run into a lot of transformers whose centertaps haven't been in the center, electrically speaking. That little trick with a potentiometer—100 ohms or so,

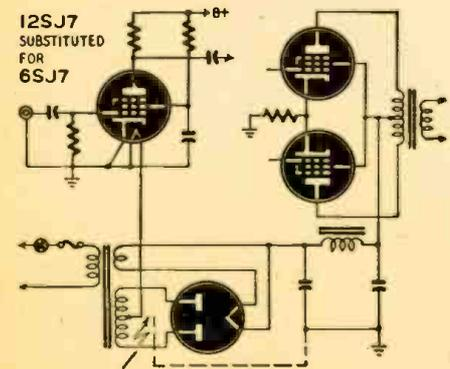

Fig. 3—A change of tubes stopped hum here.

it's not critical—will give at least a 5- to 7-db hum reduction on the average outfit and considerably more on some.

I've often heard of curing hum troubles by raising the whole filament supply several volts above ground, but I've never succeeded with one of those cases myself. I've tried it—oh a dozen times—on hummy amplifiers, and not once have I seen it work. It might help on the millions I never tried, but I can't confirm that.

The best solutions are (1) watch your layout; (2) watch the grounds—separate grounds for chassis, signal, and B-minus; (3) use metal tubes or tube shields in low-level stages; (4) use a 100-ohm potentiometer across the filaments and ground the center tap; (5) use a hot iron. This last is most im-

portant. It's amazing how many otherwise smart radio men will keep their irons too cool. Cold joints are nasty things.

Also important is to tighten potentiometer nuts and use star washers under them. I lost a star washer when I was putting together our present unit so I left it out. Presently the set hummed from time to time. The XYL humbled me by stopping it—she put a book on top of the knob. The pressure made the contact good enough to cure the hum. It was one of those silly things I should have known better about. Finally, of course, I got a star washer and put it in, but the XYL still brings it up in conversation with other radio men; and I daresay she'll remember and tell about it when I'm 83.

## HEARING AID HAS PICKUP COIL

A NEWLY developed hearing aid uses a magnetic microphone, which is unaffected by temperature and humidity, in place of the more common crystal type. Another important feature of the unit is an inductive pickup coil (Fig. 1) for use when telephoning which is built into the front of the plastic case. In use, the telephone receiver is held near the front of the case, and the amplifier input is switched from the microphone to the pickup coil.

Inductive coupling through the magnetic field of the telephone induces a voltage in the pickup coil.

While the crystal microphones in hearing aids do give good results, their efficiency is reduced at the operating temperatures normally encountered (90 degrees F), and they may be ruined in time by either humidity or dryness.

The magnetic microphone used in this hearing aid is made almost entirely of metal. It consists of a thin aluminum diaphragm cemented to the edge of an aluminum case (Fig. 2). An aluminum-alloy driving pin soldered to the center of the diaphragm transmits vibrations to a smaller diaphragm and armature made of nickel-iron. As the armature vibrates, it induces a voltage in the bipolar magnet coils spaced beneath it.

A resonance tube connects the air behind the aluminum diaphragm with the outside to give a considerable increase in low-frequency response. Closing the

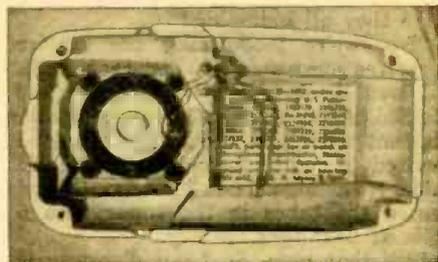

Courtesy E. A. Meyers & Son

Fig. 1—Inductive pickup coil is in case front.

tube with a small screw results in a reduction in low-frequency amplification.

The hearing aid amplifier has three stages, with an over-all voltage gain from the first grid to the last plate of about 20,000. Tubes are of the subminiature type: two CK512AX voltage amplifiers and either a CK522AX or a CK507AX as output tube. The microphone and pickup coil are transformer-coupled to the input, and the output is transformer-coupled to the air- or bone-conduction receiver. Self-bias on the output tube results in stable performance.

The frequency range of the hearing aid is deliberately limited to approximately 300 to 3,500 cycles to minimize the effects of noise and nonlinear distortion. A noise control reduces amplification on frequencies below 1,000 cycles and above 2,000 cycles.

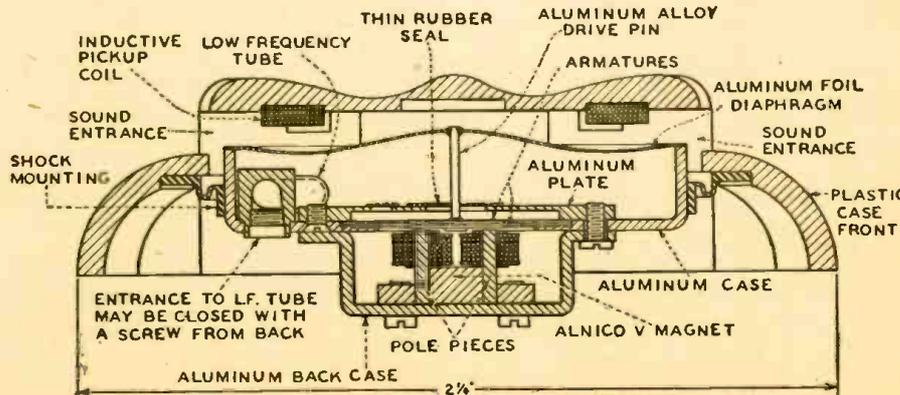
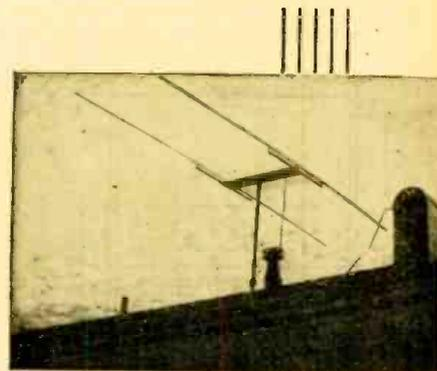

Fig. 2—Cross-section of microphone, showing inductive pickup and the resonance chambers.



# A Folded Dipole 10-Meter Antenna

By A. B. KAUFMAN



Directional dipole in its place on the roof.

THE folded dipole has become very popular for FM and television antennas and, recently, for use on even the lower-frequency bands by amateurs. Usually, the antenna is made of 300-ohm ribbon line.

This 10-meter beam uses the folded dipole, but adds a reflector to it. The front-to-back signal ratio is 10 to 15 db, and the gain is about 5 db over a single half-wave antenna. The beam is rotated by a surplus gun mount. Construction is less difficult than for the usual rotatable beam.

A two-element beam was chosen for several reasons. First, it will work efficiently over a much broader band of frequencies than will an antenna of three or more elements. It is certainly easier to build, and the supports and rotating motor have less of a load to carry.

A reflector was used as the parasitic element rather than a director because its spacing is much less critical. A reflector can be spaced farther from the radiating element than a director, and yet give the same gain without cutting down radiation resistance so much.

A folded dipole was used as the driven element because of its high radiation resistance and its broad tuning. The reflector brings this resistance (normally 300 ohms) down to between 60 and 150 ohms. A 70-ohm line can be used to feed the antenna, though even 300-ohm twin lead will work satisfactorily.

The folded dipole and the reflector are made of dural or brass tubing to the dimensions given in Fig. 1. The driven element is made in three pieces, one 16 feet long and the other two about 7 feet 11 inches each. Tubing clips are used at the ends of the assembly to hold the rods together and to short them electrically. It is not a good idea to drill the tubing, since this weakens it. The reflector is 16½ feet long.

Additional tubing clips are used to hold the folded dipole rods together near the center. At this point, however, the rods must not be shorted to each other, so a tight-fitting piece of fiber tube is placed over each rod and the clip clamped over the fiber.

The element support is made of knot-free wood which is not likely to split. As Fig. 2 indicates, the main support is a piece of ¾-inch-thick wood 4 x 10 inches. Attached crosswise to each end is a 4-foot length of 1 x 1. It is to these crosspieces that the elements will be mounted.

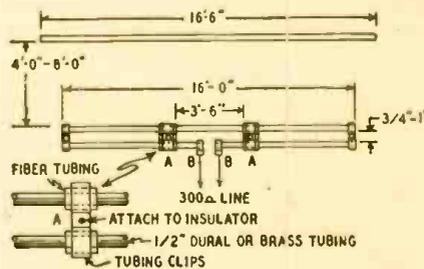

Fig. 1—Dimensions of the radiating element.

Five stand-off insulators are used for mounting the folded dipole: one at each of the fastenings A (Fig 1), one at each point B, and one at the center of the unbroken dipole rod. The insulators are attached to the A points as shown in the detail drawing of Fig. 1, and the others are fastened to the rods directly with tube clips. The insulators are then screwed to one of the wooden crosspieces.

The reflector rod is fastened to the other crosspiece with tubing clips and insulators in the same manner. Three insulators are sufficient.

The vertical pole supporting the beam is made of dural, brass, or thin-wall steel tubing about 2 inches in diameter. Do not use water pipe, it being too heavy and not sufficiently rigid. A flange welded to the top of the pole holds the wooden beam support.

Fig. 3 shows how the beam is mounted. The rotating mechanism (details later) is on the floor of the attic. The pole goes through a hole in the side of the sloping roof. At this point, a short length of pipe is used as a bearing. Its inside diameter should be enough larger than the outside diameter of the pole to allow the pole to turn freely, but not so much larger that there is excessive play.

The bearing pipe is attached to the roof by a flange. Since the roof slopes,

the flange must be welded to the bearing pipe at the proper angle to make the pipe exactly vertical. To determine this angle, use a protractor and a liquid level, the kind employed by carpenters. Fig. 3 shows how the protractor is held on the roof. The level is adjusted to center the air bubble, and the roof-slope angle is read from the protractor scale. Be sure the flange is welded to the bearing pipe at exactly this angle.

The flange itself need not be round, but it should be large enough so that it can be screwed to two of the shingle support boards. To make the assembly rigid put long machine screws right through the shingle support boards and the flange and tighten nuts on the ends, using big washers under the nuts.

To prevent water from dripping down the antenna pole and through the hole in the roof, cut one end off a large tin can, and then in the other end cut a hole equal in diameter to the antenna pole. Slip the can over the pole with the open end down, so that the open end is over the upper end of the bearing pipe. Calk and tar the hole in the other end so that the can will stay in position on the pole and no water will get through the hole. To keep the can in place it may be necessary to use setscrews as indicated in Fig. 3.

The distance between the attic floor—the lower support for the pole—and the bearing pipe determines how high the antenna pole can be. The leverage should be not greater than 4 to 1. That means that with a floor-to-roof height of 5 feet, for example, the pole should be not more than 20 feet above the roof, giving a maximum total pole length of 25 feet. This is a rather dangerous maximum, however, and preferably the pole should be much shorter. At W6YOV

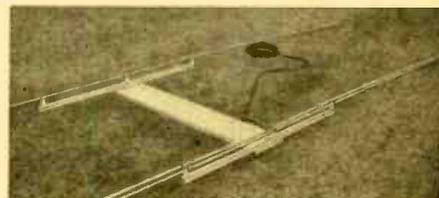

This closeup shows rotating element clearly.

the pole extends 8 feet above the roof. A surplus K7 gun mount, sold by many radio stores for just this purpose, supports the bottom of the pole and at

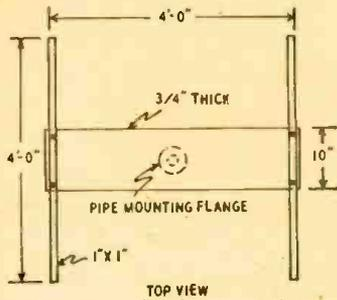
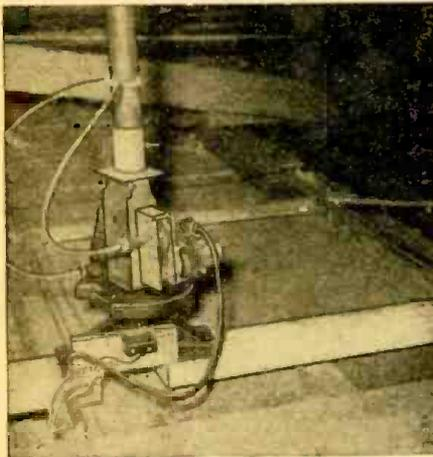

Fig. 2—Some details of the rotating member. the same time provides a means of rotating it. Remove all excess parts and gearing, and bolt the gun mount securely, base down, to the attic floor. To its top secure a piece of tubing just large enough to receive the base of the antenna pole. A single 8-32 bolt passed through this tubing and the pole base will hold them together.

Mount a small motor (some 24-volt d.c. surplus motors can be operated intermittently from the 117-volt a.c. line) on the rotating framework and attach the flexible drive cable from the gun mount to the motor shaft.

If the antenna is allowed to rotate continuously more than 360 degrees, the leads to the motor (which rotates with the gun mount) and to the antenna will eventually be pulled out by the roots. Slip-ring arrangements are possible, but a good deal of trouble. It is better to limit total rotation to about 330 degrees



The K7 gun mount which rotates the antenna.

and make the motor reversible. Orient the antenna so the dead spot is in the least useful direction.

The limiting is done with microswitches mounted in a small box or attached to some part of the gun mount support. A small piece of metal or wood should be adjusted to ride over one of the switches at each end of the rotation swing. Be sure to arrange matters so that, if the antenna coasts after the power is off, the microswitches will not be ruined!

Two wiring diagrams for the rotating motor are shown in Fig. 4. In Fig. 4-a

the motor has two leads for the armature and two for the field. A 6-wire cable is run from the attic to the operating desk. A d.p.d.t. switch controls the direction of rotation, and a push-button operates the motor. The microswitches are normally closed units. If the motor does not go off when a microswitch opens, reverse the field connections.

If the motor has a center-tapped field, only three wires and a s.p.d.t. switch will be necessary, as shown in Fig. 4-b. If the microswitches do not operate properly, reverse field connections.

If the motor used is a 24-volt d.c. unit, a line-dropping resistor or a tungsten lamp will have to be placed in series with the 117-volt a.c. line. These motors will overheat on continuous duty. Probably a 117-volt a.c. motor would be best, though perhaps a little more expensive.

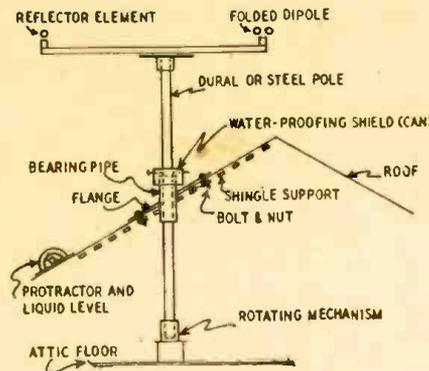

Fig. 3—How the mast goes through the roof.

The motor should be geared down so that the antenna does not rotate faster than about 1-4 r.p.m. This holds true, whether the K7 gun mount or any other worm-gear-and-pinion arrangement is used. It may be necessary to bypass the motor with a 0.1- to 1- $\mu$ f capacitor to eliminate noise pickup in the receiver.

There is no reason why this antenna could not be used on higher-frequency bands.

The dimensions given for the lengths of the elements were figured roughly for the high end of the 10-meter band. For any other frequency on any other band, use the following formulas: For the folded dipole, the length in feet from end to end equals  $955/\text{frequency in mc}$ . Length in feet of the reflector equals  $492/\text{frequency in mc}$ . Spacing between elements should be between one and two tenths wave length, but this is not too

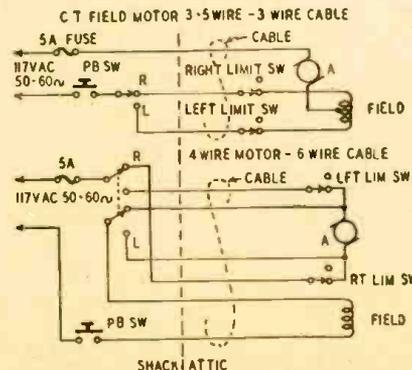

Fig. 4-a, below—Motor connections; b, above—connections for a center-tapped motor field.

critical. Minimum spacing will give the best match for a 70-ohm transmission line; maximum will be best if 300-ohm ribbon is to be used.

### SURPLUS CONVERSIONS

By MILTON KALASHIAN

Many articles have been published in the past couple of years on conversion of surplus equipment for ham use. This index of these articles enables the owner of a piece of surplus gear to find all the available information quickly.

Symbols used are RC (Radio-Craft), RN (Radio News) and RH (Radio Handbook, 11th edition, Editors and Engineers, Santa Barbara, Calif.)

150-B Transmitter.....	QST Sep 47 p. 22
Improving c.w. operation of.....	QST May 48 p. 69
APS-13, 420-mc operation of.....	QST May 48 p. 57
ARC-5 (see SCR-274)	
ART-13 Transmitter.....	RN Dec 46 p. 50
	CQ Feb 47 p. 33, Nov. 46 p. 13
Speech amplifier.....	RH p. 437, CQ Dec 47 p. 19
8C-191 as modulator.....	QST May 48 p. 436
BC-221 Frequency Meter	
as c.w. monitor.....	RN Apr 48 p. 160
Modulation of.....	QST May 48 p. 68
Power supplies for.....	QST May 47 p. 72
	CQ Apr 47 p. 30, Jan 48 p. 28
as v.f.o.....	RH p. 445, QST Mar 47 p. 43
BC-312 Receiver	
A.c. power supply for.....	RC Jan 48 p. 74
Conversion.....	RH p. 431
BC-342 Receiver, conversion.....	QST Sep 46 p. 42
BC-348 Receiver	
Conversion.....	QST Jan 47 p. 19, Nov 47 p. 66, CQ Apr 48 p. 25, RH p. 435
Dial backlash elimination.....	QST Feb 48 p. 59
5-meter for.....	RN Apr 48 p. 68
BC-375 Transmitter	
Conversion.....	QST Dec 46 p. 38
as Modulator.....	RH p. 436
BC-406 Receiver.....	CQ Feb 46 p. 18
BC-412 Oscilloscope.....	RC July 46 p. 70
	Oct. 46 p. 18
as Television receiver.....	RN Aug 47 p. 45
BC-453, 454, 455, 457, 458, 459	
(see SCR-274)	
BC-610 Transmitter (see SCR-299)	
BC-624, 625 (see SCR-522)	
BC-645 Transmitter-Receiver, 420-	
mc operation.....	QST Feb. 47 p. 15
BC-652, 653 (see SCR-506)	
BC-654 (see SCR-284)	
BC-696 (see SCR-274)	
BC-746 Tuning Unit as pocket c.w.	
transmitter.....	QST Jan 48 p. 62
BC-779-A Receiver, improving sta-	
bility.....	CQ May 48 p. 32
BC-946 Receiver, conversion.....	RC Feb 48 p. 26
BC-1068-A Receiver	
2-meter operation.....	CQ Jun 47 p. 25, RH p. 442
as Television receiver.....	RC Jan 48 p. 57
BC-1284 Preselector.....	CQ Mar 47 p. 32
CAY 47150 Tuning Unit as carrier-	
current transmitter.....	RC Oct. 47 p. 24
CW-3, F-3 Receivers, FM and NFM	
conversion.....	QST Apr 48 p. 48
LM Frequency Meter	
Modulation of.....	QST May 48 p. 68
Power supply for.....	RH p. 445
as v.f.o.....	QST Aug 46 p. 34
PE-110 Power Supply, conversion.....	RH p. 441
Propellor pitch changer as beam	
rotator.....	CQ Apr 48 p. 38
SCR-211 (see BC-221)	
SCR 274	
Receivers.....	CQ Nov 47 p. 24, RC Feb 48 p. 26
BC-453 as Q-Ser.....	QST Jan 48 p. 40
Connections.....	RC Mar 48 p. 44
Transmitters	
BC-459, 40-, 20-meter opera-	
tion.....	CQ Mar 48 p. 31
Mobile use.....	CQ Jan. 48 p. 22
as v.f.o.....	CQ May 46 p. 18, RN Mar 48 p. 57
SCR-284	
Mobile installation.....	CQ Mar 47 p. 26
Portable use.....	CQ Oct 46 p. 28
SCR-522	
Receiver (BC-624)	
2-meter operation.....	CQ Jul 47 p. 27
	RC Sep 47 p. 24, RN Oct 46 p. 35
Bandpass converter.....	QST Mar 48 p. 34
as FM increase.....	RC Jan 48 p. 38
Output increase.....	CQ May 48 p. 22
Transmitter (BC-625)	
2-meter operation.....	CQ Jul 47 p. 27
	RC Apr 47 p. 35, RN Nov 47 p. 35
6-, 10-meter operation.....	RN Apr 48 p. 50
	QST May 48 p. 58
SCR-536 Handie-Talkie.....	RC Jul 46 p. 684
TBY-7 Transmitter-Receiver, 6-	
10-meter operation.....	RN Oct 47 p. 39
TS-47/APR Test Oscillator.....	RN May 46 p. 32



L3 are each 2 turns, 1/2-inch diameter, No. 14 wire. The oscillator coupling is fixed, and the coil is supported by a small stand-off insulator mounted on the side of the cabinet. It is spaced about 1/8 inch from the plate end of the oscillator coil. Experiment to determine the exact spacing between the two coils L3 and L4. If the coupling is too tight, the 957 will pop out of oscillation.

The variable coupling for the detector is made by drilling two holes the

This is secured to the side of the cabinet. The front end of the shaft protrudes through a bushing on the panel. The antenna coils aren't secured in place until the set is in the cabinet.

The cabinet is 7 x 10 x 6 inches. It is made of 1/16-inch aluminum, held together with small angle irons and 6-32 screws. A handle is fastened to the top. The 5-inch PM speaker is mounted on the inside top of the cabinet. Several holes were drilled in the top of the cabinet to make a grill.

The antenna is a piece of 1/8-inch brass rod 38 inches long. This is one-half wave for the 2-meter band. A quarter-wave antenna 19 inches long will work just as well. The rod is soldered into a small banana plug; which is plugged into a jack on the rear right of the cabinet top.

Two 45-volt portable batteries in series are used for the B-supply, and a 1.5-volt hearing-aid battery is used for filament supply. A 4.5-volt battery furnishes microphone voltage. The B-batteries are located one on either side of the chassis, between the chassis and side of the cabinet. The filament and microphone batteries are underneath the chassis, secured to the bottom of the cabinet. Standard battery plugs and short cables are used to connect the batteries to the terminal strip.

With these batteries, several months' service may be expected, using the unit a couple of hours a day.

Little or no difficulty should be encountered in getting the equipment into operation. An absorption-type wave-meter, or a couple of stations of known frequency, can be used for "spotting" the band.

Reliable contacts over several miles can be expected under normal conditions, but of course location and height play a major part in the performance of v.h.f. equipment.

While there are no restrictions on

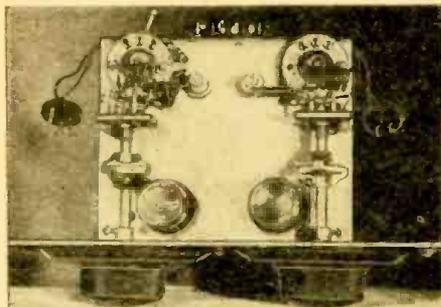

Fig. 4—Top view of the Handi-Dandy chassis.



Fig. 5—Transformers are under the chassis.

size of the No. 14 wire into a 1/4-inch polystyrene shaft about 6 inches long. The wire leads of L1 are passed through the holes and secured in place with a couple of drops of sealing wax. A bracket for supporting the shaft on the coil end is made by drilling a 1/4-inch hole through the center of a piece of 1/4-inch-thick polystyrene 1 inch square.

building and experimenting with radio equipment, a federal license is required to put a transmitter on the air, regardless of its size or power.

Amateur licenses are issued free of charge to any United States citizen and are obtained upon taking an examination at any of the radio inspectors' offices throughout the country.

## An S-Meter for Your Receiver

By H. HATFIELD

MANY hams have been searching for a simple and accurate S-meter to measure the strength of incoming signals and to provide visual tuning.

This S-meter will operate with any

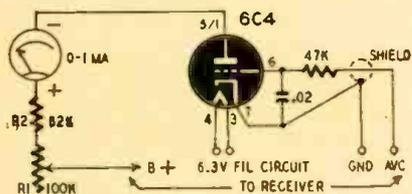

Fig. 1—This is the 1-tube S-meter amplifier.

broadcast or short-wave receiver having a.v.c and a 6.3-volt or a 0.3-amp. series filament supply. In sets having a 12.6-volt filament supply, a 12AT6 may be substituted for the 6C4. The B-supply may be either 100-165 or 225-350 volts.

The circuit, Fig. 1, shows that this S-meter works on the principle of a vacuum-tube voltmeter. A change in signal strength causes a change in the a.v.c. voltage, which is used to bias the 6C4. The resulting variations in plate current actuate the 0-1-ma meter, which is calibrated as in Fig. 2.

Use R1 to set the meter to zero signal (full scale) on any quiet spot on the band.

If the meter does not read 30 db on a powerful local station, reduce the B-voltage supply to the S-meter by con-

necting to the screen supply of the set or by any other convenient means. The resistance of R2 may have to be reduced.

The socket for the 6C4 and a 4-lug

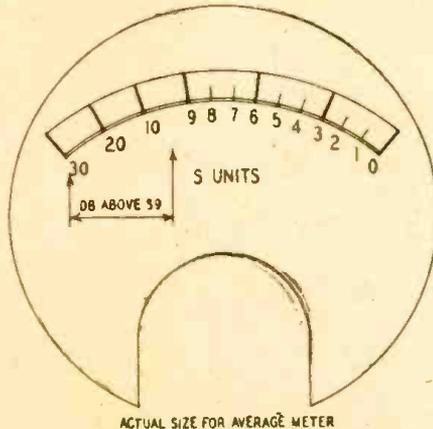

Fig. 2—Make a new meter scale as shown here.

terminal strip are fastened to a small metal chassis used to mount all components, including the meter. The a.v.c. wire must be shielded, and the shield is used for ground return to receiver.

### ANTENNA DOWNLEADS

I use a 40-meter folded dipole made of 300-ohm ribbon line. After the wind had torn the down lead from the antenna several times, I cut two pieces of

light-weight plastic (Plexiglas was handy) and drilled small holes in them as shown.

After connecting the transmission line to the center of the antenna, I clamped the ribbon between the two pieces of Plexiglas, passed screws through the holes, and tightened nuts on them.

The plastic apron protects the connections from the weather. The system weathered a windy winter and is still in good condition.

RICHARD HENRY,  
New York, N. Y.

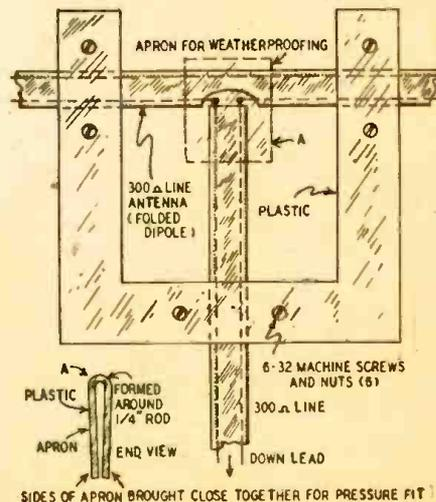

## MICROPHONE STAND

Dazor Manufacturing Corp.,  
St. Louis, Mo.

The Floating Arm is an adaptation from the desk lamp brackets made by the same manufacturer, the lamp being removed from the end and a standard threaded microphone holder substituted.

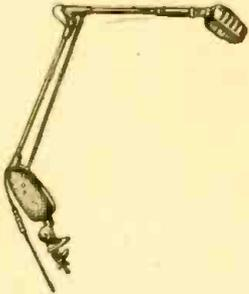

An advantage of the arm is that the microphone can be placed in any position—raised, lowered, or moved sideways—without the necessity of adjusting setscrews. The microphone will stay in any position in which it is set, according to the maker, because of a patented enclosed spring.

Much less bulky than the usual boom stand used for the same purpose, the Floating Arm may be obtained with a floor pedestal or with a universal mounting bracket permitting it to be clamped or screwed to any surface.—RADIO-CRAFT

## BATTERY VTVM

Hewlett Packard Co.,  
Palo Alto, Calif.

The 404A vacuum-tube voltmeter is housed in a metal carrying case and uses standard flashlight cells and 45-volt B-batteries as a power source. A.c. measurements from 2 to 20,000 cycles are accurate to  $\pm 3\%$ , with frequencies to 50 kc measurable to within  $\pm 7\%$ .

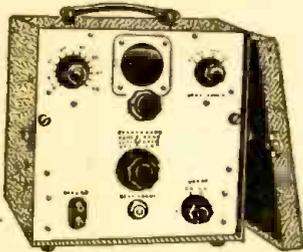

The range which may be measured with the 404A extends from .001 to 300 volts. Input impedance consists of 10 megohms shunted by 20  $\mu\text{m}$ .

Audio measurements are facilitated by the decibel scale. Continuous readings from -62 to +52 db may be taken. The instrument may also be used as a high-gain a.f. amplifier.—RADIO-CRAFT

## TAPE RECORDER

Amplifier Corp. of America,  
New York, N. Y.

The Model SP850 Magnetape Recorder is a high-fidelity unit, designed for professional and semi-professional use. Recording, monitoring, and playback amplifiers are contained within the rack-type cabinet, as well as the erase and bias oscillators and the mechanical components.

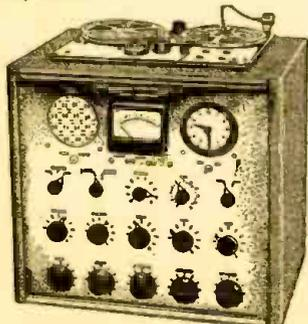

The VU meter, provided principally for visual monitoring, is also used to measure bias and erase voltages. An automatic timer permits the user to preset the unit to begin and

recordings at any time up to 12 hours in advance.

Three tape speeds are possible: the slowest affords an hour's recording time, and the fastest 15 minutes with frequency range to 12,500 cycles. Five input channels accommodate microphones, tuners, phonographs, and lines. The playback amplifier gives 15 watts output with less than 1% distortion. Variable equalizers are included.—RADIO-CRAFT

## TV SIG GENERATOR

Hickok Electrical Instrument Co.,  
Cleveland, Ohio

Model 610 Television Generator replaces the usual sweep generator, used with marker generator, trap alignment generator, and crystal calibrator. It permits the technician to align any of the 13 channels, i.f. stages, and traps, and to insert an accurate marker at any point on the i.f. response curve. Self-contained marker frequencies are directly calibrated on the instrument's dial.



The generator also provides crystal controlled signals from 1 mc to the top TV band.—RADIO-CRAFT

## FUSE-RESISTOR

International Resistance Co.,  
Philadelphia, Pa.

Type OWA resistors consist of small-diameter resistance wire well-spaced on an insulating core. The wire is bare and the winding is not coated.



Under normal conditions in the circuit, the resistor functions as usual, but if an overload occurs, the wire opens. The heat creates no smoke or fire hazard, since there is no inflammable material in contact with the wire.

These fuse resistors are useful in complying with underwriters' requirements in a.c.-d.c. receivers, as well as in protection of other types of equipment.

Resistance values from 15 to 150 ohms are available.—RADIO-CRAFT

## SELENIUM STRIPS

Standard Arcturus Corp.,  
Newark, N. J.

Kotron rectifiers are thin half-wave selenium units. The entire rectifier is constructed flat, rather than in usual



pile-up fashion. Cooler operation results, since heat can be dissipated directly, instead of being passed from one plate to the next.

The Kotron rectifiers employ no more than four rectifying elements, giving minimum voltage drop. They are available in 75-, 100-, and 200-ma. ratings.—RADIO-CRAFT

## PROTECTIVE TUBING

Walter L. Schott Co.,  
Beverly Hills, Calif.

Walsco Protecto-Tube is a flexible synthetic tubing designed for insulating the handles of pliers, screwdrivers, test prods, and similar tools.



The kit contains several sizes of tubing and a bottle of "expanding solution." To insulate a tool, the user selects tubing of a slightly smaller diameter than the tool. Dipping the tubing into the expanding solution swells it, so that it can be slipped over the tool. After drying, the tube shrinks, making a tight fit.—RADIO-CRAFT

## COIN RADIO

Tradio, Inc.,  
Asbury Park, N. J.

Described by the manufacturer as the smallest coin-operated radio in the world, the 6-tube Tradio-ette is 7/2



inches square and 5 inches deep. Designed to be placed in booths in restaurants and bars, the receiver has an r.f. stage, and a squelch circuit to silence interstation noise.

Installation requires only plugging in to the power line; a built-in antenna is provided. The aluminum cabinet contains the coin box. Playing time can be adjusted by the owner from 7 1/2 minutes to one hour. Maximum volume is preset to avoid annoyance to other patrons.—RADIO-CRAFT

## TELEVISION BOOSTER

Jerrold Electronics Corp.,  
Philadelphia, Pa.

The Jerrold Booster is a preamplifier which incorporates a selector switch to provide amplification on any of the 13 TV channels. With a minimum gain of 25 db on each channel and a full 6-mc band width, the unit makes good re-

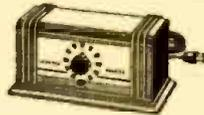

ception possible in areas of low signal strength. Multiple receiver installations, such as those in dealers' showrooms, apartment houses, and hotels, are also improved by the extra gain. In cities, the booster often eliminates the need for an outside antenna.

The unit is contained in a furniture-style walnut plastic cabinet whose dimensions are 7x4x4 inches. Built-in power supply operates from the 117-volt line.—RADIO-CRAFT

## PA AMPLIFIER

Altec Lansing Corp.,  
New York, N. Y.

The Model A-324 portable amplifier is rated at 15 watts output with flat frequency response from 20 to 20,000 cycles. Two low-impedance microphone inputs are provided, each with 95-db gain and a separate volume control. Two low-gain inputs permit phonograph and tuner connection.

Variable bass and treble equalizers are included.—RADIO-CRAFT

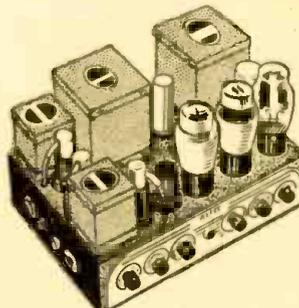

## V-O-M METER

Triplett Electrical Instrument Co.,  
Bluffton, Ohio

The Model 2405-A is a volt-ohm-milliammeter with a sensitivity of 20,000 ohms per volt on the d.c. ranges and 1,000 ohms per volt on a.c.

Voltages up to 1000 on a.c. and d.c., 50  $\mu\text{a}$  to 10 amps on d.c., and 500 ma to 10 amps on a.c. are included in its 35 ranges. The ohms range is from 0-40 megohms in 4 steps. A condenser is in series with the output voltage jack, and the ranges are the same as for a.c. volts.

## 'ANTENNA MOUNT

South River Metal Products Co.,  
South River, N. J.

The Chimney Mount antenna base is used to fasten FM and television antenna masts to chimneys. Two galvanized steel bands are passed around the chimney to hold the mount in position. The mast is inserted into the two vertical rings and held with setscrews.

Installation is said to take only a few minutes. Marring the brickwork by drilling holes in it is unnecessary.

The hardware furnished is rust-resistant, and the steel bands have a combined tensile strength of 3,000 pounds.—RADIO-CRAFT

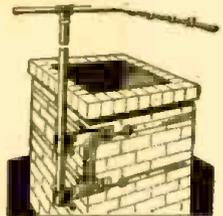

## POWER INVERTER

Electronic Specialty Co.,  
Los Angeles, Calif.

The Ranger Inverter converts 117-volt a.c. line voltage to d.c. Originally designed for use with vibrator-type electric shavers, which operate best on d.c., the inverter may be used in any application requiring 15 watts or less.—RADIO-CRAFT

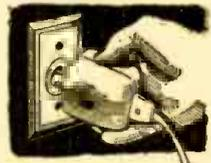

## TELEVISION PROJECTOR

Cortley Television Corp.,  
New York, N. Y.

This projection television can furnish a picture as large as 12x16 feet. Operation is said to be as simple as that

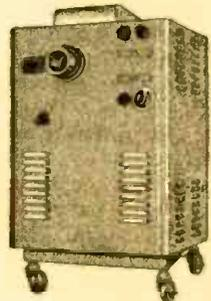

of a home movie projector; only four operating controls are furnished. A special plastic screen eliminates glare. Front or rear projection is controlled by a switch.

The metal cabinet, 35 inches high and 22 1/2 inches long, is mounted on rubber-tired wheels.—RADIO-CRAFT

## AUTOMATIC KEY

Electric Eye Equipment Co.,  
Danville, Ill.

The Mon-Key is an electronically timed automatic key that makes dots and dashes spaced in relation to their length. Also, it is a monitor, producing a tone that can be regulated as to volume or cut out entirely as may be desired.

Regardless of the speed to which the key is set (8 to 45 words per minute), dashes are always three times as long as dots. The spaces between successive dots or dashes are always equal to the dot length.

The Mon-Key is activated by a lightweight aluminum paddle-type key. It is not affected by vibration. The unit is basically a multivibrator, and does not operate on the adjustable-weight principle but is completely electronic.—RADIO-CRAFT

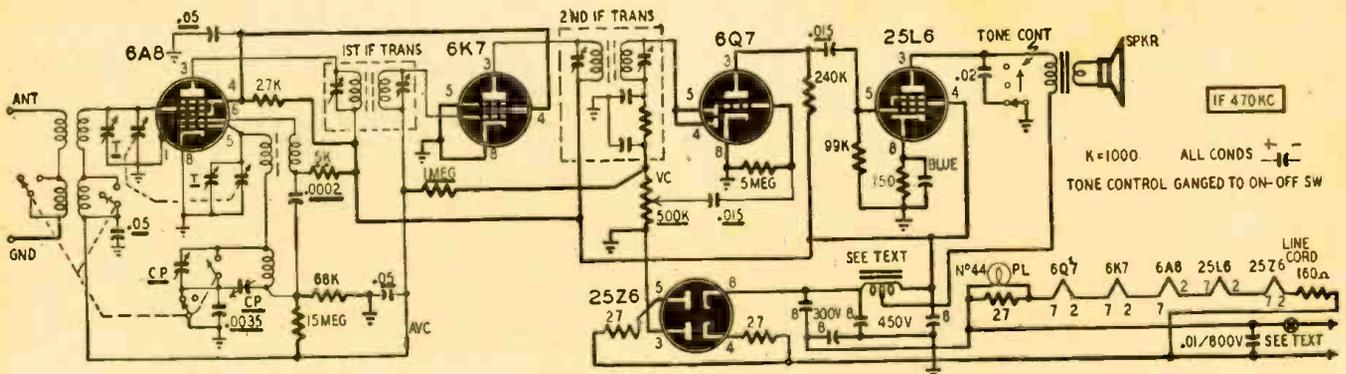

The battery tubes of the Philco Model 38-38 were replaced with those more suitable for operation from a transformer-less power supply.

# Converting Farm Sets For A. C.

## An opportunity for rural servicemen

By ALFRED SHORTCUT

**S**LOWLY but surely the Rural Electrification Administration is bringing power to localities where it was totally unavailable a few years ago. Most of the radios in these areas were operated from storage batteries or combinations of storage and dry batteries. Many of these sets are still in use in recently-electrified areas. The cost and inconvenience of battery charging and replacement can be overcome by converting them to a.c. operation. The Philco Model 38-38 is a typical 2-volt farm radio. The diagram shows how it was converted to a.c. operation using parts costing less than \$8. The heavy lines show circuit changes or new wiring. The portions of the circuit shown in light lines are not changed. Values of parts already in the set are underlined.

An a.c.-d.c. circuit was selected for economy and easy installation. The 1C7-G, 1D5-GT, and 1H4-G (second detector) sockets were rewired for the 6A8, 6K7, and 6Q7, respectively. The 1H4-G driver was replaced by a 25L6, and the 1J6-G by a 25Z6. The 1E5-GP socket was not used.

The first step is to rewire the filament pins in series with the 160-ohm line-cord resistor in the order shown in the diagram. Wire up the power supply, using the 25Z6 in a voltage-doubler circuit. B-drain is low so you can use the old driver transformer as a filter choke. If the primary is open—it usually is if the set has been out of service for a while—use the secondary. It will filter well and still carry the load. Take care when wiring the switch into the power line. One set of its contacts shorts to ground. If you use this section, you will short one half of the rectifier to ground. Use an ohmmeter and be sure.

The oscillator circuit requires little rewiring because the elements of the 1C7-G and 6A8 have corresponding pin

numbers. Tie the screen grids of the 6A8 and 6K7 together and connect them to B-plus through a 27,000-ohm dropping resistor. The original .05- $\mu$ f screen bypass stays in use. (Better make sure it's good.) The 1C7-G oscillator anode voltage was supplied through a filter network consisting of a 4- $\mu$ f condenser and 5,000- and 2,000-ohm resistors in series. Remove the 2,000-ohm resistor and the condenser, and connect the 5,000-ohm resistor to B-plus. Replace the 120,000-ohm oscillator grid resistor with a 68,000-ohm unit. The high side of this resistor is connected to the a.v.c. line through a 15-megohm resistor to

supply fixed bias for the 6A8 and 6K7 control grids. This permits operating their cathodes at ground potential.

A.v.c. is taken from the high side of the volume control and filtered through a 1-megohm resistor and a .05- $\mu$ f condenser. A 5-megohm resistor supplies contact bias for the 6Q7.

The power amplifier is the only stage with cathode bias. This is developed by a 150-ohm, 1-watt resistor. Connect the blue terminal of the original electrolytic condenser to the cathode of the 25L6. Replace the output transformer with one having a 3,000-ohm primary.

Disconnect the bottom end of the antenna primary from the chassis and connect it to the ground terminal so a doublet antenna or outside ground can be used. Realign the set.

## A WELL-DESIGNED RADIO SERVICING WORKBENCH

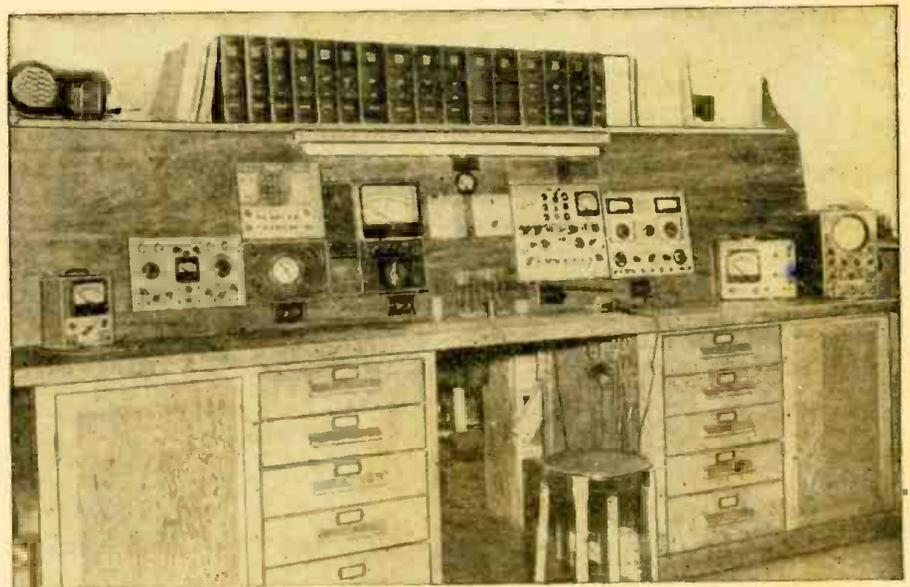

The service bench of Hambrick & Crecente, radio technicians of Moultrie, Georgia, has two complete sets of equipment that can be used simultaneously. Eight a.c. outlets and one 6-volt d.c. outlet provide operating voltages for a.c. and auto radios. Drawers and compartments provide ample storage space for spare parts, tools, wire, and public address equipment.

RADIO-CRAFT for

# New 1948 and F.M. Manuals

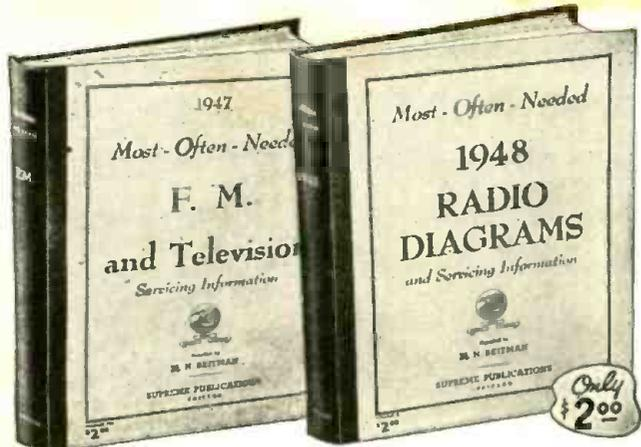

## F.M. and Television

Use this new giant manual of factory instructions for troubleshooting, repairing, and alignment of any 1947-1948 F.M. and Television set. Every popular make, including new F.M. tuners, AM-FM combinations, and all types of television receivers. Detail circuit diagrams, theory of operation, test hints, alignment data, including both meter and oscilloscope methods. This is the material you need to fix any modern F.M. or Television set. Don't turn this profitable work away for lack of knowledge and information. Use this newest **Supreme** manual to save time and money on your very next F.M. job. Data presented on 192 large pages, 8½x11 in. Sturdy, manual-style binding. Just published. Special price.. **\$2.00**

## New 1948 Manual

Be prepared to repair quickly all new 1948 receivers. In this big single volume you have clearly-printed, large schematics, needed alignment data, replacement parts lists, voltage values, and information on stage gain, location of trimmers, and dial stringing, for almost all recently released sets. Makes toughest jobs amazingly easy. Find faults in a jiffy. Speed-up all repairs. The time saved on your next job will pay the \$2 bargain price for the complete manual—after that you use it **FREE**. A worthy companion to the 7 previous volumes used by over 120,000 shrewd radio servicemen. New manual covers models of 42 different manufacturers. Giant size: 8½x11", 192 pages + index. Manual-style binding. Price only **\$2.00**

## BIGGEST BARGAIN IN RADIO DIAGRAMS

Make these two new mammoth volumes your money-saving source for data on all recently released receivers. Learn about modern circuit developments, be ready to repair any new radio no matter how complex. You pay only \$2 for each of these large manuals. With these two volumes on your workbench there is nothing else to buy, nothing else to pay—a whole year of radio diagrams and service data yours for a couple of dollars total. Again **Supreme Publications** beats all competition and gives radio servicemen greatest bargains in service information. Other volumes for previous years described below. **No-risk** examination granted to servicemen.

## FIND ALL RADIO FAULTS DOUBLE-QUICK

You can speed-up and simplify radio repairs with **SUPREME PUBLICATIONS** Manuals. Service all radios faster, better, easier, save time and money, use these **most-often-needed** diagram manuals to get ahead, earn more per hour. For the remarkable bargain price (only \$2 for most volumes) you are assured of having in your shop and on the job, needed diagrams and other essential repair data on 4 out of 5 sets you will ever service. Every popular radio of all makes from old-timers to new 1948 sets, including F.M. and Television, is covered. Clearly printed circuits, parts lists, alignment data, and helpful service hints are the facts you need to improve

your servicing ability. Save hours each day, every day, begin to earn more by making repairs in minutes instead of hours. Let these manuals furnish you with diagrams for 80% of all sets. There is no need to spend large sums for bulky, space-wasting manuals, or to buy additional drawings every few weeks; be wise, use **SUPREME** Manuals to get the most in diagrams and service data for the smallest cost. Act today and be money ahead with **Supreme Publications**.

**Models Made by:**  
R.C.A., Zenith, Philco, Sears, Fada, Emerson, Belmont, Detrola, Crosley, G.E., Westinghouse, Arvin, Majestic, Stewart-Warner, Admiral, Delco, Stromberg-Carlson, Wards, West'n Auto, Sparton, Motorola, and many others.

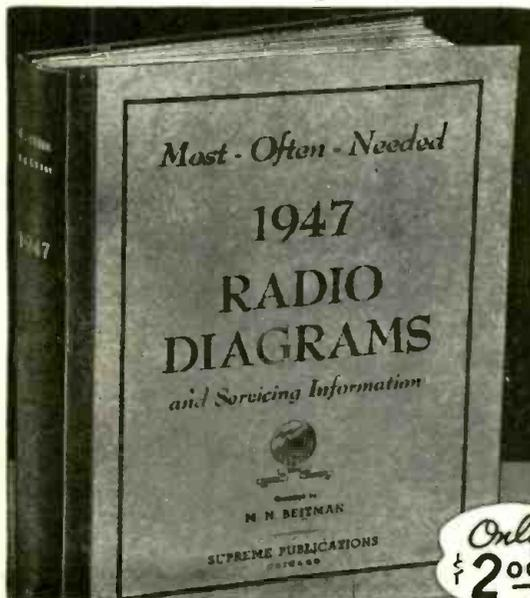

**Use coupon to order manuals for examination**  
Popular sets of all makes from 1926 to 1948 are included.

Select **Supreme** Diagram Manuals and Record Changer Books you want to examine. Send the no-risk trial coupon. Use the manuals in your own home or shop for 10 days at our risk. See for yourself how easy it is to fix all sets with the right data. You will agree that **Supreme Publications** are the greatest values in service manuals. You must be completely satisfied, or return manuals and get your money back.

## Record Changers Manuals

### Post-War Models

Service expertly all modern (1945-1948) record changers. All popular makes. Just follow simplified factory instructions to make needed adjustments and repairs. Hundreds of photographs and exploded views. Large size: 8½ x 11 inches. 144 fact-filled pages. Price only \$1.50 postpaid.

### Pre-War Models

Just what you need to repair quickly thousands of pre-war (before 1942) automatic record changers, manual units, pick-ups, wireless oscillators, recorders, and combinations. Hundreds of mechanical and electrical diagrams. 128 large pages; giant size: 8½ x 11 inches. Price, only \$1.50.

See Your Radio Jobber or Send Coupon →

# Supreme Publications

PUBLISHERS OF RADIO BOOKS, MANUALS, AND DIAGRAMS

9 South Kedzie Ave.

Chicago 12, Illinois

AUGUST, 1948

## NO RISK TRIAL ORDER COUPON

**SUPREME PUBLICATIONS, 9 S. Kedzie Ave., Chicago 12, ILL.**

Ship the following manuals on trial under your guarantee of satisfaction or money-back.

- New F.M. and Television Manual.. \$2.00
- Post-War Record Changers..... 1.50
- Pre-War Record Players & Recorders 1.50
- I am enclosing \$..... send postpaid.
- Send C.O.D. I am enclosing \$..... deposit.

- 1948
- 1947
- 1946
- 1942
- 1941
- 1940
- 1939
- 1926-1938 — \$2.50

**PRICED AT ONLY \$2 EACH**

Name: .....

Address: .....

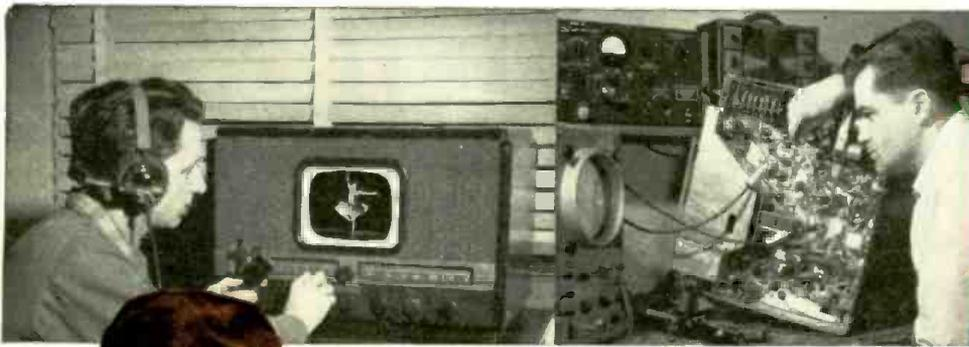

**Servicemen!**  
THE GREATEST  
NEWS OF THE  
YEAR—



*Introducing—*  
**THE FIRST  
ALL SERVICE COURSE  
IN CREI HISTORY**

# "Television and FM Servicing"

**Practical On-the-Job Training Program for the Better Serviceman Who Wants Greater Earnings and Security In This Expanding Field**

**T**HIS basic CREI Servicing Course paves the way to greater earnings for you. Since 1927 thousands of professional radiomen have enrolled for our home study courses in Practical Radio Engineering. Now, for the first time, we introduce a Practical Servicing Course. You do not have to be, or want to be, an engineer to benefit from this course. It is written for *you* — the average good serviceman! It's not too elementary for the experienced. It's not "over the head" of those who have limited experience—if they have real ambition and natural ability.

CREI developed this course at the request of several large industrial organizations. The urgent need of capable, trained servicemen is one of the big problems of the industry. Hundreds of thousands of Television

Receivers will be marketed in 1948. In years to come millions more will flow into American homes. With Television comes FM receivers and circuits. This new field demands a tremendous increase in the number of properly trained television and FM technicians to install and service this equipment.

## **CREI EQUIPS YOU TO INSTALL AND SERVICE ALL TYPES OF TELEVISION AND FM RECEIVERS**

Now . . . with the help of this new CREI streamlined Service course you can move ahead to unlimited opportunities in your chosen field. CREI has again taken the lead by offering a course so entirely new that for the first time in our twenty-one year history we can offer a down-to-earth course of training for servicemen. In offering this course at a popular price, CREI is enabling thousands

of the "top third" now engaged in service work to enter the ultimate profitable field of television and FM installation and service.

This can be your big year! Don't waste another day. CREI has the answer to your future security in this new servicing course. Write today for complete information. The cost is *popular*. The terms are *easy*. The information is *free*. Write today.

Radio Service Division of  
**CAPITOL RADIO  
ENGINEERING INSTITUTE**

*An Accredited Technical Institute*

**Dept. 588, 16th & Park Rd., N. W., Wash. 10, D. C.**

Branch Offices: New York (7) 170 Broadway • San Francisco (2) 760 Market St.

**MAIL  
TODAY**

**CAPITOL RADIO ENGINEERING INSTITUTE**  
16th & Park Road, N. W., Dept. 588, Washington 10, D. C.

Gentlemen:

Please send me complete details of your new home study course in Television and FM Servicing. I am attaching a brief resume of my experience, education and present position.

NAME \_\_\_\_\_

STREET \_\_\_\_\_

CITY \_\_\_\_\_

ZONE \_\_\_\_\_ STATE \_\_\_\_\_

I AM ENTITLED TO TRAINING UNDER G. I. BILL.



*Howard W. Sams*

presents the amazing  
**RADIO INDUSTRY  
RED BOOK**  
REPLACEMENT PARTS  
BUYER'S GUIDE

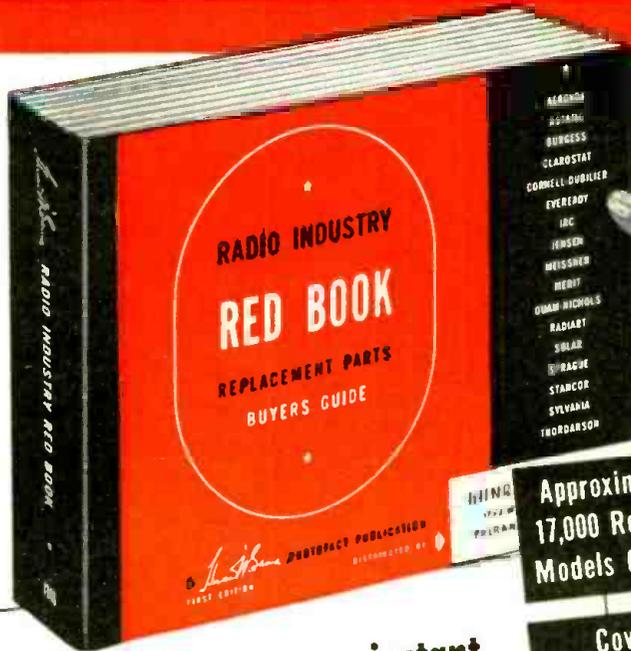

Approximately  
17,000 Receiver  
Models Covered

Covers  
Ten Years:  
1938 to 1948

Easy to Use:  
All Data  
Quick to Find

440 Pages  
Smythe-bound  
Opens Flat

**NOW**—a SINGLE authoritative volume that gives you instant reliable data on ALL replacement parts for thousands of popular radio receivers... more useful data than in all other replacement parts guides and manuals COMBINED...

**COMPLETE!**

The First Cooperative Industry Effort in Behalf of the Radio Service Technician

FOR THE FIRST TIME IN RADIO HISTORY!

All 9 Major Replacement Components Listed

(not just 1 or 2 components)

17 Leading Parts Manufacturers Represented

(not just 1 manufacturer)

**COMPLETE DATA ON ALL RECEIVER REPLACEMENT PARTS—ALL IN THIS ONE GREAT BOOK!**

Save time! Stop wasteful hunting! Get ALL the parts data you need—quickly—from this single book. NOW—for the first time—have all the replacement parts data you need—ALL in one single, authoritative volume. No more waste of valuable time searching through dozens of incomplete manuals and catalogs. The RED BOOK, first and only complete parts guide ever produced, covers approximately 17,000 radio models made from 1938 through 1947—10 full years. Lists parts made by 17 leading manufacturers—not just one! Gives you complete, accurate data on all 9 major replacement components—not just one or two! Clear, concise, easy-to-use—over 440 pages (8½" x 11") bound in a sturdy sewed cover, arranged alphabetically by manufacturer and model number for quick reference. Does away with confused collections of separate books and manuals—gives you complete information—PLUS data that cannot be found in any other source—at a fraction of the price you'd pay for the books it replaces. There's never been anything like it—absolutely indispensable for every service shop!

Only the RED BOOK gives you ALL this invaluable data. Here's everything you need to know about the replacement parts for the receivers you service daily. The RED BOOK gives you original manufacturers' parts numbers, proper replacement parts numbers and valuable installation notes on *Capacitors, Transformers, Controls, IF Coils* (including Peak Frequencies), *Speakers, Vibrators and Phono Cartridges, Tube and Dial Light* data includes number of tubes in each chassis, with type number for each tube, plus dial light numbers. *Battery* data includes replacement numbers on A, B, and AB packs. The following leading replacement parts manufacturers are represented in the RED BOOK:

- |                  |           |
|------------------|-----------|
| AEROVIX          | ASTATIC   |
| BURGESS          | CLAROSTAT |
| CORNELL-DUBILIER | IRC       |
| EVEREADY         | JENSEN    |
| MEISSNER         | MERIT     |
| QUAM-NICHOLS     | RADIART   |
| SOLAR            | SPRAGUE   |
| STANCOR          | SYLVANIA  |
| THORDARSON       |           |

18 months in preparation—over \$90,000 to produce. The RED BOOK is the product of thousands of man-hours spent in laboratory research and in cooperation with 17 participating manufacturers to produce the most complete, accurate, authoritative parts replacement guide ever published. Every bit of information in this amazing book has been painstakingly checked to insure maximum accuracy and usefulness. Over \$90,000 was spent to prepare the RED BOOK—the only book that brings you everything you need to know—every bit of replacement parts data you want to make your work easier and more profitable. You can't afford to be without the RED BOOK. It's the indispensable guide you'll use profitably every single day. Stop hunting for the right answers now—order your copy today.

**THE INDISPENSABLE RED BOOK... ONLY... \$3.95**

**BE SURE TO ORDER YOUR RED BOOK TODAY** →

HOWARD W. **SAMS** & CO., INC.  
INDIANAPOLIS 7, INDIANA

Mail This Order Form to Your Parts Jobber Today or send directly to HOWARD W. SAMS & CO., INC., 2924 E. Washington St., Indianapolis 7, Ind.

My (check) (money order) for \$..... enclosed.  
 Send.....RED BOOK(S) at \$3.95 per copy.  
(I understand that delivery will be made to me in September.)

Name.....  
Address.....  
City.....State.....

New York Telephone Company men watch as a crossbar dial system reports to its test frames at exchange "Watkins 9," New York.

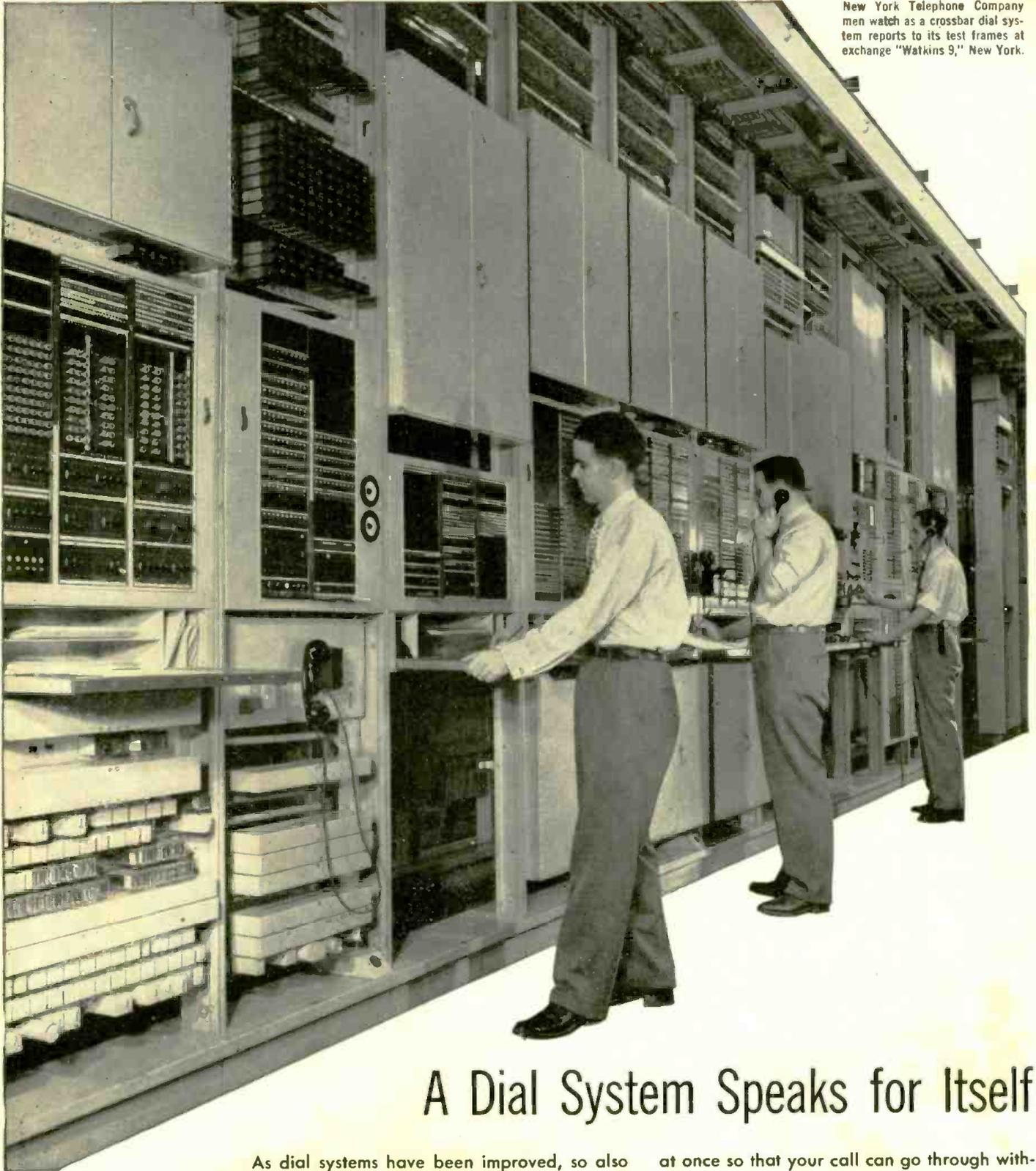

## A Dial System Speaks for Itself

As dial systems have been improved, so also have the means of keeping them at top efficiency. Even before trouble appears, test frames, developed in Bell Telephone Laboratories, are constantly at work sending trial calls along the telephone highways. Flashing lamps report anything that has gone wrong, and the fault is quickly located and cleared.

If trouble prevents one of the highways from completing your call, another is selected

at once so that your call can go through without delay. Then on the test frames lights flash up telling which highway was defective and on what section of that highway the trouble occurred.

Whenever Bell Laboratories designs a new telephone system, plans are made for its maintenance, test equipment is designed, and key personnel trained. Thus foresight keeps your Bell telephone system in apple-pie order.



**BELL TELEPHONE LABORATORIES** EXPLORING AND INVENTING, DEVISING  
AND PERFECTING FOR CONTINUED IMPROVEMENTS AND ECONOMIES IN TELEPHONE SERVICE

RADIO-CRAFT for

# Compact Radio From Holland

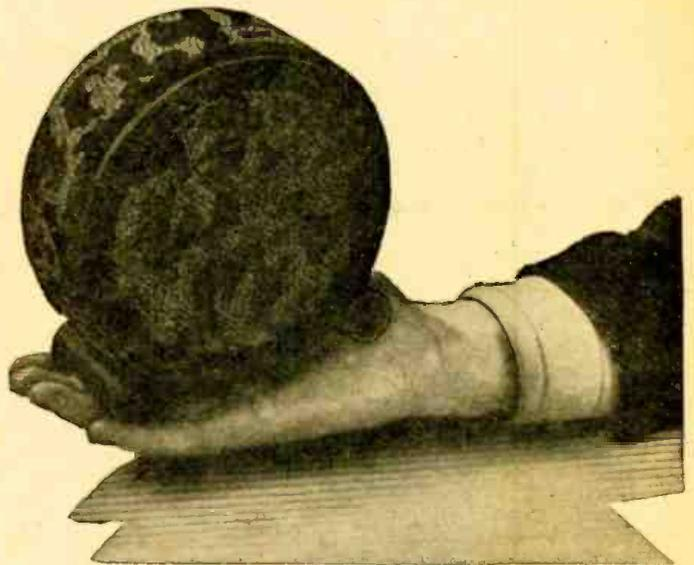

The little radio is built around and behind its own speaker.

**T**HIS little receiver is of Dutch origin and in its original form was about five inches in diameter by less than two inches deep. As described in *Radio Bulletin* (Bussum, Holland) it was constructed around the smallest of the Philips loud speakers, with all controls at the back.

Available American tubes and parts may make such extreme miniaturization impossible here, but the circuit is adaptable to standard U. S. equipment and might repay an experimenter for the time spent on it.

The set is a 1-tube, 2-stage receiver with a regenerative detector and resistance-coupled audio amplifier, including degenerative feedback. The 6AD7 is the only U. S. tube adapted to this circuit. (Original was a UCH21 or ECH-21.) An interesting feature is the antenna resistor used as a volume control.

This could be omitted and the regeneration control used to control volume as well. In that case, the antenna could be attached directly to the 200 $\mu$ f condenser connected to the antenna coil primary.

The original constructor used an ingenious switching arrangement which permitted tuning to three important stations on different wave bands with two coils and three sets of trimmers. The American constructor will probably prefer continuous tuning, either one band with a single coil, or with plug-in coils if the set is to be a short-waver.

In the upper position, the tone control switches in a feedback network to reduce highs. The small series capacitor limits feedback to the higher frequencies, so that the gain of the pentode is reduced more at the high end of the range than at the low end. In the lower switch position (as shown in the diagram) highs are attenuated slightly by the 200 $\mu$ f capacitor from grid to ground. This is done to prevent oscillation in the pentode.

Standard 3-winding broadcast or short-wave coils may be used. For broadcast use only, the antenna coil may be wound on a 1½-inch form with approximately 100 turns of No. 28 enamelled wire; the tickler coil may consist of 30 turns of No. 32 to 34 enamelled wire wound next to the ground end of the secondary; the primary can be 20 to 30 turns of the same wire wound in a close doughnut just small enough to slip inside the form, where it may be moved to provide best coupling.

For broadcast use, C1 may be 365 $\mu$ f and C2 160 $\mu$ f. For short-wave reception these may both be 140 to 160 $\mu$ f. Short-wave coils may be wound or standard coils obtained. Either commercial or homewound coils will require some experimental adding or subtracting of turns to fit each individual receiver. Suitable coil constants are:

Band	Pri Meters	Pri Turns	Secondary Turns	Spacing	Wire	Tickler Turns
10-20	2	6	1 in.	No. 18	4	
20-40	4	12	1 in.	No. 18	6	
40-80	8	20	own width	No. 23	10	
80-160	16	40	close	No. 23	18	

The ticklers of the 10-20- and 20-40-meter coils are woven between the turns of the primary. The others are close-wound about ¼ inch from the ground end of the secondary. Primaries may be ¼ to ½ inch away on the same form or wound inside as described for the broadcast coil. All primaries and ticklers may be wound with No. 32 or 34. All forms are 1½ inches in diameter. Although there are three windings, one terminal of each is common, so four-prong coils may be used. The usual reversing of the tickler is indicated whenever the set fails to oscillate.

Variations on the power supply are possible. Where miniaturization is not desirable, a full-wave rectifier with a tube might be used. A.c.-d.c. operation is not recommended, because of the high filament current of the 6AD7. However, the whole circuit could be adapted to dry-cell use with a 1D8-GT.

## AM TUNER

Here is a small AM tuner using a permeability tuning unit. The tubes are made by Sylvania, and are the type used during the war in proximity fuses. Except for size, the 1W5 is like the 1T4 and the 1Q6 is similar to the 1S5.

This particular tuner was made very small so that it could be hooked to a hearing aid. A small switch is installed in the aid to cut out the microphone and cut in the tuner.

CURTIS HILL,  
Jackson, Mich.

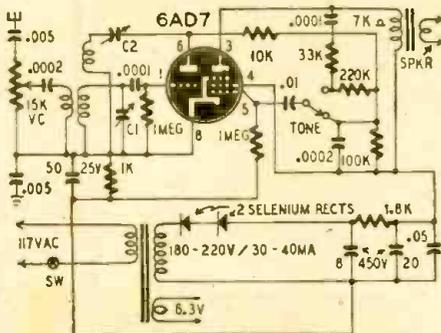
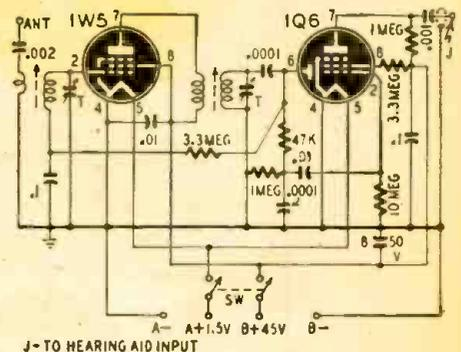

Modified schematic of the original receiver.

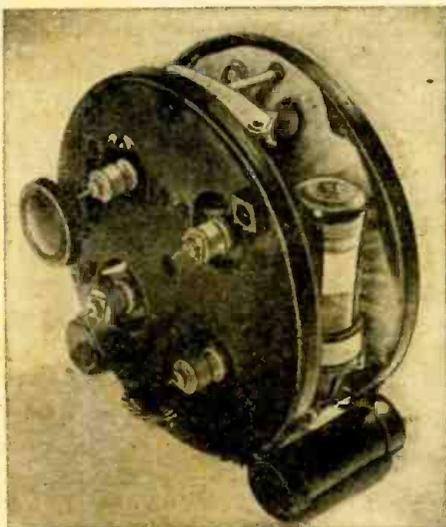

This back view shows the switch and trimmers.

**REMOTE CONTROLLED COIN INSERT AND SPEAKER BOX**

A



Made by Solotone Corp., Los Angeles  
 24 Volt operated, fused  
 Size of base 5½" x 8" x 10" high  
 Weight 11 lbs.  
 Front grill is sloping, illuminated by two pilot lights  
 PM speaker 6" size with matching transformer, screen and felt protective grills  
 Will accept 5c or 10c coins  
 Each 5c coin gives equivalent of two phonograph records  
 Has Haydon Mfg. Co. timer  
 Has lock installed in top. (with key.)  
 Coin box readily removable, size 3½" x 7¼" x 1¼" deep  
 Finished in attractive blue crackle metal, red plastic with chrome plated grill  
 Easily mounted on a wall or a flat base  
 This unit could be used to house coin operated radio

Original cost and selling price of this unit was several times our price. **\$4.75**  
**BRAND NEW** .....

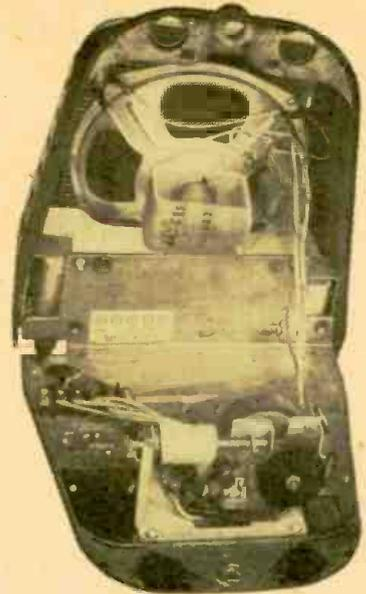

A OPEN VIEW

**REMOTE CONTROLLED COIN INSERT AND SPEAKER BOX**

B

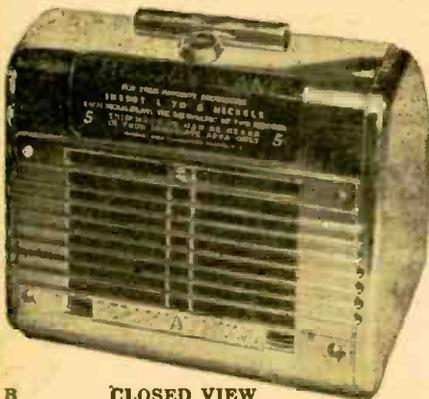

B CLOSED VIEW

Made by Personal Music Corp., Newark, N. J.  
 Model F  
 24 Volt operated, fused  
 Weight 6½ lbs.  
 Size 4¾" x 7½" x 5½" high  
 Sloping front  
 P M Speaker 5" size  
 Has 2 Pilot Lights for illumination  
 Finished in chrome metal and grill with red plastic  
 Accepts 1 to 6 nickels  
 Each 5c coin gives about two phono records of music  
 Should be mounted on a flat base  
 Has Haydon Mfg. Co. timer  
 Lock installed in top. (with key.)  
 Easily removable coin box, size 6" x 3½" x 1½"  
 Requires 4 wires from power unit  
 A beautiful piece of equipment that could be built to house coin operated radio  
 Worth several times our asking price. Price brand new **\$4.95**



B OPEN VIEW



**\$24<sup>75</sup>**

**ADAPTER-AMPLIFIER**

Made by Solotone Corp., Los Angeles

Model 2  
 115 Volts, 60 Cycles, fused  
 125 Watts input  
 15 Watts output  
 Tube line up 6J5, 6SL7, 6-6L6G's, 5 U4G  
 Crystal, Magnetic or 600 ohm line inputs  
 Individual volume, treble and bass controls  
 15 ohm output  
 Size 10½" x 15¼" x 8¼" high  
 Weight 30 lbs.  
 Chassis size 10½" x 15¼" x 3¼" high  
 Has meter to determine number of plays  
 Has 24 V AC output for the remote speaker boxes, fused  
 Toggle switch turns remote speaker boxes off and on  
 Black Crackle finish  
 Well ventilated  
 Built for continuous night and day service  
 Originally sold for several times our asking price. Price Brand New **\$24.75**



**\$24<sup>75</sup>**

**MASTER POWER SUPPLY UNIT for Measured Music System**

Made by Personal Music Corp., Newark, N. J.

Model F  
 110 V 60 cycle, input 300 Watts, fused  
 15 Watt output  
 Has high-low AC input line switch  
 Tube lineup: 2D21, 6AL5, 6SJ7, 6SN7, 2-6L6G's, 5U4G  
 Size 11½" x 17¼" x 10"  
 Chassis size 11½" x 17¼" x 2½"  
 Has Vernier volume, master volume, treble and bass controls  
 Gray crackle finish  
 Well ventilated  
 External handles for carrying it  
 Lock installed in top. (with key.)  
 Built for continuous night and day service  
 Originally sold for several times our asking price. Price brand new... **\$24.75**

TERMS: CASH WITH ORDER

**AMERICAN SURPLUS PRODUCTS CO.**

537 N. CAPITOL AVE. INDIANAPOLIS, IND.

# A Six-Tube Dry-Cell Superhet

## A 1.5-Volt Radio For Use in Rural Areas

By EDWIN BOHR

**A**N r.f. stage and two stages of i.f. are found in this receiver, its size has been kept down by the use of miniature button-base tubes which also increase efficiency.

Most battery-operated portables are designed for local reception only and are unable to pull in the weak stations. A

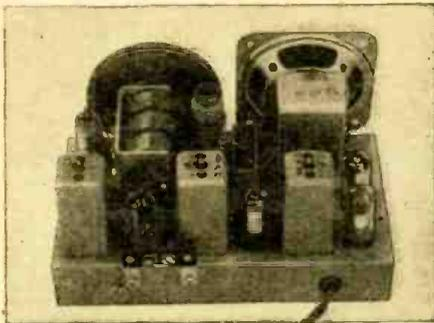

Though not a portable, set is very compact.

logical step for increasing sensitivity is to add an r.f. stage. The use of two i.f. stages on the broadcast band is not generally necessary, but, by using two stages and applying a.v.c. to only the first, the second can be made to function as an a.v.c. amplifier. This gives more satisfactory a.v.c. action.

An orthodox circuit consisting of a 1T4 r.f. amplifier, a 1R5 converter, two

1T4 i.f. stages, a 1S5 second detector and first audio amplifier, and a 1S4 in the output is employed.

The chassis should be cut and punched before mounting the parts: a slip of a drill may ruin a speaker or tuning condenser.

Grid leads should be pressed close to the chassis to reduce stray fields and troublesome oscillation. Use light, flexible hookup wire because the socket lugs are delicate and can be damaged easily. The difficulty of grouping parts around these tiny sockets makes terminal strips necessary. The holes in the centers of the sockets were made to be used in case future tubes had exhaust tips on the bottom. They serve admirably as ground lugs. The antenna coil should be mounted above the chassis, and the r.f. coil below. By using the center section of the tuning condenser for oscillator tuning, a source of feedback trouble is avoided.

A 4,700-ohm resistor and a .01- $\mu$ f condenser decouple the i.f. and r.f. stage B-supplies. This is necessary to prevent i.f. voltages from feeding back to the r.f. stage when the set is tuned to the low end of the band. The 1S5 plate is bypassed with a 100- $\mu$ f capacitor to reduce high notes and noise as well as to add to the r.f. filtering.

The speaker is mounted on the chassis by the bracket intended for an output transformer, instead of by the flange. This mounting method helps assure a microphonic-free radio. The speaker is a heavy-duty unit with a heavy magnet which contributes to the set's efficiency.

The tuning condenser used will tune to 1600 kc with a set of standard broadcast coils. The receiver is aligned in the usual way. Use the size padder the manufacturer specifies for the coils.

The 67½-volt B-battery was chosen because it could be placed in the bottom of the cabinet built for the set.

With suitable coils the receiver performs well on the short-wave bands.

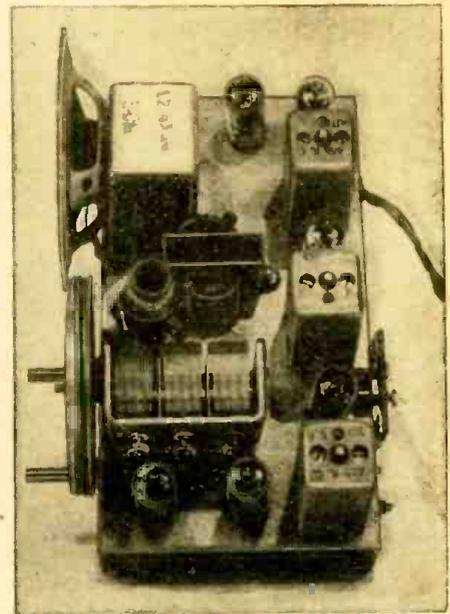

The six-tube superheterodyne is well laid out.

### 6-VOLT RECEIVER

Only a single 6-volt battery is used in this receiver for both filament and plate supplies. The tuning capacitor is a 365-

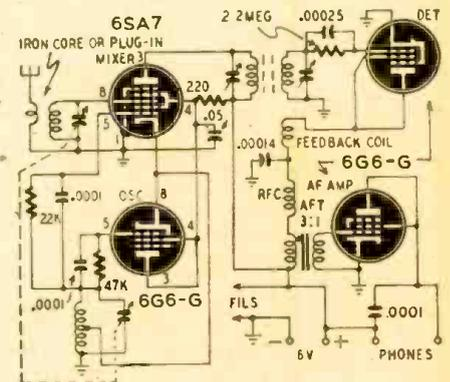

$\mu$ f-per-section unit and standard broadcast coils may be used. The i.f. transformer may be a standard unit with a regeneration winding or the extra winding may be added to an ordinary transformer.

JAMES C. SOUKUP,  
Randolph Field, Tex.

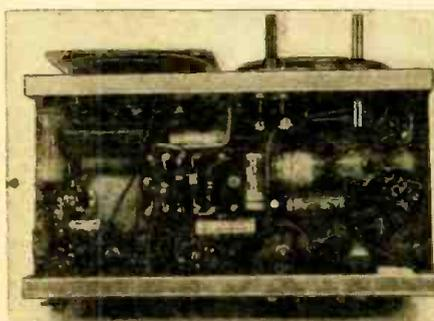

Underchassis photo shows placement of parts.

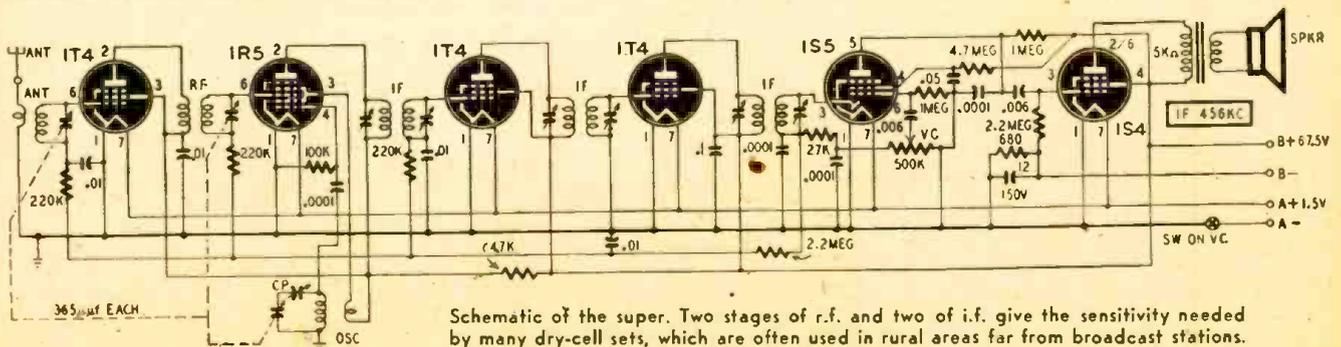

Schematic of the super. Two stages of r.f. and two of i.f. give the sensitivity needed by many dry-cell sets, which are often used in rural areas far from broadcast stations.

The New Model 247

# TUBE TESTER

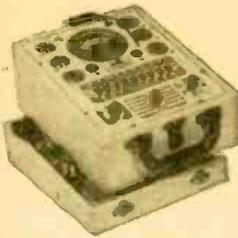

Checks octals, loctals, bantam jr. peanuts, television miniatures, magic eye, hearing aids, thyratrons, the new type H. F. miniatures, etc.

**FEATURES:**  
 ★ New element selector switch reduces possibility of obsolescence. ★ When checking Diode, Triode and Pentode sections of multi-purpose tubes, sections can be tested individually. A special isolating circuit allows each section to be tested as if it were in a separate envelope. ★ Checks for shorts and leakages up to 5 Megohms between any and all of the terminals. ★ The 4 position fast-action snap switches are all numbered in exact accordance with the standard R.M.A. numbering system.

Model 247 comes complete with new speed-read chart. Comes housed in handsome, hand-rubbed oak cabinet sloped for bench use. A slip-on portable hinged cover is included for outside use. Size **\$29.90**  
 10 3/4" x 8 3/4" x 5 3/4".  
**ONLY** NET

The Model 650—An AC Operated

## SIGNAL GENERATOR



**RANGE:**  
 100 KILOCYCLES TO 105 MEGACYCLES  
 ★ RF obtainable separately or modulated by the Audio Frequency.  
 ★ Audio Modulating Frequency—

400 cycles pure sine wave—less than 2% distortion.  
 ★ Attenuation—3-step ladder type of attenuator (T pad)  
 ★ Uses a Hartley Excited Oscillator with a Buffer Amplifier.  
 ★ Tubes: 6J5 as R.F. Oscillator; 6SA7 as modulated buffer and Mixer; 6SL7 as audio oscillator and rectifier.  
 Model 650 comes complete with coaxial cable, test leads and instructions. Housed in heavy gauge grey crystalline cabinet with two tone etched front panel. **\$39.95**  
 Size 9 1/2" x 10" x 6"  
**NET PRICE**

The New Model CA-11

## SIGNAL TRACER



Simple to operate... because signal intensity readings are indicated directly on the meter!

★ Simple to operate—only 1 connecting cable—no tuning controls.  
 ★ Highly sensitive—uses an improved Vacuum Tube Voltmeter circuit. ★ Tube and resistor-capacity network are built into the Detector Probe.  
 ★ Completely portable.

able—weighs 5 lbs. and measures 5" x 6" x 7".  
 ★ Comparative signal intensity readings are indicated directly on the meter as the Detector probe is moved to follow the Signal from Antenna to Speaker. Provision is made for insertion of phones.

The Model CA-11 comes housed in a beautiful hand-rubbed wooden cabinet. Complete with probe, test leads and instructions. **\$18.75**  
**NET**

Available for immediate shipment from stock—20% deposit required on all C.O.D. orders.

# MOSS ELECTRONIC DISTRIBUTING CO.

Dept. RC-8, 229 Fulton St., New York 7, N.Y.

## GREEN says . . . . LOOK! COMPARE!

FIRST TIME AT THIS PRICE  
 A REAL HOT SPECIAL . . . .  
 DETROLA RECORD CHANGER

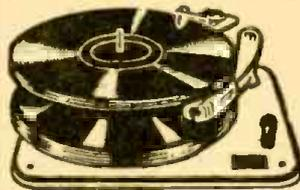

Plays 10 & 12" records automatically. Compact to fit most installations.

**SPECIAL \$11.95**

## UNHEARD OF VALUE! . . . . MAGNAVOX P.M. SPEAKERS

You all know the quality of these well known speakers. Need we say more?

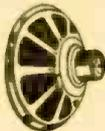

- 5" . . . . . \$1.39
- 6" . . . . . 2.05
- 8" . . . . . 2.95
- 12" . . . . . 5.95

## a TERRIFIC BUY . . . . . POWER TRANSFORMERS

These fully cased Power Transformers are of exceptional quality at less than 1/2 price.  
 TYPE A—90 Mills—700V c.t. 5V at 3 amps 6.3V . . . . . \$2.29  
 TYPE B—140 Mills—720V c.t. 6.3V at 5 amps & 5V at 3 amps . . . . . 3.69  
 TYPE C—160 Mills—700V c.t. 6.3V at 5 1/2 amps, 5V at 8 amps . . . . . 3.69  
 TYPE D—200 Mills—800V c.t. 5V at 3 amps 6.3V at 5 1/2 amps . . . . . 4.29

## PORTABLE RECORD PLAYER

3 tube amplifier, volume and tone control. Plays 10 & 12" records. Heavy Alnico 5" PM Speaker. In handsome simulated leather case, 12 1/2" x 10 1/2" x 4 1/4". Just plug in A.C. or D.C.  
 A \$24.95 Value



**ONLY \$15.79**

## Special! TELEVISION PARTS Special!

High Voltage tubular Television Capacitors. Pyro-treen Impregnated-Wax filled  
 .005 6000V . . . . . 38c  
 .01 6000V . . . . . 38c  
 .005 800V . . . . . 38c  
 .05 6000V . . . . . 58c  
 25 Popular assorted Ceramics . . . . . 49c  
 Dipole & Reflector Antenna . . . . . \$5.40  
 300 Ohm Line . . . . . \$1.30 per 100 ft.  
 72 Ohm Coaxial Cable . . . . . 4c per ft.  
 All Wave Television Boosters . . . . . \$20.50  
**THOUSANDS OF TELEVISION PARTS IN STOCK.**  
 WRITE US YOUR REQUIREMENTS.

## SPECIALS

### REPEATED BY POPULAR DEMAND

- 4 prong Universal type Vibrator . . . . . 98c
- Set of 2 IF Transformers 456kc . . . . . 78c
- 20/20 450V FP Condenser . . . . . 39c
- Motor & Pick-up, special Standard Brand. Both for \$4.29
- 2000V . . . . . 18c ea.

**THIS MONTH ONLY**  
 100,000 STANDARD BRAND TUBES in SEALED MANUFACTURERS CARTONS at the LOWEST PRICES  
 Write for Special Price List RC-2

ALL MERCHANDISE BRAND NEW AND 100% GUARANTEED  
 NO SECONDS! NO REJECTS! NO OFF-BRANDS!  
 STANDARD BRAND MERCHANDISE ONLY

20% Deposit required with C.O.D. Orders. All orders FOB New York. Minimum orders \$2.00. All orders must include shipping charges.

## THE HOUSE OF BARGAINS GREEN RADIO DISTRIBUTORS

Electronic Supplies & Equipment  
 482 SUTTER AVE. DI. 2-4444 BROOKLYN, N.Y.

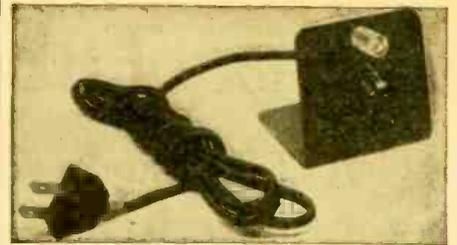

The neon lamp used as a photoelectric eye.

## NEON LAMP EXPERIMENTS

By HAROLD PALLATZ

MANY interesting and useful devices may be built from the ordinary fluorescent light starter, the type of starter containing a neon lamp. (Any 1/4-watt neon bulb will also work.) Remove the metal can and the capacitor from the starter.

Also needed are a 47,000-ohm, 1-watt resistor, a .003-μf capacitor, and a 500,000-ohm linear potentiometer. A source of 90 volts d.c. will be required for the oscillator experiment. This may be obtained from two 45-volt portable radio batteries or by tapping the voltage from an a.c.-d.c. receiver. If voltage from a receiver is used, be careful to avoid shock. It is a good idea to make sure the receiver chassis is connected to the grounded side of the power line. If a 117-volt lamp wired between chassis and ground lights, reverse the power plug.

### Audio oscillator

Connect the components as indicated in Fig. 1. A tone should be heard in the headphones, and adjustment of the control will change its pitch. If the neon is lit but no tone is heard, interrupt the supply voltage momentarily.

This is a relaxation oscillator, a type used in early oscilloscopes. The capacitor takes a certain length of time to charge. When it has charged to about 60 volts, the neon in the lamp ionizes or "breaks down," discharging the capacitor. Again the capacitor starts charging and again it is discharged by ionization of the neon. As a result, current through the headphones varies at a rate determined by the capacitance

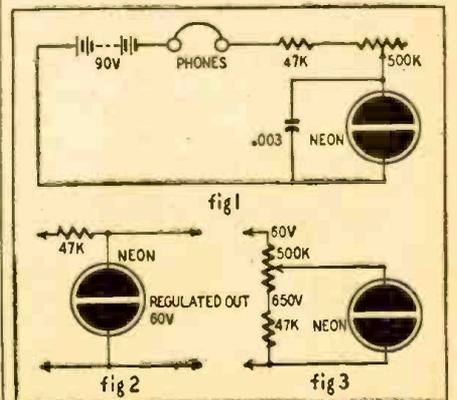

Figs. 1, 2, 3—Schematics for three of the experiments with fluorescent lamp starters.

**MONEY BACK GUARANTEE** — We believe units offered for sale by mail order should be sold only on a "Money-Back-If-Not-Satisfied" basis. We carefully check the design, calibration and value of all items advertised by us and unhesitatingly offer all merchandise subject to a return for credit or refund. You, the customer, are the sole judge as to value of the item or items you have purchased.

**THE NEW MODEL 670**

# SUPER METER



**SUPER METER. A Combination VOLT - OHM - MILLIAMMETER plus CAPACITY REACTANCE, INDUCTANCE and DECIBEL MEASUREMENTS.**

D.C. VOLTS: 0 to 7.5/15/75/150/750/1500/7500. A.C. VOLTS: 0 to 15/30/150/300/1500/3000 Volts. OUTPUT VOLTS: 0 to 15/30/150/300/1500/3000. D.C. CURRENT: 0 to 1.5/15/150 ma.; 0 to 1.5 Amps. RESISTANCE: 0 to 500/100,000 ohms. 0 to 10 Megohms. CAPACITY: .001 to 2 Mfd., .1 to 4 MfL (Quality test for electrolytics.) REACTANCE: 700 to 27,000 Ohms; 13,000 Ohms to 3 Megohms. INDUCTANCE: 1.75 to 70 Henries; 35 to 8,000 Henries. DECIBELS: -10 to +18, +10 to +38, +30 to +58. The model 670 comes housed in a rugged, crackle-finished steel cabinet complete with test leads and operating instructions. Size 5 1/2" x 7 1/2" x 3". **\$2840 NET**

**The New Model 450**

# TUBE TESTER

Speedy operation—assured by the newly designed rotary selector switch which replaces the usual snap, toggle, or lever action switches.



**SPECIFICATIONS**

\*Tests all tubes up to 117 volts. \*Tests shorts and leakages up to 3 Microhms in all tubes. \*Tests both plates in rectifiers. \*New type line voltage adjuster. \*Tests individual sections such as diodes, triodes, pentodes, etc., in multi-purpose tubes. \*Noise Test detects microphonic tubes or noise due to faulty elements and loose internal connections. \*Uses a 4 1/2" square rugged meter. \*Works on 90 to 125 volts 60 cycles A.C.

**EXTRA SERVICE**—May be used as an extremely sensitive condenser Leakage Checker. A relaxation type oscillator incorporated in this model will detect leakages even when the frequency is one per minute. **\$3950 NET**

**The Model S-35 — a POWERFUL**

# REFLEX PROJECTOR

**COMPLETE WITH**

**BUILT-IN DRIVER UNIT**

**CONSERVATIVELY RATED AT 35 WATTS—WILL EASILY HANDLE UP TO 55 WATTS WITHOUT BLASTING**

Heavy gauge aluminum in the main trumpet section completely eliminates blasting and blaring. New plastic diaphragm overcomes the resonant peaks of the old type; also it is absolutely impervious to atmospheric changes whereas the old type was subject to atmospheric corrosion. We are enabled to guarantee the unit for one year.



**Specifications**

**POWER (CONSERVATIVE)** — 35 WATTS; AIR COLUMN—3 1/2 FT.; **DISPERSION**—80°; **POWER (PEAK)** —55 WATTS; **BELL DIAMETER** —15"; **IMPEDANCE**—8 ohms; **FREQUENCY RANGE**—130 to 5000 C.P.S. **PROJECTION** — 1/2 mile; **FINISH** — Attractive two tone crystalline. The Model S-35 Comes Complete with Built-in Driver Unit. **\$2850 NET**

**The New Model 770 — An Accurate Pocket-Size**

# VOLT-OHM MILLIAMMETER



(Sensitivity: 1000 ohms per volt)

**Features:** Compact—measures 3 1/4" x 5 1/4" x 2 1/4". Uses latest design 2% accurate 1 Mil. D'Arsonval type meter. Same zero adjustment holds for both resistance ranges. It is not necessary to readjust when switching from one resistance range to another. This is an important time-saving feature never before included in a V.O.M. in this price range. Housed in round-cornered, molded case. Beautiful black etched panel. Depressed letters filled with permanent white, insures long-life even with constant use. **Specifications:** 6 A.C. VOLTAGE RANGES: 0-15/30/150/300/1500/3000 volts. 6 D.C. VOLTAGE RANGES: 0-7 1/2/15/75/150/750/1500 volts. 4 D.C. CURRENT RANGES: 0-1 1/2/15/150 Ma. 0-1 1/2 Amps. 2 RESISTANCE RANGES: 0-500 ohms. 0-1 Megohm. The Model 770 comes complete with self-contained batteries, test leads and all operating instructions. **\$1390 NET**

**THE NEW MODEL 777**

# 20,000 OHMS PER VOLT!!

# TUBE & SET TESTER

**Tube Tester Specifications:**

★ Tests all tubes including New Miniatures, etc. Also Pilot Lights. ★ Tests by the well-established emission method for tube quality, directly read on the scale of the meter. ★ New type line voltage.

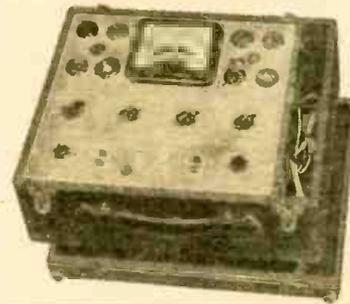

**V.O.M. Specifications:**

\* D.C. VOLTS: (at 20,000 Ohms Per Volt) 0 to 7.5/15/75/150/750/1,500 Volts.

\* A.C. VOLTS: (At 10,000 Ohms Per Volt) 0 to 15/30/150/300/1,500/3,000 Volts.

\* D.C. CURRENT: 0 to 1.5/15/150 Ma. 0 to 1.5 Amperes. \* RESISTANCE: 0 to 5,000/50,000/500,000 Ohms. 0 to 50 Megohms.

Model 777 operates on 90-120 volts 60 cycles A.C. Housed in beautiful hand-rubbed cabinet. Complete with test leads, tubes, charts and detailed operating instructions. Size 13" x 12 1/2" x 8". **\$5995 NET**

**The Model 88 — A COMBINATION**

# SIGNAL GENERATOR AND SIGNAL TRACER

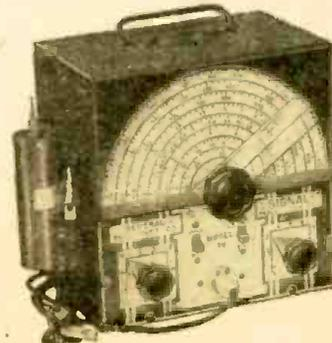

**Signal Generator Specifications:**

\*Frequency Range: 150 Kilocycles to 50 Megacycles. \*The R.F. Signal Frequency is kept completely constant at all output levels. \*Modulation is accomplished by Grid-blocking action which is equally effective for alignment of amplitude and frequency modulation as well as for television receivers. \*R.F. obtainable separately or modulated by the Audio Frequency.

**Signal Tracer Specifications:**

\*Uses the new Sylvania 1N34 Germanium crystal Diode which combined with a resistance-capacity network provides a frequency range of 300 cycles to 50 Megacycles. **\$2885 NET**

The Model 88 comes complete with all test leads and operating instructions. **ONLY**

**20% DEPOSIT REQUIRED ON ALL C.O.D. ORDERS**

**GENERAL ELECTRONIC DISTRIBUTING CO. DEPT. RC-8 98 PARK PLACE, NEW YORK 7, N. Y.**

**NOW! BUILD 15 RADIOS \$14<sup>75</sup>**  
 COMPLETE KIT ONLY...

**ABSOLUTELY NO KNOWLEDGE OF RADIO NECESSARY YOU NEED NO ADDITIONAL PARTS!**

**THE PROGRESSIVE RADIO KIT IS THE ONLY COMPLETE KIT**

Operates on 110-120 volts AC/DC. Contains everything you need. Instruction Book, Metal Chassis, Tubes, Condensers, Resistors and all other necessary radio parts. The 30-page Instruction Book written by expert radio instructors and engineers teaches you to build radios in a professional manner. The first circuit built is a simple one-tube detector receiver. Each succeeding circuit incorporates new arrangements of detectors, RF and AF amplifiers. This kit is excellent for learning the principles of receiver, transmitter and amplifier design. It is used in many radio schools and colleges. All of the commonly-used detectors are used, including diode, grid leak, plate and infinite-impedance. The transmitters are designed with Hartley and Armstrong oscillators, using screen-grid and control-grid modulation. Both vacuum tube and selenium rectification are employed in these circuits. The circuits are designed to provide excellent performance. Altogether, fifteen circuits are constructed, including 11 receivers, 1 audio amplifier, and 3 transmitters. The sets start with simple circuits of 1 tube plus rectifier, gradually grow more complex, and finish with several examples of radio sets using three tubes plus rectifier.

**PROGRESSIVE RADIO KIT . . . ONLY \$14.75**

**SPECIAL FREE OFFER**  
 Electrical and Radio Tester sent absolutely FREE with each Progressive Radio Kit. PLUS FREE membership in Progressive Radio Club. Entitles you to free expert advice and consultation service with licensed radio technicians. Write for further information or ORDER your KIT NOW!

**The Hottest Combination in Years!**  
**TOM THUMB CAMERA-RADIO Combination!**

It's here . . . the Cameradio, indispensable for trips, hikes, ball games, every outdoor and vacation activity. Combines a fine Reflex Camera and a powerful Radio into one easy-to-carry unit. Order now . . . you'll double the enjoyment of every weekend!

- Precision Built
- Excellent Tone Quality
- Full Vision Slide-Rule Dial
- The Ideal Vacation Companion
- Portable Radio Battery Operated
- Reflex Camera, Standard #127 Films

**ONLY \$28.75**  
 Less Batteries

**Automatic AUTO RADIO**

Tops in car radios, now at a new low price! Six-tube superheterodyne, with steady, full-toned reception. Mounting brackets included for easy installation in your car. Don't miss this big bargain!

- Six Tube Superheterodyne • Three Gang Condenser
- Powerful Long Distance Reception • Fits All Cars, Easy Installation • Mounting Brackets Included

**\$29.97**  
 Only

**EICO MODEL 315 SIGNAL GENERATOR**  
 with micro-cycle band spread vernier tuning

Vitaly important for tuning and aligning FM and Television receivers where tuning is very sharp and critical. The extreme wide range and accuracy afforded by the microcycle vernier band spread dial assures accurate frequency adjustment for broadcast FM or Television receivers. Vernier dial divided into 100 divisions. Any frequency can be tuned and repeated within .02% accuracy. Spring loaded split gears eliminate back lash and play providing smooth accurate tuning. Window casing encloses and protects the lighted dial and its fine pointer from accidents and jarring out of calibration.

Range 75 KC to 150 MC • Complete broadcast band from 550 KC to 1700 KC covered on one range without switching • Unused coils are automatically shorted out to eliminate dead spots and absorption • Linear dial calibration. DOES NOT CROWD-UP on high frequency end of dial • Accuracy better than .5% throughout the broadcast band and 1% on the higher frequencies • Just as accurate at high end of dial as at low end . . . . .

**\$64.50**

**VACUUM TUBE VOLTMETER**  
**MODEL 221**

A completely new and different vacuum tube voltmeter at an unusually low price. Its amazing performance sets a standard of accuracy, linearity, and stability not usually found in this type of instrument. Electronic AC ranges is more linear and accurate than was ever possible with a copper oxide rectifier. Completely electronic no meter can not be burned out. AC and DC ranges: 0-5, 10, 100, 500 and 1000 volt-Ohmmeter measures from .2 ohm to 1,000 megohms in 5 ranges. Each instrument is individually calibrated.

**\$49.95**

**PROGRESSIVE ELECTRONICS CO.** We pay Postage on Prepaid Orders. All C.O.D. Orders Shipped Collect.

WRITE FOR DEALERS CATALOGUE Dept. RC-16 497 UNION AVE. BROOKLYN 11, NEW YORK

and resistance in the circuit and the breakdown voltage of the lamp.

**Voltage regulator**  
 A neon bulb tends to maintain a constant voltage across its terminals, changing its resistance to compensate for any voltage changes. The voltage regulator in Fig. 2 will maintain a constant 60 volts regardless of line voltage fluctuations. Similar regulators were used in army radar equipment and are often employed in test equipment and in television.

**Voltmeter**  
 A neon-bulb voltmeter, wired as shown in Fig. 3, will measure a.c. and

d.c. voltages with fair accuracy. From 60 to 650 volts can be measured. A scale may be made of cardboard and pasted on the panel to indicate the voltage.

Start at the 650-volt side and advance the control until the bulb just lights. Do not advance the control past the point where the bulb just glows as the bulb may burn out. Calibrate with an ordinary voltmeter, a.c. or d.c. (or both) as desired.

**Photoelectric eye**  
 For the electric-eye experiment, simply connect the voltmeter just described to the 117-volt a.c. power line. Shade the bulb. Carefully adjust the control until the bulb is just about to glow. Then

bring a strong light close to it. This will make the bulb light. The light obtained is the result of the proximity of another and stronger light.

The operation of neon bulbs as light detectors is somewhat critical and care is necessary in finding the right adjustment. The action is due to ionization of the gas in the tube by the light, possibly coupled with photoelectric action by the plates. The experiment is somewhat similar to the famous one of Hertz on the breakdown of a spark gap by light. In his experiment a spark gap was used and just slightly less than breakdown voltage applied. Application of light ionized the air and permitted the spark to jump.

If desired, headphones may be inserted in series with the neon bulb; a click will be heard each time the light is interrupted.

**CONVERSADAPTOR**  
 This *Conversadaptor* is a cheap and compact method of adding a transmitter

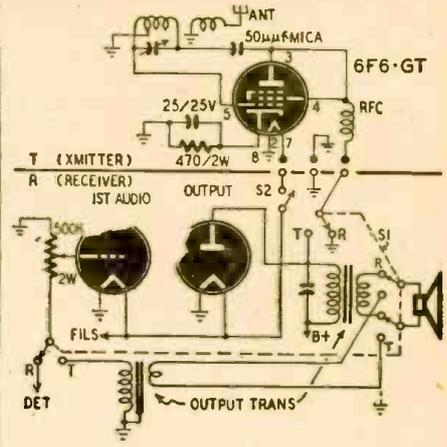

to a standard receiver so as to make it a transceiver.

The section labelled T in the diagram is an ultraaudion oscillator built on a 4 1/2 x 3 x 1-inch chassis. The section labelled R is the audio portion of the receiver to be used.



Subchassis holds the transmitting oscillator.



The PM speaker is used also as a microphone. With the 4-gang switch S1 in the receiving position as shown in the diagram, the audio input tube is connected to the receiver's detector and the speaker is connected to the audio output. Plate voltage is removed from the 6F6-GT oscillator tube.

With S1 in the transmitting position, the first audio grid is fed by the speaker as a microphone, and the oscillator is plate-modulated by the audio output tube.

The values of the oscillator coil and condenser will depend on the band used.

THEODORE S. GEORGILADAKIS,  
Crete, Greece

**AUTO RADIO CONVERSION**

The advantage of this converter circuit for an auto radio is that very few changes are necessary in the receiver, and the receiver can still be used on d.c. at any time. All new parts can be mounted on the cover of the metal receiver cabinet. To use the radio on a.c., disconnect the battery and plug the receiver into the line. Close S1, and throw S2 to the a.c. position.

It may be necessary to replace the speaker with a permanent-magnet type if a.c. hum occurs.

E. L. RAYNAUD,  
Mexico, D.F.

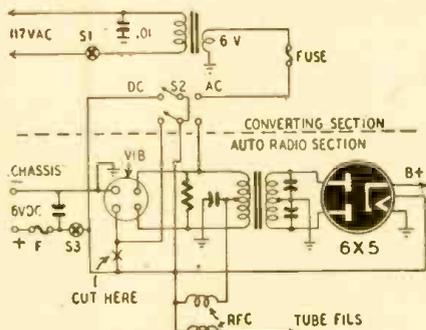

**SMALL SHIELD CANS**

Shield cans for small coils and miniature tubes can be made from the casings of old flashlight batteries.

Some of these have metal jackets in place of the cardboard ones. Straighten the flanges at top or bottom with long-nosed pliers, and slip the casings off the batteries.

The zinc outside of an ordinary cell can be removed by sawing off the top and bottom with a hacksaw, then removing the insides of the battery with a hammer and a large nail. Clean the inside of the zinc thoroughly with soap, water, and a small bottle brush. Try not to get the sticky material from inside the battery on your hands.

Solder small right angles to opposite sides of one end. Slide the shield over the coil or tube, then screw or solder the angles to the chassis.

When shielding coils, the zinc will often be better than the steel casings; they will lower the Q less.

K. E. FORSBERG,  
Sauk Centre, Minn.

**SERVICEMEN . . .** Satisfied customers are your best salesmen, and the amazingly improved record reproduction with the LEAR magnetic phonograph pick-up is a sure winner of these customers.

In this variable reluctance pick-up LEAR engineering has developed a "knee action" permanent sapphire stylus that steps over surface noise and actually transforms old style record reproduction into full, rich, mellow tones. It minimizes surface noise and assures full tonal beauty of sound on all installations. Fits practically any pick-up arm without alteration.

This is the reason more servicemen are turning daily to the LEAR magnetic phonograph pick-up as a means of extra profit with assurance of customer satisfaction. Don't wait! Write today for complete discount price list.

**LEAR PRE-AMPLIFIER**

**To Complete Your Sound Installation**

The new improved LEAR pre-amplifier provides additional amplification when used with MP-103 LEAR magnetic pick-up. Connects directly to old crystal cartridge input. Leads of convenient length are provided for connection into existing equipment. Two position switch permits high fidelity response to recordings. Can be furnished with an adapter to permit fast installation.

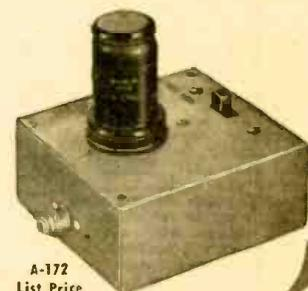

A-172  
List Price  
\$9.90

**FACTORY REPRESENTATIVES — DISTRIBUTORS:**

*A few choice territories are still available for these and other fine LEAR electronic products. Write today, giving full details.*



110 Ionia Ave. N. W. Grand Rapids 2, Mich.

Calling all  
Police cars



24 HOURS

Continuous Operation

CALLS FOR

# JAMES PUSH-PULL VIBRATOR

The Vibrator Which Definitely Outperforms

## OUTSTANDING FEATURES:

1. Frame cooled reeds (no stack to compress).
2. Push pull driving system (driving power squared).
3. Angular positioned reed arms.
4. Thick reed (.010 inch) and power to drive it.
5. Fully adjustable . . . every vibrator identical.
6. Proper reed stress distribution.
7. Large stationary arm heat dissipation area.

Complete Information and Replace Guide Available . . .  
See Your Parts Distributor . . . Or Write

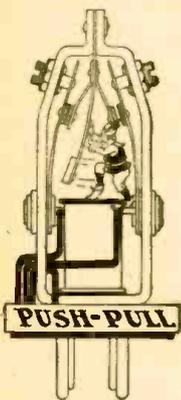

PUSH-PULL

## JAMES VIBRAPOWR CO.

3224 W. Armitage Ave.

Chicago 47, Illinois



## Better Products for the Radio Industry

### NEW G-C STATIC CHASER INJECTOR and POWER

Tire static powder kits — improve auto radio reception. Eliminates wheel static interference. New powder is blown into all the inner tubes—easy to use. For every car owner.

No. 5604—Injector for G-C Static Powder. . . . . List \$1.50  
No. 5605—G-C Static Powder Packet for 5 tires. . . . . List \$1.00  
No. 5606—KIT—One Powder packet and injector. . . . . List \$2.50

### NEW G-C FIELD CHASS EZ

Holds almost any radio chassis in position! Has special reversible hooks for flanged type chassis or to fill chassis back if necessary. Made with slide adjustment—takes only 5 seconds to install. No parts to lose—will never wear out. A real convenience for the radio serviceman!

No. 5207 Chass Ez . . . . . List \$3.65

### NEW G-C TUBE PULLER

Makes it easy to remove or insert miniature tubes—simple to operate. Inserts or extracts tubes where fingers will not reach—into hard-to-reach places. Saves time and money. Ends tube breakage, prevents burnt fingers.

No. 5093—Miniature Puller. . . . . List \$1.65  
No. 5093-D Display of 12. . . . . List \$19.80

### G-C "Speedex" WIRESTRIPPER

Strips insulation from wire sizes #8 to #30; including the 300 ohm twin F.M. and television lines. Ideal tool for manufacturers, electricians, maintenance men, etc. Strips 750 to 1000 wires per hour.

No. 733-12 to 20 wire. . . . . List \$6.00  
No. 733-K—Standard Speedex Stripper Kit, complete with seven different size blades. List \$15.00

G-C Products are available at leading distributors. Write for your copy of our new illustrated catalog.

Have you seen the new G-C "Speedex" Wire Strippers . . . write for illustrated literature.  
RADIO DIVISION DEPT. D

## GENERAL CEMENT Mfg. Co., Rockford, Ill., U. S. A.

Manufacturers of over 3,000 products • Sales offices in principal cities

## Construction

### DIRECTION INDICATOR

Aside from the antenna assembly and motor, this direction indicator for a rotatable antenna requires only a pair of square fiber boards, a couple of old volume controls, a 6-volt relay, and a few copper rivets.

The volume controls, mounted in the center of the fiber squares, are used only as bearings, so their "innards" should be removed. Around each control, in a circle, drill 15 accurately spaced holes. Mount a round-headed copper rivet in each hole. Attach a piece of spring brass to each of a pair of old knobs and bend it so that when the knob is placed on the shaft, the brass contacts each rivet in turn. Now mount the fiber squares on boxes so that they form the tops.

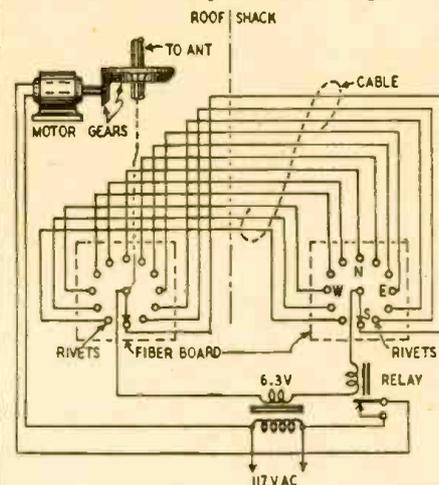

Mount one box in a convenient position under the antenna, and couple the antenna pole to the rotating contact, so that when the antenna rotates the contact will revolve in step with it.

Place the second box on the operating desk, and connect the studs of the two boxes with a cable. Be sure that each rivet of one box is connected to the corresponding rivet of the other.

In series with the power line to the antenna motor, place the contacts of a normally closed 6-volt relay. Connect one end of the relay coil to a 6-volt supply (a filament transformer will do) and the other to the rotating contact of the box in the shack. The other end of the 6-volt supply goes to the rotating contact of the box at the antenna.

To make the antenna point south, for example, place the rotating contact in the shack on the rivet contact which represents south (marked S in the drawing). Since the antenna motor's power circuit is complete (through the relay contacts), the antenna will rotate and the contact on the antenna box will go around with it. When this contact hits the "south" rivet, the 6-volt circuit will be complete and the relay will open. This will interrupt the supply of current to the motor; the antenna will stop.

If the antenna turns too freely, some kind of clutch may be necessary to prevent its coasting past the contact. If finer positioning is necessary, a greater number of rivets may be used in each box.

W. H. GIBSON,  
St. Catharines, Ontario

RADIO-CRAFT for

REGULATED SUPPLY

This regulated power supply uses the new RCA 5651 miniature voltage-reference tube. The circuit of the power supply is described in the tube's data sheet.

The grid of the right-hand section of the 6SL7-GT is furnished by the 5651 with a constant reference voltage.



When the load on the supply decreases, the output voltage increases. This increases the plate voltage on the right triode. The left grid, being tied to the right plate, also becomes more positive, and the left triode plate current in-

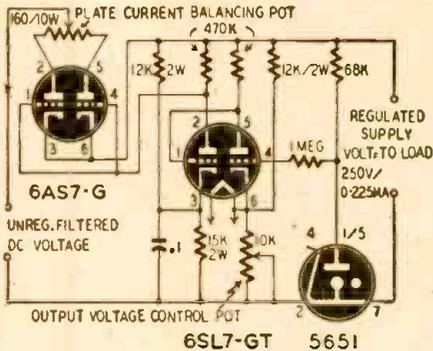

creases. This makes the left plate—and the 6AS7-G grids tied to it—more negative. Plate resistance of the 6AS7-G rises; and since the cathode-plate circuit of the 6AS7-G is in series with the positive side of the supply line, the supply's output voltage decreases.

At an output of 250 volts, variation is less than 0.2 volt for load currents of 0-225 ma.

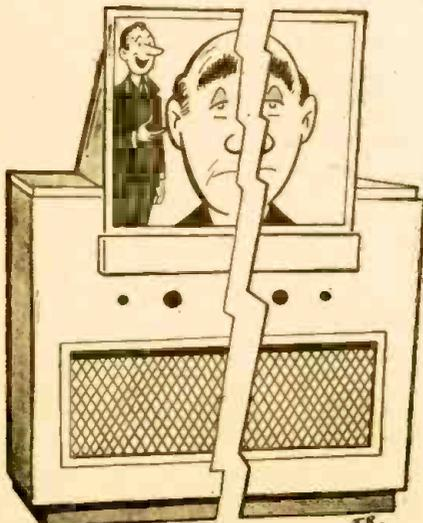

Suggested by: Grego Bانشuck, New York City

"This is the split personality type!"

Shurite PANEL METERS

- Ammeters—AC, DC
- Milliammeters—AC, DC
- Voltmeters—AC, DC
- Resistance Meters

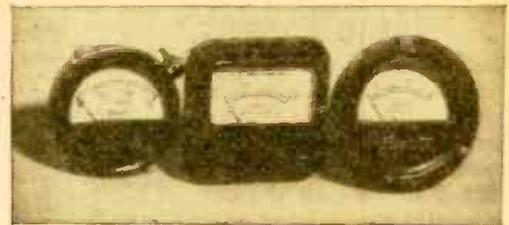

BIG VALUE BECAUSE...

- They're RUGGED** ... Sturdy construction throughout. Molded inner unit with coil frames and insulators integral for maximum rigidity. Exceptionally high ratio, torque-to-weight.
- They're NEAT** ... Dials are metal so they stay good looking in spite of age and moisture. Rich telephone black finish on brass cases. Concealed coils and good readable scales.
- They're SENSITIVE** ... Accuracy well within 5%. AC meters are double-vane repulsion type; DC meters are polarized-vane solenoid type. High internal resistance models available in popular ranges.
- They're GUARANTEED** ... For one year from date of purchase against defective workmanship and material, and will be repaired or replaced if sent to the factory postpaid with 25c handling charge.
- They're INEXPENSIVE** ... For instance, Model 950, 0-100 D.C.M.A. sells for \$1.45; Model 550, 0-15 D.C.A. for \$1.30. Other meters are correspondingly reasonable in price.
- They're AVAILABLE** ... Stocked by leading electronic distributors in a wide variety of types and ranges.

SHURITE METERS • 77 HAMILTON STREET • NEW HAVEN 8, CONN.

EXCITING! EXCITER BARGAIN

25 to 40 WATTS

10 to 80 METERS FOUNDATION KIT

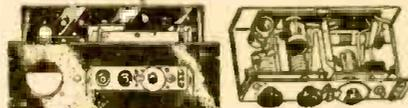

Engineered around the BC-610 series of plug-in tuning units. Described in the 11th edition Radio Handbook. Completed exciter uses 6AG7 crystal or electron coupled oscillator, 6L6 buffer-doubler and 807 amplifier. Kit includes four tuning units (illustrated at right above with cover removed), special 5 1/4" aluminum relay rack panel, socket for plug-in units and special hardware, together with full instructions and diagrams for assembling complete exciter. **\$9.95**

**PARTS KIT.** Everything needed to complete exciter except tubes and power supply. Includes all mica condensers, resistors, RF chokes, sockets, meter switch, D-200 ma meter, key jack, and miscellaneous parts. **\$9.31**

**DID YOU GET IT?**  
THE BIG B-A 1948 Catalog No. 481—  
Everything in Radio and Electronics. Write if you have not received it. **FREE** on request.



**SPECIAL**  
**Kay Television Antenna**—  
dipole reflector—5 ft. mast—takes 3 minutes to assemble. Price \$8.00 including postage. 300 ohm line, 2c ft. extra.

Send check or money order to  
**Kay Distributing Co., Inc.**  
446 West 50th Street, New York 19, N. Y.  
Phone Plaza 7-3816

TECHNICAL KO's

OIL-FILLED CONDENSERS		TRANSMITTING MICAS	
.05 MFD	1000V \$0.35	.000025	2500V \$0.15
.05	500V .14	.00005	2500V .15
.1	2500V .75	.00005	3000V .35
.1	7500V 1.65	.00005	5000V .85
2x.1	7000V 4.10	.000067	2500V .20
.12	15000V 7.95	.00007	2500V .20
.25	1000V .35	.00025	2500V .25
.25	4000V 2.15	.00025	5000V .65
.25	6000V 3.75	.0005	2500V .25
10x.25	800V 1.05	.00072	5000V .85
.5	600V .28	.0008	5000V .85
.5	1000V .40	.0001	2500V .25
.5	2000V .75	.0011	5000V .85
.75	400V .30	.002	1200V .20
.85	800V .35	.002	3000V .65
1.0	1000V .45	.00275	2000V .25
2.0	200V .20	.003	2500V .30
2.0	600V .40	.003	3000V .65
2.0	1000V .60	.004	2500V .35
4.0	800V .60	.005	1000V .15
4.0	1000V 1.00	.005	3000V .65
5.0	220VAC .55	.006	2000V .35
6.0	600V .70	.008	1200V .15
6.0	1000V 1.45	.01	1200V .15
8.0	600V .85	<b>TUBES-CHOKES-POTS</b>	
8.0	1000V 1.75	Tubes—6V6 Metal \$0.89	
10.0	600V 1.00	Tubes—12K3 Metal .29	
30.0	90VAC 1.40	Choke—100MA-10H, 250 Ohm 1.59	
30.0	330VAC 3.75	Pots: 20K-50K-100K .19	
25.0	25V .40	Dual. 1/2 Meg	
100.0	25V .50	250K-50K .30	

- SHIELDED WIRE #22 ... 50 Ft. for .65
- RESISTOR KIT Assorted 1/2 & 1W 100 for 1.49
- BATHTUB KIT 3x.1, .5, .05, ETC. 10 for .58
- CONDENSER KIT .01-.00001...100 for 2.99
- MICAS .01, .002, .005, ETC. All Values .08
- .01 150V PAPER (MIDGET) ... 60 for 1.00
- 0.1 600V PAPER ..... 8 for 1.00

\$2.00 min. order F.O.B. N.Y.C. Add postage 50% deposit, balance C.O.D. with all orders. Manufacturers inquiries invited, Send for Flyer. Prices are subject to change without notice.

**TECHNICAL RADIO PARTS CO.**  
265 Greenwich St. Dept. RC-3 N.Y. 7, N.Y.

**NEW** **INSIDE DOPE**  
ON **IDEAL AMPLIFICATION**  
SEND 3c STAMP FOR POSTAGE  
**AMPLIFIER CORP. of AMERICA**  
398-10 Broadway New York-13, N. Y.

### PHONO ADAPTER

The photograph shows a good method for making an extension for a phono-graph pickup cable or an adapter.

The receptacle housing is made from the shell of an old fluorescent lamp starter. The ears on the starter shell were lengthened by filing down the wall between them, then bent over the edge of the receptacle and soldered to the grounding connections. Shielded wire runs through a hole in the top of the shell.



This solves the problem of making a neat connection to a standard phono jack while preserving the shielding throughout.

JACK D. SELLERS,  
Detroit, Mich.

### INTERSTAGE TRANSFORMER

The driver transformer may burn out in old sets in which they were used. If no audio unit with a push-pull secondary is available, two single-ended transformers can be used.

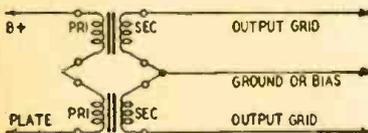

Connect the primaries and secondaries in series. Hook the primaries to the driver output as shown in the diagram.

Connect the secondary to the push-pull grids, using the junction between the two transformers as the center tap. If operation is not ideal, reverse the connections of one of the secondaries.

ORREN REYNOLDS,  
Dupont, Ohio

### TINNING IRONS

During almost every soldering job little drops of solder melt from the iron and fall on the bench, the chassis or even (the XYL doesn't like this) on the solderer's pants. When brushing off the bench, don't throw away these little solder chips. Collect them in an aluminum shield can.

After the collection has attained some bulk, put the can on the stove and let the solder melt. When it hardens, it will form one solid piece. To tin an iron, first file away the corrosion and then clean the tip with steel wool. Then dip the tip into the shield can, twisting the point around so that all parts are immersed in the solder. Take it out of the can, wipe

quickly with a piece of heavy cloth, and note the brightly tinned surface.

Tinning the iron this way is not only cheaper but also more efficient than using new solder from a spool.

RICHARD HENRY,  
New York, N. Y.

### RESISTANCE WIRE

While constructing a multimeter I needed some resistance wire to make shunts for the current ranges. I broke open an old tube and carefully unravelled the grid and screen wires.

One four-foot piece of this wire had a resistance of 200 ohms. Another was 2½ feet long and measured 5 ohms. Dividing 200 ohms by 4 feet told me that the first piece had a resistance of 50 ohms per foot; the other, 2 ohms per foot.

Knowing the resistance per unit length, it was an easy matter to cut exactly the length needed.

S. P. BRUNTON,  
Kingston, Ontario

### TV GLARE FILTER

Eye fatigue resulting from watching television programs is often due to the glare. To eliminate this, I fastened a piece of blue-tinted plate glass behind the front panel of the set, between the kinescope tube and the cabinet aperture. The glass is fastened to the rear of the panel by straps at the corners.

As well as eliminating glare, the glass improves contrast, permits viewing in a well-lighted room, and gives added protection to the tube.

Blue-tinted plastic, available at art stores, will work as well as glass, but if there is no protective glass in the cabinet, the plastic may be scratched.

ANTHONY DUTKOWSKI,  
Bayonne, N. J.

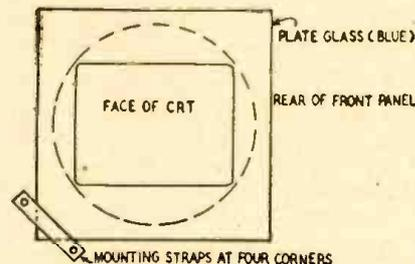

### AIR-CONDITIONED RECEPTION

When I was younger, my friend and I used to have fun talking from room to room through the furnace pipes. Recently, I made practical use of this idea when people in several rooms wanted to hear the same radio program.

I turned up the volume of my receiver and put it, speaker face down, on the cool-air intake in the living room. The program was heard clearly all over the house, and the cold-air intake does the radio no harm.

In the summer, when the furnace is turned off, the radio could be fed through any outlet in the house.

Although the fidelity probably suffers, the volume is entirely sufficient.

ARTHUR TRAUFFER,  
Council Bluffs, Iowa

### TIGHTENING GRILL CLOTH

A number of receivers that come into the shop for repair have sagging grill cloths.

A simple way to tighten them is to sprinkle or spray them lightly with water, and then let them dry overnight. The cloth shrinks and becomes taut.

Since water is distinctly unhealthy for speaker cones, it is a good idea to remove the speaker before sprinkling.

G. J. MACHEAK,  
San Pedro, Calif.

### PRESET VOLUME

A preset volume control can be a blessing where loud radios are annoying. Children can be prevented from upsetting mother's nerves by running the volume up on the more blood-curdling programs.

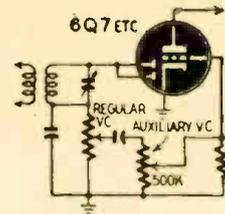

The auxiliary control, wired as shown, is placed in any convenient position away from prying fingers. It may be screwdriver-set. Sets using variable bias as a volume control may be preset with a variable 3,000-ohm resistor placed in series with the regular control.

FRED G. WILLMAR,  
Maywood, Ill.

### 6N6 SUBSTITUTE

The 6N6 tubes I needed for replacement in an old receiver are no longer available. 6K6's placed in the 6N6 sockets worked fine without any rewiring.

ERIC LESLIE,  
New York, N. Y.

### MODULATOR

Here is a method of modulating a flea-power rig when a modulator is not available.

A carbon mike is switched to the grid of the first audio tube of a small receiver. The low-impedance secondary of a plate-to-voice-coil transformer is placed across the receiver output, and the primary of the transformer is used to plate-modulate the transmitter.

S/SGT. BENEROGE, W1QYU,  
Greiner Field, N. H.

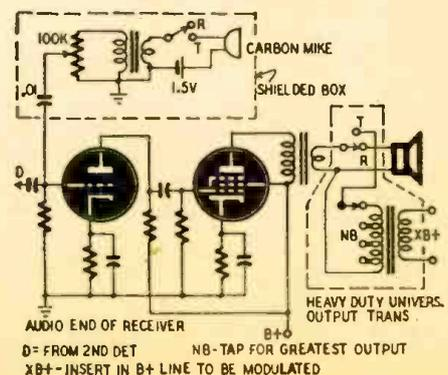

**SCREW SIZES**

If you own a small set of taps and dies, you can make a handy device for measuring screws. It will tell you what size tap to use to accommodate a certain screw or, if you keep your screws separated according to size, it will tell you which box a particular screw belongs in.

Drill and tap several threaded holes in a small oblong block of metal. There should be one hole for each size tap in the set, and the holes should be made from left to right in order of size. Use a block at least 1/4-inch thick. The handle of an old ten-cent-store dinner knife was handy in my case.

To determine the size of a screw, try fitting it into the holes. Screw it all the way in to make sure the pitch is correct. The block can be marked with sizes, but, since it is hard to mark metal, simply counting the holes from smallest up will tell you the size.

HENRY HOENIGSBERGER,  
New York, N. Y.

**MOUNTING SHUNTS**

When shunts are needed, to convert a meter for a greater current range, resistance wire is often used.

An easy way to make such shunts is to wind the wire on the outside of an insulated resistor. Use one with a resistance high enough not to interfere with the shunting. Wind the wire tightly about the resistor, then solder it to the pigtail leads.

Duco or similar cement may be used to hold the turns in place. The completed shunt may be mounted wherever it is needed, using the resistor leads for connection.

A. D. DENTON,  
Herts, England

**USEFUL OLD FILE**

An old three-cornered file with the sides ground down to sharp edges makes a good tool for stripping wire, scraping, and other operations.

The end of the file can be ground to a chisel shape. The end of the handle can be ground to a rounded point and will be useful for prying up wires which are being unsoldered.

EMIL EPP,  
Carrot River, Saskatchewan

**ISOLATION TRANSFORMER**

When servicing a.c.-d.c. receivers, isolate the set from the power line to prevent shocks. An inexpensive isolation transformer can be made by hooking two identical filament or toy transformers back to back. The primary of one goes to the a.c. line, the two secondaries are connected together, and the remaining primary feeds the receiver.

Be sure to use transformers with high enough wattage ratings. To determine this, multiply the rated secondary voltage by the rated secondary current. A 6.3-volt, 3-amp. transformer, for example, would be rated at roughly 18 watts.

CHARLES E. COHN,  
Chicago, Ill.



**Each Resistor is CLEARLY MARKED to show Resistance, Wattage and OHMITE Trade Mark**

Guesswork's gone . . . when you use genuine Ohmite Little Devil insulated composition resistors. Each unit, in all three sizes—1/2, 1, and 2 watts—is color-coded and individually marked for quick, sure identification.

Millions of these superior quality resistors are being used today by manufacturers, servicemen, and amateurs. They meet joint Army-Navy Specification JAN-R-11, including salt-water immersion cycling and high humidity tests. They can be used at their full wattage ratings at 70 C (158 F) ambient temperature. Little Devil resistors dissipate heat rapidly . . . have low noise level and low voltage coefficient.

Ratings for maximum continuous RMS voltage drop are high: 350 volts for the 1/2-watt unit, 500 volts for the 1-watt unit, 1000 volts for the 2-watt unit. All units have high insulation breakdown voltage.

Little Devils are completely sealed and insulated by their molded plastic construction. Leads are soft copper wire, hardened immediately adjacent to resistor body, strongly anchored, and hot solder coated. They're light, compact, easy to install.

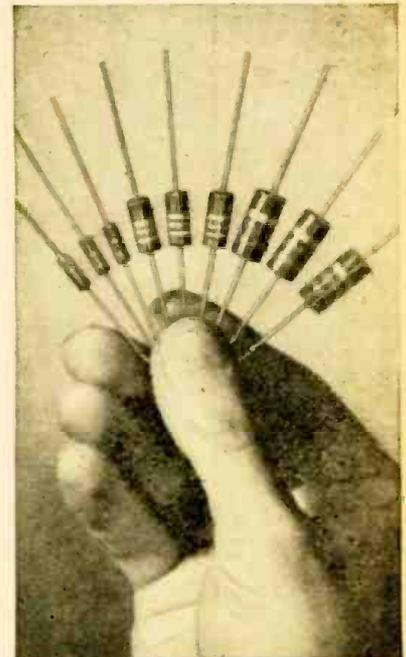

Little Devils are available in Standard RMA values . . . 10 ohms to 22 megohms. Tol. ± 10% and ± 5%. Values to 2.7 ohms available in 1-watt size, ± 10% tolerance.

**OTHER OHMITE PRODUCTS**

**BROWN DEVIL RESISTORS**—Rugged, dependable, wire-wound, vitreous-enameled. Easily mounted by tinned-wire leads. Tol. ± 10%. 5-, 10-, 20-Watt sizes. **DIVIDOHM ADJUSTABLE RESISTORS**—Used as multi-tap resistors or voltage dividers. Provide odd resistance values quickly. Vitreous-enameled. See your distributor for these and other Ohmite products.

**OHMITE MANUFACTURING CO.**  
4894 Flournoy Street • Chicago 44, Ill.

Be Right with  
**OHMITE**  
RHEOSTATS • RESISTORS • TAP SWITCHES

**SEND NOW**  
for BULLETIN 135

## LIGHTNING ARRESTER

Surplus T-R radar tubes, such as the 721, 1B25, 1B24, 1B27, or 702B, are used in this lightning arrester. If lightning strikes the antenna, it causes the tubes to break down and lead the charge to ground.

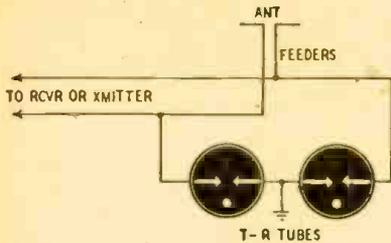

For maximum safety, the ground wire should be run in the same direction as the feeders from the antenna and should have no sharp bends. The lead-in from the tubes to the receiver should come from the arrester circuit at right angles to the antenna and ground leads.

This arrester may be used with transmitting antennas if it is inserted at a low-voltage point in the feeders.

CHARLES KNOOP,  
Saginaw, Mich.

## BATTERY CHARGER

After building some portable equipment, I discovered I had no way to charge the 12-volt storage batteries. Here is my inexpensive charger.

Two selenium war surplus rectifiers rated at 120 volts, 5 amperes, were purchased. As the diagram shows, they were arranged into a bridge circuit.

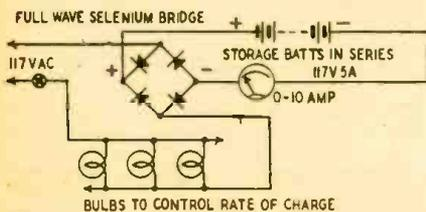

Up to three 12-volt batteries may be connected in series for charging. When using the charger, first connect the batteries, then insert a 25-watt lamp into one of the sockets, leaving the other two empty. After plugging into the 117-volt a.c. line, read charging current on the meter. If it is too low, change to a higher-wattage lamp, or add other lamps in the parallel sockets. The lamps act as line-dropping resistors; the higher their wattages and the more of them connected in parallel, the higher will be the charging current.

DAVID SIMON,  
Montreal, Quebec

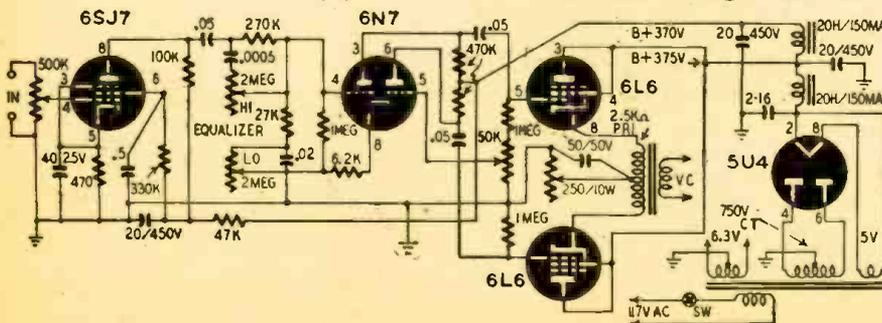

## CRYSTAL RECEIVER

Here is a crystal set which gives good results with a loudspeaker on strong local stations.

The two identical coils for the tuned circuits are 90 turns of No. 20 enameled wire on forms 1 1/2 inches in diameter and 3 1/2 inches long. After each coil is wound, cover it with a piece of wrapping paper and wind 30 turns of the wire over the center.

The set was constructed breadboard-style. The coil forms are mounted vertically 1/32-inch apart to give proper coupling. The 2-gang, 500- $\mu$ f-per-section broadcast tuning capacitor is attached to the base with wood screws. Fahnestock clips serve for antenna and ground connections.

To line up the receiver, tune in a strong signal, remove the speaker from the circuit, and connect a 1-ma meter in its place. Tune the trimmers for highest meter reading.

G. J. MACHEAK,  
San Pedro, Calif.

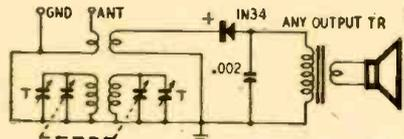

## PHONO AMPLIFIER

This amplifier uses a cathode-follower output stage. The triode-connected 6L6's give about 8 watts without any measurable distortion. They can be driven to about 11 watts, but distortion will appear. The output transformer need not be a high-fidelity unit, but it should be of reasonably good quality with a rating of about 15 watts.

The normal frequency response is uniform from 40 to 15,000 cycles. The equalizer circuit allows highs to be boosted about 6 db at 8,000 cycles, and the lows to be boosted about 7 db at 50 cycles.

It is very important that the 470,000-ohm plate resistors of the 6N7 phase inverter be well-matched. The power supply output voltages must be within 5 volts of those shown. Some adjustment of the voltage can be made by trying different values for the filter input condenser. Adjust the 6L6 cathode resistor until the tubes draw 110 ma.

Adjust the phase inverter by feeding a constant tone into the amplifier and (with a vacuum-tube voltmeter) measuring the audio voltage at each 6L6 grid. Adjust the 50,000-ohm potentiometer until these voltages are exactly

equal. This adjustment should be repeated periodically, since aging of the 6N7 may cause unbalance.

Despite the 6SJ7 voltage amplifier, the unit will not have enough gain for most microphones. The 6SJ7 merely restores gain lost in the equalizer network. The amplifier will, however, work well with a good phonograph pickup.

WILLIAM D. JOHNSON,  
Oakland, Calif.

## CONTACT MICROPHONE

A surplus T-30 throat microphone makes an excellent contact microphone for amplifying musical instruments. These small carbon units, which can be fastened to the instrument with Scotch tape, work best when the back of the microphone, rather than the rounded front, is against the wood.

The connection to the amplifier is shown in the diagram. If no carbon microphone transformer is on hand, a 3-to-1 audio interstage unit can be used. Adjust the 200-ohm variable resistor so that satisfactory operation is obtained with the greatest possible amount of resistance in the circuit. Don't forget to open the switch when the assembly is not being used.

KENNETH S. FERRIN,  
Fort Wayne, Ind.

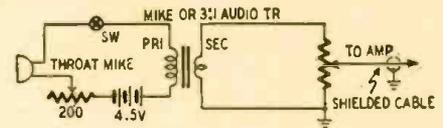

## BALANCING POWER TRIODES

A.f. power triodes, such as the 2A3, 6A3, and 6B4-G, are very susceptible to unbalance when used in push-pull. The circuit shown corrects this.

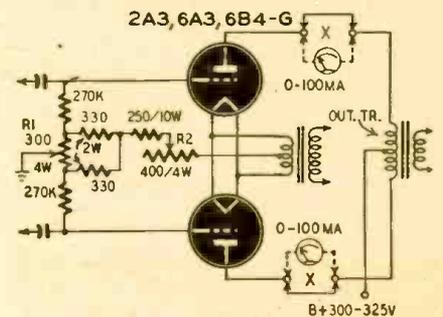

R1 is adjusted until the plate currents of the two tubes—measured by a milliammeter inserted at the points marked X—are equal. Then R2 is varied until the total plate current for the stage is of the proper value.

In this arrangement, each triode grid is above ground for d.c. The phase inverter which drives the power stage must be so connected that this d.c. does not appear on its grid. There will be no trouble if the split-load type is used; but if a voltage is tapped off the grid resistor of one of the power tubes to obtain the out-of-phase signal, a capacitor should be inserted to block the d.c. from the inverter grid.

M. HARVEY,  
Westfield, N. J.





**BRAND NEW SCR-625 MINE DETECTOR**

Attention, Prospectors, Miners, Oil Companies, Plumbers, etc.

Used by the Army to detect buried metallic mines. Its private use suggests the location of underground or underwater pipes, cables and ore-bearing rock, the location of metallic fragments in scrap materials, logs, etc., and the screening of personnel in plants for carrying of metallic objects. New, complete in original overseas packing container. Originally sold by War Assets for \$166.00. The U. S. Forestry Service has recommended procedure for using the SCR-625 Mine Detector to find concealed metal in tree logs and other timber products.

Price **\$79<sup>50</sup>**

Shipping Weight 125 lbs.  
Size: 8 1/4" x 28 1/4" x 16"

Batteries not furnished we can supply for \$4.50 extra

All Prices F.O.B. Indianapolis  
TERMS: CASH WITH ORDER

**AMERICAN SURPLUS PRODUCTS CO.**

537 N. CAPITOL AVE.  
INDIANAPOLIS, IND.

**WAR SURPLUS TERRIFIC BARGAINS**

- RADIO FILTER NEW, FL-3-A, ea. **75c**
- NEW RADIO RECEIVER BC-AC-229, with 5 tubes including 3/VT-49; 1/VT-37; 1/VT-38, wt. approx. 12 1/2 lbs. Mfg. by Western Electric Co. Only **\$4.75**
- NEW RADIO RECEIVER BC-341—A U.S.A. Signal Corp. type with 3 tubes, including 1/VT-103; 1/VT-91-A, 1/VT-104, in original packing. **\$3.95**
- Each
- SELSYN, MODEL #2J1G1, can be used on 110 V. 60 cyc. Instructions incl. New. **\$1.00 ea.**
- RADIO CONTROL BOX U.S. Army type with 3 positions selec. switch, vol. control. **50c ea.**
- JACK BOX NEW BC-366, U.S.A. Signal Corp. with 5 positions selective switch, volume control. **75c**
- Each
- ELECTRIC MOTOR 1/5 H.P. 27 V. D.C., **\$4.50**
- B. P. M. 3800, NEW, Each
- DYNAMOTORS NEW CHECK LIST AND ORDER NOW, ALL BRAND NEW AND PERFECT IN ORIGINAL INDIVIDUAL PACKING.
- DYN. NEW G. E. 485 KVA. Input 27 V.D.C. Output 115 V.A.C. Wt. 16 lbs. **\$4.50**
- DYN. NEW G.E. Type O. Input 28 V. A. Output 1000 Volts D.C. A. .35 Wt. 38 lbs. **\$4.95**
- Each
- DYN. NEW Type S. 3416-1 Input 9 V. output 400 V. 7 amps and .08 amps. Ea. **\$2.50**
- DYN. NEW MODEL #23350 Input 27 V.D.C. 1.75 Amps, Output 285 V.D.C. .075 Amps. **\$1.25**
- Each
- DYN. NEW, Model DY-22/ARC Input 23 V. D.C. Output 210 V. D.C. Each **\$1.50**
- RARE GENERATOR BARGAIN Guaranteed Brand New and perfect Navy Type #211220—A \*430 Volts D.C. 86 Watts. \*Length of SLEAFT 1 1/2". \*In original packing. \*Wt. 21 lbs. Shipping wt. approx 23 lbs. Chance of a lifetime to acquire a magnificent piece of equipment. Only **\$7.50**

Send check or money order. No. c.o.d.'s. Prices f.o.b. K.C. On orders \$1.50 or less please include 35 cents postage.

**GENERAL SALVAGE COMPANY**  
DEPT. 1, 2920 E. 27th St., Kansas City, Mo.

**WAR SURPLUS BARGAIN SPECIAL!**

Brand New  
**BEAM ANTENNA ROTATOR MOTOR**

**\$5<sup>95</sup>**

- Postpaid in Continental U.S.A.
- OPERATES DIRECTLY ON 110V AC, 60 CYCLES (Requires only 12 MFD Condenser)
- NO STEP-DOWN TRANS. NEEDED
- NO LINE RESISTOR NEEDED
- HIGH TORQUE — NO FREE SWING
- APPROX. 1/4 R.P.M.
- REVERSIBLE — ONLY THREE WIRES NEEDED
- ELECTRICALLY & MECHANICALLY QUIET
- LIGHTWEIGHT, RUGGED, QUIET
- MOTOR & GEARS OIL SEALED
- NO EXPENSIVE CONVERSIONS
- FLAT MOUNTING SURFACE — FOUR TAPPED HOLES
- FB. FOR 2-6-10-LITE 20 BEAMS

**ALVARADIO SUPPLY CO.**  
Dept. RC2, 903 So. Alvarado  
Los Angeles 6, California



... and radlomen especially are finding out that a coin radio operation in their locality is an easy, profitable adjunct to their own business. Requiring a minimum of investment in both time and money, Radio is a natural for big earnings and a steady, long time income. You merely place the sets on a percentage basis in hotels, motor courts, taverns, restaurants, etc., and let them work for you.

Send for complete information today | Write Dept. U-8

**TRADIO, Inc.** ASBURY PARK NEW JERSEY

been found sufficient with this type of circuit.

The transmitter hookup is conventional and several good contacts have been made with it. The receiver brings

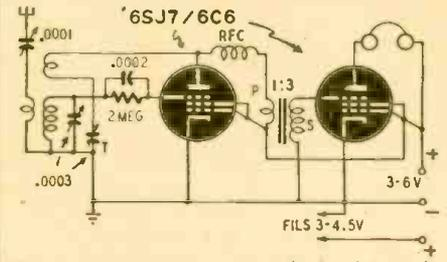

The 2-stage receiver uses only 6 plate volts.

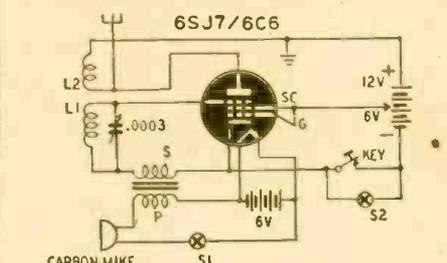

The transmitter can operate on c.w. or phone.

in numerous foreign stations, especially on short wave. Any desired band may be chosen by suitable plug-in coils.

This little station has been used as an interhouse communication system with excellent results.

The increased electron emission due to the positive voltage on the control and screen grids enables these tubes to operate efficiently on such low voltages.

P. T. NARASHIMAN,  
Tambaram, South India

(This equipment could be adapted to use dry-cell tubes, which would make it much more portable.—Editor)

**REMOTE THERMOMETER**

The temperature of a remote point is indicated by this electrical thermometer which works on the principle that the resistance of copper changes with temperature. It can be made entirely from old radio parts.

The circuit shows a 0-1 milliammeter drawing current from B1 through a fixed resistor and a rheostat. If the meter is connected as shown, this current will cause it to read in the usual direction.

The current from B2 is oppositely polarized, however, causing the meter to read backward. The difference in the two currents will be the actual reading of the meter.

The resistor labeled "coil" is actually an old loudspeaker field coil or any homemade coil of copper wire with a resistance of about 1,150 ohms. It is the sensitive element.

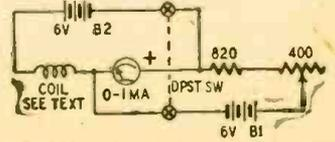

In winding the coil, a fairly small size of wire will be best in order to keep the finished product down to reasonable dimensions. A core should be used for convenience in winding. Any wood or paper



tube will do, since the coil is not required to act as an inductance. Scramble-winding is easiest and quickest.

If the coil is placed in the location whose temperature is to be measured, its resistance will change as the heat present varies. The resulting change in B2 current through the meter will cause a change in reading corresponding to the change in temperature.

To calibrate the unit, place the coil in a location which is as cold as the lowest desired scale marking. (The original unit went down to -10 degrees.) Note the reading of a good mercury thermometer in the same location, then mark this reading on the lowest point of the meter scale. Adjust the 400-ohm rheostat until the needle points to the marking.

Now increase the heat and mark other points on the scale, leaving the rheostat alone.

The sensitive coil may be located at any reasonable distance from the rest of the instrument. It should be dipped in paraffin for weatherproofing, but allow excess paraffin to drip off. Do not remove the coil from the circuit until the batteries are turned off. To conserve batteries, turn on the unit only when taking readings.

RUSSELL B. GARRETT,  
Hanover, Pa.

**A.C. WATTMETER**

This "wattmeter", which shows the amount of power drawn from the a.c. line by any receiver or amplifier, is very useful for detecting excessive power consumption which might be caused by shorted filter capacitors or by other bad parts.

Current through the transformer primary is determined by the amount of current drawn by the set under test, which is plugged into the a.c. outlet. The current in the secondary is determined by that in the primary. Secondary current is rectified by the small dry-disc rectifier and read on the 10-ma meter.

The transformer has a 6-volt primary. It was the power transformer of an old auto radio. Other meters may be used, or higher wattages, may be measured by shunting the meter.

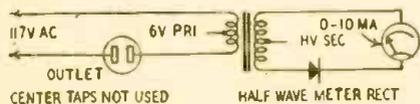

Open the meter and turn the dial scale over. On the white under surface mark the wattage calibrations. Plug in a 25-watt lamp, note meter reading, and mark the scale "25". Other lamps will give other calibration points.

After its initial calibration on 117 volts a.c., the wattmeter will be incorrectly marked for other voltages. However, for the normal variations between 110 and 120 volts, the error will not be important.

J. T. RODGERS,  
Bandera, Tex.

**PLATE CURRENT CHECKS**

Wherever it is important that equipment remain in service at all times, such as in a recording or broadcasting studio, this circuit should be valuable.

AUGUST, 1948

**YOUR 3 BEST BUYS**

**Kit Model B-4, A 4-Tube Portable Receiver**

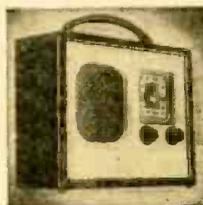

Model B-4 is our new 4-tube portable receiver which operates on self-contained batteries. Approximate size: 8 x 6 1/4 x 4. Uses the following tubes: 1R5, 1U4, 1S5 and 354. Power switch is conveniently located on front of set. Alnico 5 permanent magnet dynamic speaker. Case covered with fine grain leatherette. Complete with tubes, ready for assembly.

**Kit Model 210, a 3 Way Portable Receiver**



Model 210 operates on either AC or DC or self-contained batteries...power switch conveniently located on front of set so that "battery" or "AC or DC" may be selected without opening case. Five inch Alnico 5 permanent speaker. Case covered with fine grade leatherette material. Complete with tubes, ready for assembly.

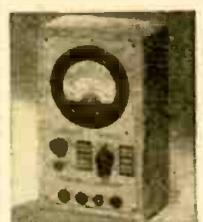

**Multitester Kit Model M-3C**

A versatile, compact multitester 4" x 7" x 3" using a 3 1/2" rd. meter of 1000 ohms per volt sensitivity. Employs the following ranges: Volts AC or DC 0/5/50/150/500/1500. Milliamperes DC 0/5/50/150. Ohms 0/2000/20,000/200,000.

Many other kit models available

Write for Catalog K

**RADIO KITS COMPANY**

120 Cedar Street New York 6, N. Y.

Disconnect all cathode resistors from ground, but leave the bypass capacitors grounded. Connect each resistor to one contact of a meter switch, as shown in

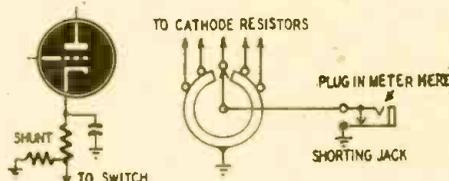

the diagram. (This is a Centralab type G wafer.) The almost circular rotor grounds all contacts except one. This one is led to a jack into which milliammeter leads are plugged. Cathode current of the tube associated with that contact will be read on the meter.

If all tubes in an amplifier are to be checked, determine the reading for the tube with the lowest normal current. Then insert a shunt, as shown, on each tube, to bring the meter reading to about the same point. The shunts will not affect the bias values.

Condition of each tube can be checked once a day or as required by plugging in the meter and rotating the switch. Any meter reading that is not normal indicates a tube that will probably fail. If it is replaced immediately, no more than a few seconds of operating time, if that, will be lost.

The jack is a shorting type so that, even if the plug is not in, the tube which is switched to the meter will continue to operate.

RICHARD HENRY,  
New York, N. Y.

*...Help end spark plug INTERFERENCE*

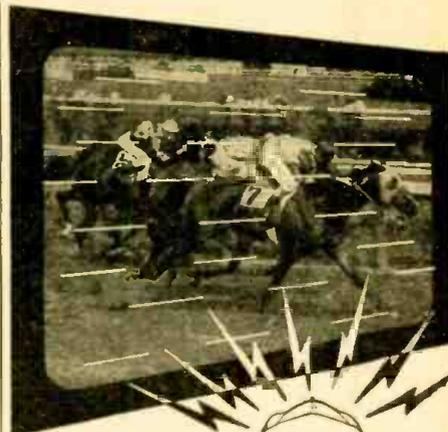

Spark Plugs are miniature broadcasting stations, send signals that interfere with radio reception, distort television. The New Auto-Lite "Resistor" Spark Plug reduces this interference.\*

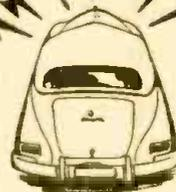

*Recommend NEW*  
**AUTO-LITE**  
*Resistor*  
**SPARK PLUG**

Here's How It Works to End Interference

The "Resistor" acts to dampen the spark plug radio signal to an acceptable level\* while still delivering the full high voltage discharge required to ignite the fuel.

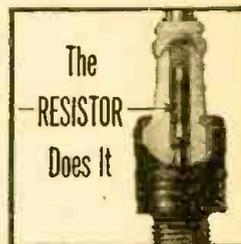

Auto-Lite Ignition Engineers, working with leading automotive manufacturers, have developed the new Auto-Lite "Resistor" Spark Plug with this built-in resistor that reduces spark plug interference.\* Remember, the "Resistor" also helps deliver smoother idling, improved economy, longer electrode life. Dealers are being supplied as rapidly as possible. Write for Booklet M-1186 for full information.

THE ELECTRIC AUTO-LITE COMPANY  
Toronto, Ontario Toledo 1, Ohio

\*Under 35mv/m from 540 k.c. to 150 m.c. at 50 ft.

Tune In "Suspense," Thursdays, 9:00 P. M., E. T., CBS

## PHONO AMPLIFIER

**?** Please design an amplifier suitable for a phonograph or tuner, and having separate channels for bass and treble. —R.R.P., Lakewood, Ohio

**A.** In the circuit shown, the first 6SN7 and the left section of the second are

used to amplify high, low, and middle tones, respectively. R1, R2, and R3 give separate control of each, as indicated. The right-hand section of the second 6SN7 is used as a cathode-follower or split-load phase inverter for the 6F6's.

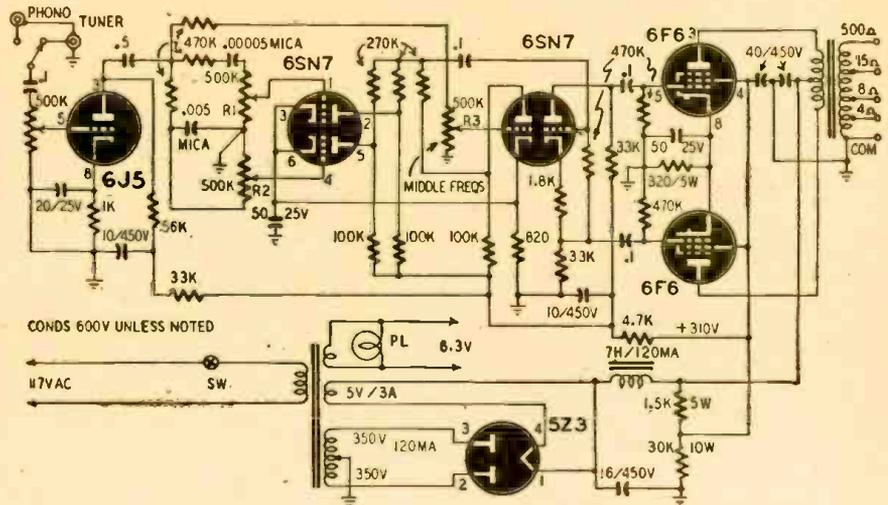

## PORTABLE G-M COUNTER

**?** Please print a circuit of a portable Geiger-Muller counter giving visual and audible indications. Headphones and a neon lamp are to be used in the indicator circuit. For more exact measurements, I want to use a 4-range meter for indicating 1, 10, 100, and 1,000 counts per second. —K.E.S., Syracuse, N. Y.

**A.** In the portable counter circuit shown, dry cells supply operating voltages for the 3A5's. A 2-volt storage battery supplies the filaments and the vibrator pack. The vibrator transformer used is a special item and may have to be wound to order. However, it may be possible to use one of the transformers designed for portable photoflash units. The Thordarson type T-22R43

delivers the necessary voltage and current in the secondary circuit. It has 117-volt a.c. and 4-volt vibrator primaries, and can be used by using a dropping resistor and operating the 3A5 filaments in series.

Adjust C1 to obtain the lowest battery drain. Its rating is approximately .0005  $\mu$ f at 2,500 volts. The G-M tube is used in a self-quenching circuit. Adjust R1 for most stable operation of the tube and set the taps on the 25,000-ohm biasing resistor for best operation of the tubes. (Additional material on G-M counters will be found in RADIO-CRAFT, February, 1944; *Electronics*, January, 1947; *Sylvania News*, May, 1947; *Electrical Counting*, by W. B. Lewis.)

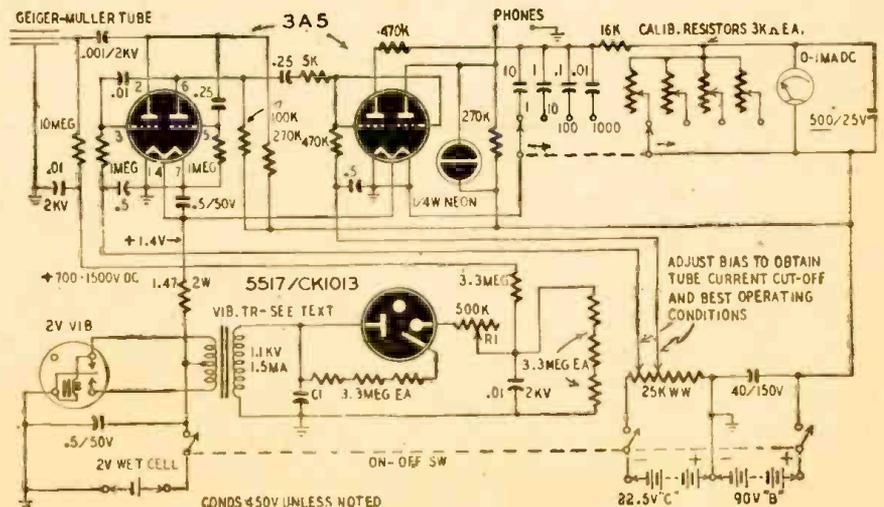

## 1-TUBE RECEIVER

**?** Please print a diagram adapting the receiver described in the August, 1947, RADIO-CRAFT, for use with one tube. —R.W.H., Atlanta, Ga.

**A.** The complete receiver, revamped for use with one tube, is shown. Make the variometer of two concentric cardboard or fiber hoops about 5 3/4 inches in

### ALL-PURPOSE MIKE

WAR SURPLUS BARGAIN

Not the "cheap" surplus variety, but the excellent Western Electric unit in a beautiful metal case. Western Electric Plug and long cord included. Ideal for home recording, public-address, etc. Very few on hand. ORDER QUICKLY!

**BRAND NEW \$1.95**

Include 26¢ for Postage

**OFFENBACH & REIMUS CO.**  
372 Ellis St. San Francisco 2, Cal.

### PE-109 32-Volt DIRECT CURRENT POWER PLANT

This power plant consists of a gasoline engine that is direct coupled to a 2000 watt 32 volt DC generator. This unit is ideal for use in locations that are not serviced by commercial power or to run many of the surplus items that require 24-32V DC for operation. The price of this power plant is only \$58.95. We can also furnish a converter that will supply 600 Watts at 110v AC from the above unit or from any 16 to 22v at 38 Amperes DC source for \$12.95. Due to the fact that the PE-109 comes to us sealed in a heavy steel-strapped govt. case, it is impossible to inspect the individual units to determine if they are new or used, or what the condition is if used. Consequently we must sell them "as is." In general they represent a terrific bargain.

**BUFFALO RADIO SUPPLY**  
219-221 GENESEE STREET, BUFFALO 3, N. Y. DEPT. 8C

### GREYLOCK

A Dependable Name in RADIO TUBES

GT, Glass, and Miniature Types

ALL TUBES IN INDIVIDUAL CARTONS

39c.	39c.	39.	49c.	49c.	59c.
6A8GT	12AT6	25L6GT	1R5	6AK5	6X4
6K7GT	12BA6	25Z6GT	1T4	6AC5	25Z5
6Q7GT	12BE3	35W4	1U4	6AQ5	6A7
6SA2GT	12K7GT	45	185	6BE6	6C6
6SK7GT	12Q7GT	46	35A	6BA6	6D6
6SD7GT	12SA7	47	3Q4	6AU6	75
6V6GT	12SK7	50B5	3V4	6BJ6	117Z3
12A8GT	12SQ7	50L6			

Webster All Pickup, plastic arm ..... \$1.49

TERMS: Net C.O.D. No order accepted for less than \$5.00

Write for Bargain Catalog C-8

**GREYLOCK ELECTRONIC SUPPLY CO.**  
30 CHURCH STREET NEW YORK 7, N. Y.

### ELEMENTS OF MAGNETIC TAPE RECORDING AND 999 APPLICATIONS

by A. C. SHANEY

Only 25c

**AMPLIFIER CORP. OF AMERICA**  
398-10 Broadway, New York 13, N. Y.

diameter, wound with six turns of No. 24 or 28 wire each. The 400- $\mu$ f tuning condensers add to the frequency range, which will be almost 10 to 1.

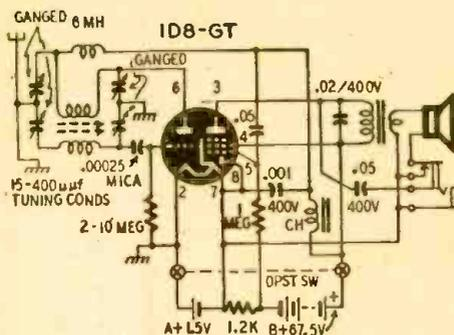

**PORTABLE AMPLIFIER**

Please give me a diagram of a portable amplifier. It should have about 6 watts output, and should operate from dry batteries or from a 6-volt vibrator supply.—E.C.B., Streamstown, Alberta

A. The amplifier diagrammed will

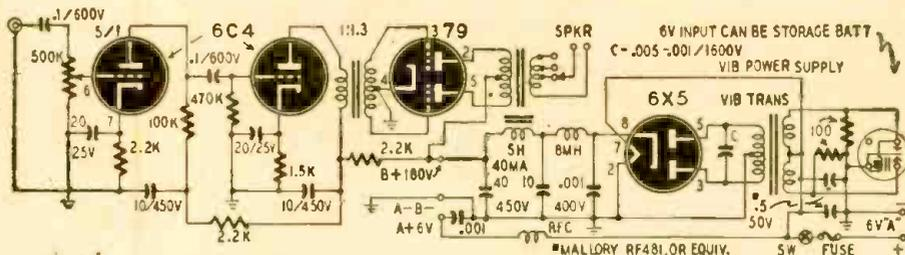

satisfy these requirements. While 2-volt tubes might require a smaller A-battery, a larger number of stages would have to be used. The 6-volt tubes have the advantage that they may be operated directly from the storage battery used to drive the vibrator supply. When using the vibrator, adjust the value of C for lowest battery drain. RFC is 55 turns of No. 12 wire close-wound on a 1-inch form.

A dynamotor giving 180 to 250 volts output at 50 ma or more from a 6-volt input could also be used. The filtering shown is more than sufficient for a dynamotor.

**1-TUBE CRYSTAL SET**

Please give a diagram for a crystal receiver using a type 30 tube for audio amplification and a selenium-rectifier power supply.—L.G., Pilot Grove, Mo.

A. Here is the circuit you requested. The rectifier is a 100-ma selenium unit. If B-voltage is too high, R may be in-

creased. L1 and L2 are not critical, since only the desired portion of each is selected by the tap. L1 might be about 30 or 40 turns and L2 around 300 turns, both on a 1- to 2-inch diameter form.

Unless an isolation transformer is used between the a.c. line and the power

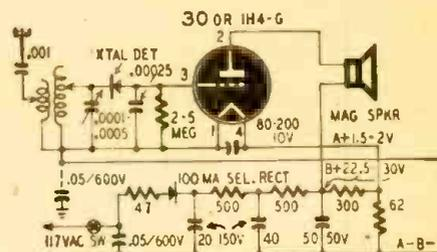

supply, be very careful about touching components. It is advisable to enclose the set in a cabinet.

**REMOTE ANTENNA**

I am about 150 miles from the nearest broadcast station and in a very noisy location. I have set up a 30-foot pole and placed a 19-foot whip antenna atop it at a spot about 300 feet from my house where noise is at a minimum. How can I run a transmission line to my receiver, picking up least possible noise along the way?—J.H.H., Inyokern, Calif.

A. The schematic shows location of the coils necessary. Wind L2 with 24 turns of No. 24 d.c.c. in a single layer on a

*Wonderful*  
**NEW 3/4 RPM Motor**  
*\$2.95*

Ideal for a beam rotor, plenty of power. Originally designed for 24 volt operation, but easily converted, 110 volts AC. Complete instructions included. Excellent for other uses too. Brand new, surplus, guaranteed. (Add 40c each to cover postage and handling)

**LAST Call!**  
**BC-454**  
used but good  
*\$3.25*

SHIPPED EXPRESS CHARGES COLLECT

**500' \$2.95**  
**3 CONDUCTOR TELEPHONE WIRE**  
3 conductor Braided insulated copper & steel telephone wire. It is made of copper for conductivity, and steel for strength. Worth at least 3c per ft. Yet due to an exceptional buy, we can now offer it at less than 1c a ft.  
Shipped Express Collect

**PHANTOM ANTENNA**  
*85¢*

A transmitting antenna, for use on approximately 450 MC. Complete with standard coax connector. A weather-proof unit. (Add 25c to cover handling and postage)

*"Meter Specials"*  
**77¢**

Brand new Bowers D.C. Volt meter 0 to 9 volts in 2" case with 2 3/4" flange each .99c

Brand new Bowers D.C. Ammeter 0 to 100 amp scales (600 ma. movement with 100 amp shunt) same case as volt meter each .99c  
Add 20c each to cover postage and handling

**IMPORTANT!**

All merchandise subject to prior sale, minimum order \$2.00. No C.O.D. orders accepted. Michigan residents must add 3% State sales tax.

**N. SILVERSTINE CO.**  
6532 EAST McNICHOLS ROAD DETROIT 12, MICHIGAN  
*"Seven Acres of Surplus"*

**NOW—A REALLY HIGH-POWERED—  
Radio Engineering  
Library**

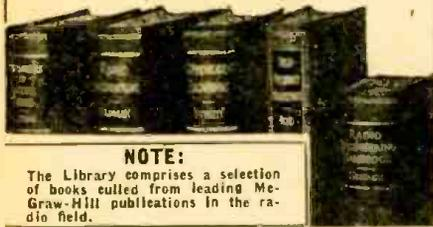

**NOTE:**

The Library comprises a selection of books culled from leading McGraw-Hill publications in the radio field.

- especially selected by radio specialists of McGraw-Hill publications
- to give most complete, dependable coverage of facts needed by all whose fields are grounded on radio fundamentals
- available at a special price and terms

THESE books cover circuit phenomena, tube theory, networks, measurements, and other subjects—give specialized treatments of all fields of practical design and application. They are books of recognized position in the literature—books you will refer to and be referred to often. If you are a practical designer, researcher or engineer in any field based on radio, you want these books for the help they give in hundreds of problems throughout the whole field of radio engineering.

- 5 VOLUMES, 3319 PAGES, 2289 ILLUSTRATIONS**
1. Eastman's FUNDAMENTALS OF VACUUM TUBES
  2. Terman's RADIO ENGINEERING
  3. Everitt's COMMUNICATION ENGINEERING
  4. Hund's HIGH FREQUENCY MEASUREMENTS
  5. Henney's RADIO ENGINEERING HANDBOOK

10 days' examination. Easy terms. Special price under this offer less than books bought separately. Add these standard works to your library now; pay small monthly installments, while you use the books.

10 DAYS' FREE EXAMINATION—SEND COUPON

McGraw-Hill Book Co., Inc. 330 W. 42nd St., N.Y.C. 18

Send me Radio Engineering Library, 5 vols., for 10 days' examination on approval. In 10 days I will send \$2.50, plus few cents postage, and \$5.00 monthly till \$27.50 is paid, or return books postpaid. (We pay postage on orders accompanied by remittance of the first installment.)

Name .....

Address .....

City and State .....

Company .....

Position .....

RC-8-48

**AUGUST SPECIAL**

**3 TUBE PHONO  
AMPLIFIER**

**\$1.95**

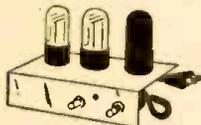

**COMPLETELY WIRED,  
VOLUME AND TONE CONTROLS**

- Set of 3 tubes: 50L6, 35Z5, 12A6.....\$1.10
- Output trans. 50L6......35
- 1/2 Meg. vol. control with sw......35
- 4" pm speaker......95
- 5" pm speaker.....1.15
- 6" pm speaker.....1.55
- 8" pm speaker.....2.75
- 12" pm speaker.....4.85
- 4 x 6" pm speaker.....1.85
- Astatic pickups.....1.89
- Astatic crystals.....1.59
- Alliance motor & turntable.....2.50
- Vm #400 intermix changer.....26.95

**FAMOUS MAKE CONDENSERS**

- 50 x 30...150v...45
- 20 x 20...150v...35
- 20x20 (10) 150v (25) 39
- 8 x 8...450v...49
- 25.....25v...29
- 25.....50v...29
- 16.....450v...39
- 400v or 600v...per 10
- .01, .02, .05...49
- .001, .002, .005...49
- .1, .3, .4, .5...59

All prices F.O.B. N.Y.C.—on C.O.D. 25% Deposit. Write for free catalog.

**THE ROSE COMPANY**

88 West Broadway, Dept. C, New York 7, N.Y.

1 1/4-inch diameter form. Over it place a strip of lead foil as a static shield. To avoid the effect of a shorted turn, insulate the ends of the shield from each other and ground the foil. Over this pie-wind L1 with 30 turns of No. 30 d.s.c. Make the pie about 1/8-inch wide. Be sure the center tap on L2 is accurately placed.

L3 and L4 are handled in the same manner. L3 is 44 turns of No. 36 close-wound, and L3 is 124 turns of the same

wire pie-wound, 1/8-inch wide. Vary the turns on L4 to allow good tracking in the receiver.

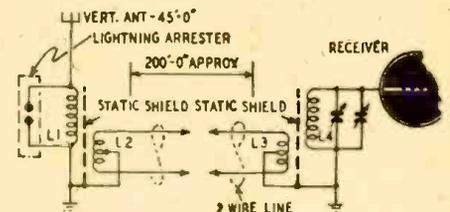

**CRYSTAL PROBE**

**?** Please print a diagram for a probe I can use with the signal tracer-injector described on page 31 of the September, 1947, RADIO-CRAFT.—E. F., Tampa, Fla.

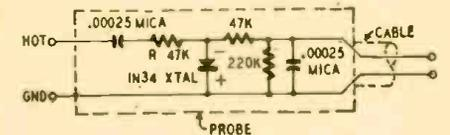

**A.** The probe shown is what you want. It uses a 1N34 crystal. It will work well with any signal tracer. Loading effect exists, but is slight.

Resistor R may be any value from

20,000 to 100,000 ohms, whichever works best for you. The probe is suitable for almost all i.f. and r.f. frequencies found in ordinary repair work.

**CRYSTAL PICKUP CABLE**

**?** Will a 10-foot cable between my crystal pickup and the amplifier cut high frequencies appreciably? — R.H., New York, N.Y.

**A.** The capacitance of the cable across the pickup will not cut highs because the crystal is itself capacitive. It may, however, reduce overall level.

**COIL DATA**

**?** I am building a superheterodyne to cover the broadcast band and 80, 40, 20, and 10 meters. I am using a 4-gang, 140-µmf tuning capacitor with 4- to 30-µmf trimmers. The i.f. is 465 kc.

Please supply me with data for winding the coils, and give values for the necessary padding capacitors. — L.I., Compton, Calif.

**A.** The coil table shows the data you require. To get all the coils to track, it may be necessary to adjust the turns or lengths slightly, as well as the padding values. Taps on

BAND (mc)	COILS	TURNS	TAP FROM GROUND END (turns)	PADDER C5 (µf)
Broadcast 0.55-1.6	L1, 3, 5	145	34	0-.00018
	L2, 4, 6	35		
	L7	115		
80 meters 3-5.7	L1, 3, 5	24	6	.0011
	L2, 4, 6	8		
	L7	21		
40 meters 5.4-10	L1, 3, 5	13	4	.0012
	L2, 4, 6	6		
	L7	12		
20 meters 9.5-18	L1, 3, 5	8	3	005
	L2, 4, 6	5		
	L7	7.5		
10 meters 15-30	L1, 3, 5	4	2	None
	L2, 4, 6	3		
	L7	4		

All coils wound on 1 1/2-inch diameter forms. All L2, 4, 6 coils spaced approx. 3/4 inch from ground ends of L1, 3, 5 coils. All wire No. 24 enameled except broadcast band coils which use No. 32. All coils close-wound except L1, 3, 5 on 80, 40, 20, and 10 meters, which are spaced to 1 inch.

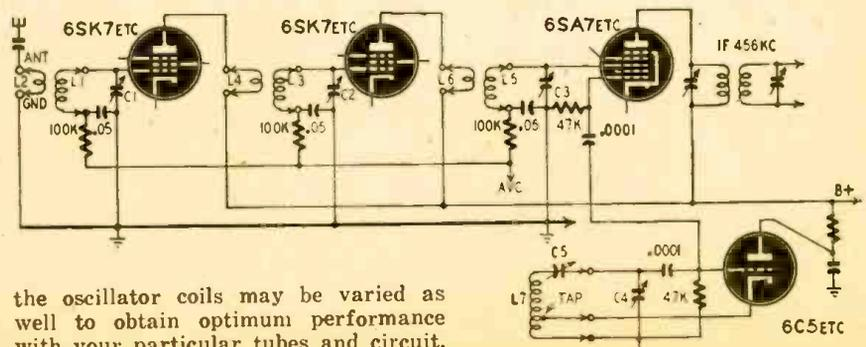

the oscillator coils may be varied as well to obtain optimum performance with your particular tubes and circuit.

# Report From Britain

By Major Ralph W. Hallows

RADIO-CRAFT EUROPEAN CORRESPONDENT

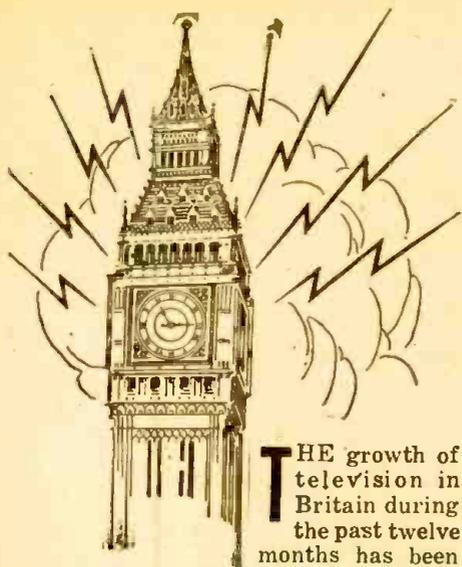

**T**HE growth of television in Britain during the past twelve months has been remarkable, especially when you consider that reception is still confined to the London area, that (owing to restricted output from the factories) televisers haven't always been easy to come by, and that many homes in some parts of London have unsuitable power supplies. British standard current is 230-volt 50-cycle a.c.; but at the moment the word "standard" is more of a pious hope than a reality. Actually you may come across a.c. with queer frequencies like 30, 40, 83 (!) and 100 cycles. In the London area you may find houses on one side of a street with d.c. at 100, 200, 205, 210, 215, 220, 230, or 240 volts and those on the other side with 100, 105, 200, 205, 210, 220, 230 or 240 volts of a.c. All this would have been ironed out before now if it hadn't been for the war. Thus by no means every home can accommodate a televiser.

In spite of that, the number of sets in use has risen from just over 18,000 a year ago to more than 45,000 now, an increase of 250 percent. It would have been much greater than that if radio manufacturers could obtain all the raw materials that they need. Meantime, work on the second television transmitter at Sutton Coldfield near Birmingham is going ahead fast. When it comes into action in the fall, television will get another big boost. If only our radio factories could get the materials, I believe that there would be half a million or more televisers in use by this time next year.

For several reasons England is probably peculiarly well situated as a country for the quick development of television. Geographically the territory is small: you can't find two places in Britain which are more than 800 miles apart; over 80% of the population can be covered by half a dozen television transmitters, each having a service area with a radius of about 40 miles; the majority of the great sporting and other events which have the biggest of all appeals to televiewers take place within easy co-ax or radio link range of these six centers. Further, there is no handicap of large time differences between the eastern and the western parts of the country. An interesting event in any

part of Britain can be televised to any other part without calling on some viewers to sit up far past their usual bedtime or on others to rise at uncanny hours if they want to see what's going on.

## Man-made static

Whatever kicks in the pants Mother Nature may deal out to radio enthusiasts in the form of static, blackouts and fading, she confines mainly to frequencies below 30 mc. Above that point the human race unhappily devises sources of man-made static which easily beat all Dame Nature's efforts on the lower frequencies. One of man's worst efforts so far has been automobile and truck ignition systems. This produces the worst kind of radio interference above about 40 mc and almost the only sort beyond 90 mc. Research has shown that this interference can easily be suppressed by a 10,000-ohm resistor in the main distributor lead. All vehicles ought to be so fitted before they leave the factory, but that hasn't come about yet, in Britain at any rate. The General Post Office, the radio trade associations, and some other concerns are having all their vehicles fitted with suppressors; but there remains one offender who is still giving a lot of trouble—the private car owner. For his special benefit a 10,000-ohm resistor gadget is sold for about 30c. A threaded tip for the distributor lead screws into a socket in the distributor. There's another type available for the "push-in" lead: Thus for a low price and little effort the private car owner can get the greater part of the advantages of complete suppression.

## High-frequency Igundering

Sometime ago Sir Edward Appleton, Director of the National Physical Laboratory, announced, as the result of a series of experiments, that it would shortly be possible to extract the dirt from soiled fabrics by the use of supersonic vibrations. Further experiments have been carried out by the Mullard Company and a recent demonstration was most striking. The instrument used is called a transducer. It converts the energy from an oscillator into pressure waves in water. Two very dirty laboratory overalls, one soaped and the other unsoaped, were put into separate tanks of water, each provided with a transducer. The unsoaped overall came out a little less white than the other, though it was perfectly clean. There is still a good deal of work to be done before the first radio-electronic laundry is opened. It has been shown that clothes can be washed without soap, but some way of whitening them has to be found. And there's a great deal to be discovered about the right frequencies for use with different fabrics. Too low a frequency means that some dirt remains; if the frequency is a good deal too high, not only is the dirt shaken out, but the fabric itself may be shaken to pieces.

## Olympic PA

An interesting PA system for the Olympic Games is being installed at the Wembley Stadium by the Philips Company. One of the difficulties about ensuring that announcements are clearly heard by members of a big crowd is that their clothes and bodies absorb the higher frequencies. Unless something is done about it the higher sound of

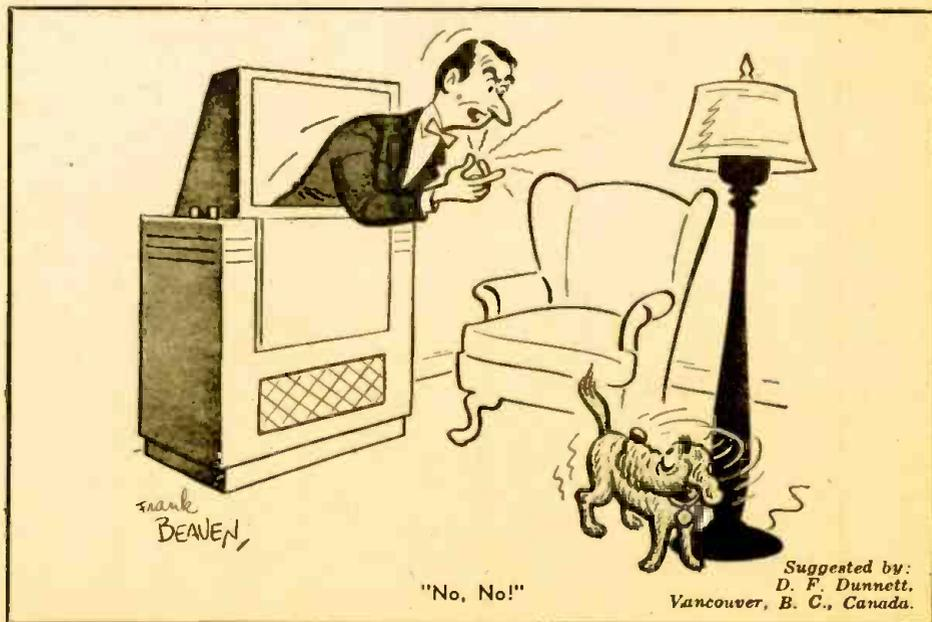

# SUMMER SPECIALS!

for TERRIFIC TUBE BUYS  
"See AMERICAN First"

Over 1,000,000 Tubes On Hand —  
Largest Stock In Country  
Other Types Available — We Invite  
Inquiries on quantity Prices

10 SPEC....	.30	368AS	7.50	826	1.45	8025	2.50	C100E	.....	.79	
10 Y.....	.49	371B	3.50	829A	2.50	9001	.....	FG105	.....	5.00	
15 E.....	.95	388A	4.25	833A	29.50	9002	.....	EF50	.....	3.50	
30 SPEC....	.75	434A	3.95	837	1.75	9003	.....	RK59	.....	5.50	
45 SPEC....	.49	450TH	12.75	841	.69	9004	.....	RK73	.....	5.75	
120	5.95	WL468	5.50	843	.69	9005	.....	RW30	.....	39.95	
123A	7.50	527	1.95	851	60.00	9006	.....	RK21	.....	1.50	
VT127A	3.95	530	29.50	CG861	40.00	1A5GT	.....	RK25	.....	3.50	
204A	25.50	531	20.00	864	.59	1A7GT	.....				
205B	3.50	575A	10.00	865	.95	1B24	2.19				
211	.79	615	.95	866	.75	1B29	.99				
215A	1.95	WL632A	5.00	876	.69	1B32	.99				
221A	1.95	703A	5.95	884	.75	1P24	.25				
222A	75.00	707B	12.50	953B	12.00	IS21	1.45	2121A	2136	2155	
242C	4.95	713A	1.25	954	.39	1R4	.99	2122	2138	4J26	
249C	1.95	714AY	8.00	955	.39	1T4	.89	2126	2139	4J28	
250TH	14.00	720CY	12.00	956	.49	1H5	.89	2132	2140	4J29	
250TL	8.00	721A	3.25	957	.39	1N5	.99	2133	2151		
256A	12.00	724A	3.95	1616	.85	2C21	.49	Any Tube Above, Ea. \$14.95			
268A	10.00	728A	10.00	1619	.49	2C22	.39	417A	.....	8.95	
274B	1.00	800	1.95	1625	.49	2C26	.25	723AB	.....	6.95	
285A	1.95	801	.75	1626	.29	2C26A	.39	725A	.....	11.95	
286A	1.95	801A	.95	1629	.29	2C40	.35	726A	.....	6.25	
304TL	1.25	802	1.25	1638	1.00	2C44	.95				
304TH	8.00	803	6.95	1641	.59	2C44	1.50				
305A	8.00	805	3.50	1665	.79	3C22	15.00				
307A	5.95	806	9.95	2050	.75	3C23	4.50				
311A	4.95	807	.95	2051	.39	3B22	3.95	905	\$ 1.75	7BP7	2.75
316A	.85	808	2.75	7193	.19	3B24	.75	2AP1	1.75	7DP4	12.95
313CD	1.95	809	1.50	8001	3.90	3C30	.65	3AP1	1.75	7EP4	17.50
331A	9.00	810	4.50	8005	2.95	2K25	15.95	3CP1	1.75	9LP7	4.95
345A	5.95	811	1.75	8011	1.50	2X2	.69	3CP1	1.75	10DP4	34.50
350	2.75	812	2.95	8012	2.95	23D4	.69	5AP1	1.75	10FP4	39.39
350A	5.75	813	5.50	8012A	3.50	28D7	1.75	5BP4	3.75	12GP7	9.95
350B	7.75	814	3.95	8013A	2.95	SD535	8.00	3DP1	2.95	12JP4	55.00
353A	1.95	815	1.95	8020	4.50	CW83	4.95	4AP10	3.50	15AP4	109.50

### KLYSTRONS AND MAGNETRONS

2121A	2136	2155
2122	2138	4J26
2126	2139	4J28
2132	2140	4J29
2133	2151	

### CATHODE RAY TUBES

905	\$ 1.75	7BP7	2.75
2AP1	1.75	7DP4	12.95
3AP1	1.75	7EP4	17.50
3CP1	1.75	9LP7	4.95
5AP1	1.75	10DP4	34.50
5BP4	3.75	10FP4	39.39
3DP1	2.95	12GP7	9.95
4AP10	3.50	12JP4	55.00
		15AP4	109.50

### RCA 2-WAY INTERCOM SYSTEM

A Special Buy Permits Us to Offer These at Low Cost—For This Month Only!



Includes: 2 stations, 1 ampli-Special Complete fier, 100 feet hookup wire. **\$22.50**

QUANTITY LIMITED  
Lots of 10 ..... **\$19.50 ea.**

### SPEAKER SPECIALS

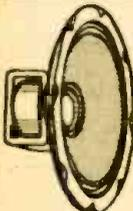

5" Permotlux Alnico PM	\$ 1.10
Lots of 10	9.50
5" Permotlux above with output	1.45
10 for 12.50	
8" Permotlux Alnico PM 1.5 oz.	1.35
Lots of 10	12.00
10" GI Alnico Heavy PM 4.7 oz.	3.95
Lots of 10	37.50
12" RCA or Magnavox PM 6.8 oz.	5.95
Lots of 10	57.50
12" Electro 1500 ohm field	5.95
Lots of 10	57.50

### PICKUP & CARTRIDGE SPECIALS

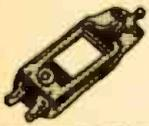

AMERICAN Crystal Cartridge replacement for All Standard Cartridges, such as A8- SPECIAL t a t t o 126-L40-L70, Shuro P87, etc. **\$125**

Lots of 10 ..... **\$10.25**

### WEBSTER

Flyweight Pickup Assembly



Special Webster Flyweight pickup with permanent needle. New type retractable cartridge. Reg. over \$10.00 list. **\$395**

Lots of 10 ..... **\$32.50**

All Merchandise Guaranteed. Your Money Back If Goods Returned Prepaid To Us in 10 Days.

Send 20% With Order. Balance C.O.D. All Prices F.O.B. New York. Minimum Order \$5.00.

### FM-AM CHASSIS ASS'Y

Famed 9-Tube HOWARD Chassis Complete with all necessary mounting hardware, antenna, 6x9" oval speaker (can take larger speaker, if desired). Complete FM coverage 88-108 Mc. **\$4995**

Lots of 10 ..... **\$45.00 ea.** WITH SPEAKER



### FARNSWORTH RECORD CHANGER

Latest Automatic Changer



Plays full stack of 10" or 12" records. Stops automatically after last record. Complete with permanent sapphire needle. QUANTITY LIMITED. Each ..... **\$24.95**  
Lots of 10 ..... Each ..... **\$21.50**  
Farnsworth changer above with GE reluctance cartridge ..... **\$26.95**

### DETROLA RECORD CHANGER

Famous Model 650



SPECIAL ..... **\$1195**

Lots of 10 ..... **\$10.50 ea.**

### SPECIAL! GI RECORDER



Single Speed Cutter and Playback 78 RPM HEAVY-DUTY MOTOR **\$15.95**

Practically for the Price of Pickup and motor Alone! Lots of 10 ..... **\$12.95 ea.**

### TRANSFORMER SPECIALS!



6.3 Volt 80 MA. Power Transformer. Highest Quality. Low Priced. Ideal for converting Surplus Equipment such as BC-348. For 6X5 rect. **\$2.25**  
700 VCT/80ma ..... **\$17.50**  
Lots of 10 ..... **\$17.50**

Univ. Output Xformer 8 watt.....	\$1.10	10/\$8.50
Univ. Output Xformer 16 watt.....	\$1.85	10/\$14.50
50L6 Output Transformer.....	.39c	Lots of 10 3.35
6V6 Output Transformer.....	.39c	Lots of 10 3.35
PP6V6/PP6L6 Output Xformers.....	.69c	10 for 5.50

speech may be so completely lost that little but a series of unintelligible "woomphs" is heard from the loudspeakers. Here's how the problem has been tackled. The 24 main loudspeakers are arranged in pairs on 12 standards. These are 25-watt 12-inch cone speakers. Immediately above each main speaker is a 12-watt high-frequency unit with a triple square-section horn. Between these and the amplifier is a bass-cut circuit. The control of both volume and frequency range is quite independent of the main loudspeakers. Thus the tonal balance can be adjusted as may be necessary to suit the size of the crowd at any time. The denser the crowd the greater the treble boost needed.

### Vest-pocket B-supply

A British battery-making company has just produced what must be about the smallest high-voltage dry battery going. Weighing 7½ ounces and measuring 3 29/32 x 2 19/32 x 2 7/64 inches, it has an output of 300 volts. It is intended primarily for photographers' repeating gas-filled flash tubes, but other ideas for its use concern radioactivity meters, insulation testers and portable television receivers. It certainly packs a punch! Connect a few of these midgets in series and you're up in the thousand volts region. Yet you could carry the lot in a pocket.

German scientists have organized the Max Planck Society for the Advancement of Science to replace the war-ruined Kaiser Wilhelm Society. The organization, named for Prof. Max Planck, who won the 1918 Nobel prize in physics, for his development of the quantum theory, held its first meeting recently in Goettingen.

Purpose of the Society is to foster free research in Germany.

New Canadian bands and modes of operation are: Eighty-meter band; A1-3.5 to 4.0 mc, A3-3.75 to 4.0 mc, FM-3.8 to 4.0 mc. Forty-meter band: A1-7.0 to 7.3 mc. Twenty-meter band: A1-14.0 to 14.4 mc, A3-14.15 to 14.35 mc, FM-14.15 to 14.25 mc. Eleven-meter band; A1-27.16 to 27.43 mc, A3-27.16 to 27.43 mc, FM-27.16 to 27.43 mc. Ten-meter band; A1-28.0 to 29.7 mc, A3 and FM-28.2 to 29.7 mc. Six-meter band; A1, A2, A3 and FM-50.0 to 54.0 mc. Canadians interested in obtaining licenses write to Room 2212, No. 3 Temporary Bldg., Ottawa, Ont., Room 403 Youville Place, Montreal, P.Q., or the nearest District Radio Office.

Canadian amateur radio operators are required to operate c.w. exclusively for a period of six months or more prior to applying for permission to operate radio-telephone stations in the 10- and 11-meter bands. After operating an active station for one year or more, they must pass an examination in advanced radiotelephone theory and operation and a 15-word-per-minute code test to qualify for an operating permit on the 80- and 20-meter bands.

# American Radio Supply Co.

120 CEDAR STREET

Phone: BArcly 7-2685-6  
WRITE — CABLE

NEW YORK 6, N. Y.

RADIO IN LATIN AMERICA

By E. A. CONKLIN

SEVERAL noteworthy radio-electronic developments are taking place in Central and South America.

In Costa Rica all radio servicemen must appear for a 3-hour oral technical examination before a Wireless and Electronics Commission, composed of three radio servicemen who have been in the servicing business for five years. Each candidate is asked 15 questions concerning circuits and servicing techniques. Passing score to obtain a servicing license is 86%. Licenses remain valid for 3 years, after which a new examination must be taken. The license costs about \$100 a year.

In Nicaragua police are using television to conduct criminal line-ups. Eleven TV transmitters have been erected in communities about 75 to 100 miles apart. Pictures of criminals caught in any of these communities are televised to other communities in the chain for identification.

In Venezuela experimentation is being carried out in the use of radio facsimile by the public. A number of offices have been set up in key Venezuelan cities and citizens may transmit messages which include drawings. At present, rates are approximately \$5.00 for a 200-word message plus 1 drawing 2 1/4 x 4 1/4 inches.

In Lima, Peru, a complete wing of a recently built hospital is devoted to electronic and radio surgery. Short-wave diathermy equipment, electronic knives for bloodless surgery, and other electronic apparatus is being used. Experimentation with ultrasonics in the treatment of tumors and cancerous growths is being performed. Under a new plan doctors in Peru will be given a 90-day course in electronics and radio as applied to surgery.

In La Paz, Bolivia, radio servicemen are being supplied with screens which can be mounted over their service benches, and slide projectors. Each month 6 slides are issued, each a blown-up schematic which the repairman can consult as he goes about his receiver analysis.

In Bogota, Colombia, automatic radio control equipment is being experimented with in helicopters. In the same city table-model television receivers are being installed in restaurants, diners, and cabarets, where, for the equivalent of 50 cents in American money, 1 hour of televised entertainment is offered. Receivers are installed in booths so only booth occupants can see and hear.

In Buenos Aires, Argentina, a new short-wave transmitter is beaming transmissions in one-hour periods to each of 16 other Latin-American countries. Each day's hourly program is devoted to news of the world, discussions on Argentinian culture, Argentinian music and drama. Multilingual announcers speak Portuguese, Spanish and other languages.

In Chile, airlines are being equipped



Now we can offer you, for the first time, the cream of articles on construction and servicing prepared by foreign technicians.

The 1948 RADIO-CRAFT REFERENCE ANNUAL brings this world-wide information, along with some of the best of our own country, in one volume. Just run your eyes down the contents listed on the right and see for yourself what a wealth of new and important material it contains. Each article has been selected with a view to presenting information not appearing elsewhere in textbooks, manuals, or periodicals printed in the United States. Each has accurate schematics and detailed data enabling you to get at constructional and operational features easily, and—if you so desire—to duplicate similar models.

Another feature of the Annual is the RADIO-CRAFT Index, covering issues between Oct. 1946 and Sept. 1947. This Index enables you to locate the important articles appearing during the year on such special subjects as come up in the course of your work or studies. Taking all in all - - the worldwide construction and servicing articles - - the handy kinks and short cuts, and the RADIO-CRAFT Index you have a well rounded reference book of inestimable value. Get this valuable 1948 reference book by subscribing to RADIO-CRAFT at once.

CONTENTS

- TRANSITRON OSCILLATOR—ITS USES
- MAKE A V.H.F. SUPERREGENERATOR
- CHECK YOUR FREQUENCY
- IDENTIFY THAT STATION
- CONSTRUCTING A B. F. O.
- TODAY'S D.-C. AUDIO AMP.
- METAL LOCATOR
- LOW-LEVEL TONE CONTROL
- PHOTO-PRINT TIMER
- SUPERSONIC DOOR OPENER
- POWER SUPPLY STABILIZER
- NEW CIRCUITS FOR OLD
- SIMPLE TUBE VOLTMETER
- 2-TUBE PORTABLE
- SIGNAL TRACER FROM OLD RECEIVER
- HI-FI TRF TUNER
- 4-TUBE REFLEX SET
- LOUDSPEAKER FIDELITY
- PHONO AMPLIFIER WITH ADJUSTABLE FEEDBACK
- MULTI-CIRCUIT CLIP SET
- A. F. EQUALIZER STAGE DESIGN
- FM RECEIVER
- NOVEL CLASS A AND B AMPLIFIER
- V.O.M.-COND. TESTER
- RADIO-CRAFT INDEX OCT.46-SEPT. 47

MAIL COUPON WITH YOUR REMITTANCE TODAY

RADIO-CRAFT  
25 West Broadway, Dept. R-C-8 New York 7, N. Y.

Gentlemen: Enter my subscription to RADIO-CRAFT for the period indicated below, and send me a free copy of the new 1948 RADIO-CRAFT REFERENCE ANNUAL. I enclose my remittance:

1 Year \$3.50                       2 Years \$6.00                       3 Years \$8.00

This is a new order                       Renewal                       Extension

Name ..... (Please print clearly)

Address .....

City ..... Zone ..... State .....

(Canadian add 50c for each year; Foreign, 75c)

with recorders so that businessmen may dictate letters as they travel. Chilean airport restaurants are now using electronic grills which can prepare sandwiches, steaks, and chops in a few seconds.

In Risbanba, Ecuador, trucks are being equipped with radar to eliminate collisions with each other in the heavy native rainstorms. Ecuadorean radio servicemen are now renting juke-boxes to private families. The radioman installs an automatic phonograph in the home and calls once a month with an assortment of 30 new records. He picks up the old records and leaves them at another home.

500 FORMULAS TO SUCCESS

MANY million dollar firms started with a single formula, for which they paid a big price. Here you have 500—no less—tried and tested formulas, recipes and processes for making things - - all at the ridiculously low price of 25c. Here is your opportunity to start a business with but a few dollars' capital and with undreamed of profits in prospect. You can also use these formulas in your own home to cut household expenses to the bone. Or you can put them to use in your workshop to cut costs as much as 1000%. Quit paying out many dollars in profits to manufacturers, wholesalers, and dealers, when you can make the same thing yourself for a few cents. It's so easy when you follow our simple instructions.

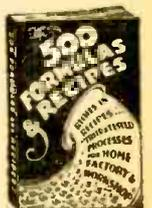

66 PAGES, 3200 WORDS IN TEXT  
Send for "500 FORMULAS AND RECIPES" today. Enclose 25c, that's all! You won't be asked for another cent now or later. Sold on a money-back guarantee.

NATIONAL PLANS COMPANY  
P. O. BOX 26 R, STATION N, New York 23, N. Y.

# SUPER VALUES from MID-AMERICA!

## Stromberg-Carlson DYNATENNA

This famous-make FM antenna has been advertised and sold for many times the low price MID-AMERICA asks! Covers both FM bands. Delivers FM reception at its best. Complete with 60 ft. of 300-ohm twin lead-in. Line is standard approved flat-type, solid dielectric with weather-resisting insulation. Mounts anywhere easily... vertically or horizontally to match polarization of trans-

mitting station. Illustrated instructions and all necessary hardware. A screw-driver is only tool needed for assembly. Dynatenna is seamless, heat-treated, all aluminum... will withstand severest weather.

**\$4.95**

each  
\$4.45 each  
In lots of 3



## PERMEABILITY TUNER

Build a really HOT 5 or 6-tube AC-DC superhet receiver! Takes place of old-style gang condenser, of antenna coils, regular 455 KC intermediate frequency. MA-2167 Complete with permeability tuned oscillator coil. \$124 4" x 2 1/2" x 2 1/2"; 2 1/4" diameter dial drum. Complete with diagrams for building 5 and 6 tube sets. Order MA-2169 Loop Antenna 15c Order MA-2914 Drilled, punched Chassis 39c



## BANTAM 1-WATTER

BCR-746-A tuning unit used as foundation for Bantam 1-Watter described in Jan. 1948 QST. Makes tiny crystal-controlled CW transmitter. Measures only 3 1/4" long, 2 1/2" high, 1 1/2" wide. Reverts only 1 1/2 volts "B". Draws 8 to 15 ma under load. Supplied less crystal, 1S4 tube and plug-in coil MA-907. **24c**

## SPECIAL AUDIO TRANSFORMERS

Exceptionally high-quality universal output transformer for up to 12" speakers. Rated at 12 watts. Matches any single, push-pull or parallel tubes to 6-8 ohm voice coil. 12" color-coded leads. 2" high with 2 1/2" mounting centers for installation on chassis or speaker. Complete with instructions for matching tube impedances. MA-1205 **\$1.19**

Hermetically sealed 200 ohm CT to 50,000 ohm grid. Use as microphone transformer, line-to-grid, etc. 2 1/2" x 1 1/2" x 1 1/2". MA-1262 **69c**

Single 3000-ohm to 4-ohm voice coil output for 60L6, 35L6, etc. 1 1/2" high on 2 1/4" mounting centers. MA-1255 **49c**

## Heavy Duty Noise Filters

Rated on 10 amps, 115-volt AC. Measures only 1" x 1 1/2" square. Install right in amplifiers, receivers and other equipment where line noises must be kept at a minimum. Nationally-known manufacturer. MA-2164 **79c**

Filter for mobile power supplies. Rated 10 amps, 6-30 VDC. Has additional 2 mfd, 100 VDC condenser. 2" high, 2" square. MA-2165 **59c**

## SPEAKER SPECIALS

All with Heavy ALNICO 5 Slugs

3 1/2" PM MA-2062 . . \$1.39 4x6 Oval PM MA-2187 \$1.39  
5" PM MA-2071 . . \$1.39 6" PM MA-2189 . . \$1.35

## ORDER FROM THIS AD!

Quantities are limited, so get your order in now! Minimum order shipped \$2.50. Send 25% deposit, balance C. O. D. Get on MID-AMERICA'S mailing list to receive BIG BARGAIN BULLETINS that list latest, greatest buys in radio parts, electronic equipment. Send orders to Desk RC-88.

**MID-AMERICA CO. Inc.**

2412 S. Michigan Avenue  
Chicago 16, Ill.

# A. F. C. STOPS DRIFT

*It can be added to existing radios.*

By L. S. WECKER

MOST FM and television set owners soon realize that these units are much more difficult to tune than the broadcast sets to which they have become accustomed. Many of these sets must be *retuned* (at least once) during the warm-up period because of drift in the oscillator and other tuned circuits.

Some manufacturers have made tuning easier by using slow-motion dial drives and tuning indicators. Attempts have been made to stabilize receivers completely by using temperature-compensating capacitors and regulated voltages in the oscillator circuit.

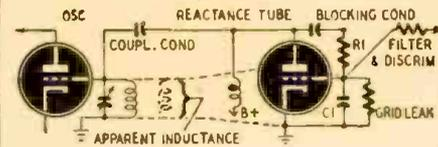

Fig. 1—This circuit adds apparent inductance.

These measures are, in most instances, but a partial solution to the problem. Automatic frequency control (a.f.c.) can be added to the average FM or television set to compensate further for drift and to make tuning simpler. This addition costs little and is easy to make.

An a.f.c. circuit consists of a controlled oscillator, a discriminator, and a reactance modulator or reactance tube as they are called in control circuits. Since almost all FM and television sets have an oscillator and discriminator, a.f.c. can be added to them simply by installing a reactance coil tube.

## How reactance tubes work

In FM transmitters and signal generators, a reactance tube shifts the oscillator frequency in response to modulation. In a.f.c. circuits, the oscillator is shifted to its correct operating fre-

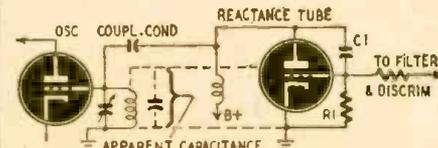

Fig. 2—Here the reactance tube is capacitive.

quency whenever the receiver or transmitter drifts.

When a reactance tube is connected across a tuned oscillator circuit, it can be made to appear as added inductance or capacitance by causing its grid voltage to lag or lead the oscillator tank voltage by 90 degrees.

Fig. 1 is the circuit of an inductive-reactance circuit. The reactance tube is connected to the oscillator through a coupling condenser with low reactance at radio frequencies. Grid voltage for the reactance tube is taken from a point

on a phase-shifter network consisting of R1-C1. The resistance of R1 is much larger than the reactance of C1. The reactance of the blocking condenser is so low, and the grid-leak resistance so high, that neither affects the phase-shift network. The current through this network is in phase with the r.f. tank voltage. Since voltage lags current 90 degrees through a capacitor, the grid voltage lags the tank voltage by 90 degrees. In a vacuum tube the plate current is rising and falling with the grid voltage, so the plate current is lagging the r.f. tank voltage by 90 degrees. This lagging plate current is drawn through the tank circuit, giving the effect that an inductive reactance has been connected in parallel with it. This produces an increase in the resonant frequency of the oscillator.

In a capacitive-reactance circuit (Fig. 2) the positions of C1 and R1 have been reversed and the reactance of C1 is much larger than the resistance of R1. In this circuit, the grid voltage leads the tank voltage by 90 degrees and produces a plate current leading the tank voltage by an equal phase angle.

The magnitude of the apparent reactance is controlled by the d.c. bias on the

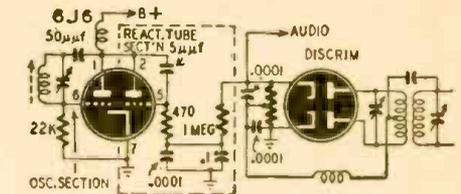

Fig. 3—Diagram shows complete a.f.c. circuit.

grid of the reactance modulator. This control bias is developed by a discriminator in a.f.c. circuits.

The discriminator converts frequency variations into voltage variations. When we tune it to the center frequency of a carrier, no voltage is developed across its output. However, should we move the carrier higher or lower, we would get either a negative or a positive voltage developed across the output of the discriminator. By the same token should the local oscillator, i.f. amplifiers, or the transmitter deviate from mean center frequency, the discriminator develops a negative or positive voltage that can be filtered and used to bias the reactance tube grid.

## A.F.C. for FM or TV receivers

Fig. 3 is the circuit of an a.f.c. circuit that can be added to many existing FM and television sets. A 6J6 is shown as a combination oscillator and reactance tube. In sets using a separate triode oscillator, the oscillator socket can be rewired to take a double triode such as a 7F8 or 6J6. One triode is wired into



the oscillator circuit and the other used as the reactance tube. When a single tube is used as oscillator and mixer, an additional socket can be mounted for the reactance tube. A 6C4 is a good choice since it shouldn't be hard to find space near the oscillator to mount it in almost any receiver.

Control voltage is taken from the a.f. output circuit of the discriminator and passed through a filter network consisting of a 1-megohm resistor and .0001- and 0.1- $\mu$ f condensers. This filter removes a.f. and residual r.f. voltages. The r.f. choke in the plate lead prevents r.f. voltages from flowing through the power supply. This may be a standard v.h.f. choke or may be about 28 turns of No. 24 enameled wire close-wound on a 1/4-inch form.

**MULTI-ELEMENT FM TUBE**

**L**IMITING and detection of FM signals in a single tube is made possible by a recent development by Dr. Robert Adler of Zenith Radio Corporation. The new tube, simple, though unconventional in design, does the dual job with the aid of only one tuned circuit and without any problems of critical transformer coupling.

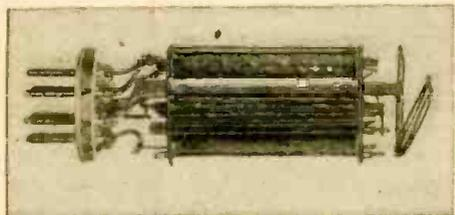

Structure of the new FM limiter-detector tube.

The diagram shows the tube schematically. Electrons emitted by the rectangular cathode are focused into a narrow beam by the lower focusing electrode which is connected to cathode. The beam passes through the slit in the lower accelerator, to which a positive potential is applied.

When the limiter grid is at a certain minimum negative potential, it turns back few electrons, allowing most of them to pass through it, through the slit in the upper accelerator, and on to the quadrature grid and plate. When the grid potential is somewhat more negative, it turns back a few of the electrons; in an ordinary tube, this would merely result in a proportional reduction in plate current. However, in this tube, the turned-back electrons upset the

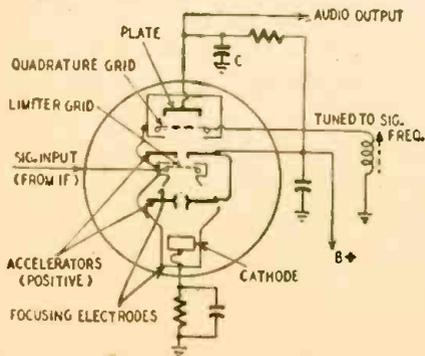

Schematic diagram shows how the tube is made.

**EVERY SERVICEMAN  
CAN afford  
SUPERIOR  
TEST EQUIPMENT**

The New Model 670

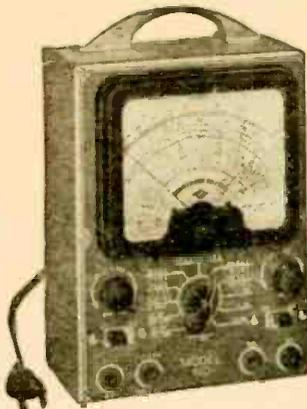

**SUPER METER**

A Combination VOLT-OHM-MILLIAMMETER plus CAPACITY REACTANCE, INDUCTANCE and DECIBEL MEASUREMENTS

D.C. VOLTS: 0 to 7.5/15/75/150/750/1500/7500. A.C. VOLTS: 0 to 15/30/150/300/1500/3000 Volts. OUTPUT VOLTS: 0 to 15/30/150/300/1500/3000. D.C. CURRENT: 0 to 1.5/15/150 Ma.; 0 to 1.5 Amps. RESISTANCE: 0 to 500/100,000 ohms, 0 to 10 Megohms. CAPACITY: .001 to .2 Mfd., .1 to 4 Mfd. (Quality test for electrolytics). REACTANCE: 700 to 27,000 Ohms; 13,000 Ohms to 3 Megohms. INDUCTANCE: 1.75 to 70 Henries; 35 to 8,000 Henries. DECIBELS: -10 to +18, +10, to +38, +30 to +58.

The model 670 comes housed in a rugged, crackle-finished steel cabinet complete with test leads and operating instructions. Size 5 1/2" x 7 1/2" x 3". **\$28.40** NET

We manufacture a complete line of radio test equipment. Write Dept. RC for FREE catalog today!

MFD. BY



**SUPERIOR INSTRUMENT CO.**

227 Fulton St., New York 7, N. Y.

at your regular jobber

**ACORN says:  
COMPARE these PRICES!**

**JENSEN 10" PM SPEAKER**

Alnico V Magnet  
Jensen "Standard Series" PIOT ST 110. An excellent speaker for good quality radio sets or PA systems. Output undistorted 8 watts. Voice coil impedance 6-8 ohms. A great value at \$4.69

**UNIVERSAL POWER TRANSFORMER**

Primary 115v 60 cycles  
Secondary 720v c.t. at 150 mils  
6.3v at 3 amps  
5.0v at 3 amps  
Half shell mtg with mtg centers 2 1/2 by 3 1/4  
Size 3 3/4" x 3 1/8" Only \$3.49—3 for \$10.00

**POWER TRANSFORMER**

PRIMARY 115 volts 60 cycles  
SECONDARY 600v c.t. at 100 mils  
4.3 v at 3 amps; 5 v at 2 amps half-shell mtg.  
Mtg. centers 2 5/16" x 2 3/4"  
Made by Thordarson. Shipping wt. 5 lbs.  
Now \$2.89—3 for \$8.25

**HAMMURLAND MIDGET CAPACITORS "MC"**

MC 250 260mfd. \$ .69 ea. 10 for \$6.50  
MC 325 320mfd. .79 ea. 10 for 7.50

ELECTROLYTIC CONDENSERS		OIL CONDENSERS	
FP TYPE IN CANS		2 x .02 mfd 1500v	\$ .69
10 @ 350v	} .39	.1 mfd 3500v	.79
30 @ 300v		.1 mfd 7500v	1.79
20-20 @ 25v		.25 mfd 3000v	1.19
30 @ 450v	} .99	.15 mfd 4000v	1.39
20 @ 450v		.5 mfd 5000v	1.89
10 @ 450v	} .74	1.0 mfd 2000v	1.29
20 @ 25v		1.0 mfd 1200v	.99
20-20 @ 450v	} 1.29	4.0 mfd 1000v	.89
20-20-20 @ 450v		4.0 mfd 600v	.45
20-20 @ 400v-250v	} .44	3+3 mfd 600v	.79
10-10 @ 350v		6.0 mfd 600v	.79
20 @ 25v	} .59	8+1 mfd 1000v	1.39
30-30 @ 450v		10 mfd 600v	.89
100 @ 50v	} .49	15 mfd 1000v	1.89
1000 @ 25v		1.0 mfd 330vAC/1000DC	.39
10-10-10-10 @ 400v	} .59	1.5 mfd 333vAC/1000DC	.39
BATHUB CONDENSERS		TLA OIL FILLED	
2.0 Mfd 600v with side terminals	.44c ea.	4.0 mfd 600v	1.49
10 for \$3.90		2.0 mfd 1000v	1.39

Terms: 20% Cash with order. Balance C.O.D. Prices F.O.B. N.Y. Minimum order \$2.50.

**ACORN ELECTRONICS CORP.**

80 Vesey St. Dept. C N. Y. 7, N. Y.

Miller BUILDERS OF QUALITY RADIO INDUCTANCES SINCE 1924

**NOW AVAILABLE TO THE SERVICEMAN AND EXPERIMENTER THE FAMOUS**

**K-TRAN**

- THE FINEST MINIATURE I. F. TRANSFORMER EVER MANUFACTURED!
- ONLY 2 1/4" HIGH BY 3/4" SQUARE



- SHELL CORE PERMEABILITY TUNED. STABLE SILVER MICA FIXED CONDENSERS — NOT MICA COMPRESSION TUNED.
  - UNIQUE SNAP CLIP MOUNTING FOR ROUND HOLES IN CHASSIS.
- 455 KC input transformer gain 50. Band width at 2 times 16 KC; at 10 times 40 KC.  
455 KC output transformer gain 110. Band width at 2 times 18 KC; at 10 times 50 KC.  
262 KC input transformer gain 65. Band width at 2 times 9 KC; at 10 times 23 KC.  
262 KC output transformer gain 130. Band width at 2 times 10 KC; at 10 times 27 KC.

CAT. No	ITEM	NET PRICE
12.H1	262 KC Input I. F. Trans.	\$1.35
12.H2	262 KC Output I. F. Trans.	1.35
12.C1	455 KC Input I. F. Trans.	1.30
12.C2	455 KC Output I. F. Trans.	1.20

The "K-TRAN" is distributed nationally to the jobber only by J. W. Miller Company.

\*Manufactured under "K. TRANS" Patent Numbers 2435630 and 2429468 of Automatic Manufacturing Corp.



**J. W. MILLER COMPANY**  
5917 S. MAIN ST. LOS ANGELES, CALIF.

Mr. Radio Serviceman

## ADDITIONAL \$\$\$\$ FOR YOU EVERY WEEK REPAIR ELECTRICAL APPLIANCES



The Model 40 Utility Tester comes housed in a rugged crackle finished steel cabinet with portable cover, complete with all test leads and operating instructions—only .....

**\$15.75**

WITH THE AID OF THE NEW MODEL 40

### UTILITY TESTER

A NEW KIND OF INSTRUMENT FOR TESTING ALL ELECTRICAL CIRCUITS AND APPLIANCES SUCH AS—

\*RANGES \*WASHERS \*VACUUM CLEANERS  
\*SHAVERS \*FANS \*AIR CONDITIONERS  
\*HEATERS \*MOTORS \*REFRIGERATORS  
\*IRONERS \*TOASTERS \*SUN LAMPS  
\*WASHING MACHINES \*ALL TYPE MOTORS FROM FRACTIONAL H.P. TO 2 H.P.

#### THE MODEL 40 UTILITY TESTER

Will test Thermostats under ACTUAL WORKING CONDITIONS: Will measure the ACTUAL CURRENT CONSUMPTION of any appliance either A.C. or D. C. WHILE THE UNIT IS IN OPERATION—reading will be direct in amperes—the appliance or utility may be plugged directly into front panel receptacle—a special pair of insulated clip-end leads is provided for motors; Incorporates an ultra-sensitive direct-reading resistance range which will accurately measure all appliance and utility resistances down to a fraction of an ohm; Will test bulbs, fuses, condensers, field coils, etc.; Is ideal trouble shooter as it will instantly locate opens, shorts and grounds; Will locate cause of failure in three way heat control switches; will indicate when one side of an appliance or motor connected to line under test is "grounded"; Will indicate excessive leakage between a motor and a line; Will indicate when a three phase motor is running erratically due to a "blown" fuse; Will indicate whether the voltage is 110 Volts or 220 Volts, if the current is A.C. or D.C. and if the frequency is 25 cycles or 60 cycles.

**GENERAL ELECTRIC DISTRIBUTING CO.** 98 PARK PLACE, Dept. R.C.-8  
NEW YORK 7, N. Y.

space charges which allow the beam to pass through the lower accelerator slit. The beam is diffused and many electrons are absorbed by the accelerator. As a result, plate current reduction is very great. With a slightly more negative grid, plate current drops abruptly almost to zero.

The difference in grid voltage required to produce maximum and minimum plate current is very small, since negative grid signals not only limit plate current in the usual manner, but also limit it further by diffusing the beam. As long as the input signal exceeds about 1 volt, a square-wave output is obtained, making any amplitude variations in the input signal ineffective.

Detection is obtained by means of the quadrature grid. This is connected to ground through a tuned circuit which is adjusted to the center frequency of the input signal. The quadrature grid obtains its signals from the electron stream; it then affects the space charge surrounding it. The effect with no audio modulation is exactly 90 degrees out of phase with the input signal. The two 90-degree-out-of-phase or quadrature signals both reach the plate, interacting to produce an output of a certain fixed amplitude.

When the signal is modulated, the frequency swings away from its unmodulated value, at an audio rate. Since at most instants the modulated signal frequency is different from that to which the quadrature grid circuit is tuned, the phase difference is usually not 90 degrees. Therefore, the plate current, which is dependent on the mixture of the phased signals, varies along with the phase difference. Since the phase difference depends at any instant on the a.f. modulation, so does the plate current. Capacitor C filters out the r.f. from the plate circuit and audio is produced across the plate resistor.

The new tube does the work of three or four separate tube sections in the standard FM receiver circuit—one or two limiters and two discriminator diodes. The smaller requirements for parts and tubes will allow important production economies.

### COMMERCIAL FACSIMILE

Facsimile Broadcasting on a commercial basis was authorized by FCC to take effect on July 15th. Operation previously has been experimental.

The authorization allows facsimile to be transmitted over standard FM stations by either the simplex or the multiplex method. With simplex transmission, the entire channel is devoted to facsimile while pictures are being transmitted. With multiplex, the regular aural programs are transmitted at the same time as the facsimile.

To avoid interruption of sound-program service, the Commission has limited simplex operation to 1 hour between 7 am and midnight. Multiplex is permitted for a maximum of 3 hours per day between 7 am and midnight. Use of either system between midnight and 7 am is unlimited.

RADIO-CRAFT For

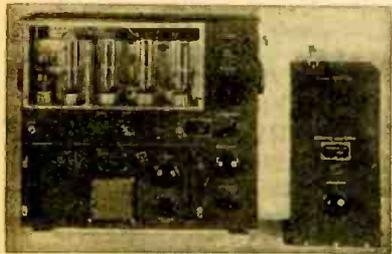

## GENERAL ELECTRIC 150 WATT TRANSMITTER

Cost the Government \$1800.00

Cost to you \$44.50!!!!

This is the famous transmitter used in U.S. Army bombers and ground stations, during the war. Its design and construction have been proved in service, under all kinds of conditions, all over the world. The entire frequency range is covered by means of Plug-In tuning units which are included. Each tuning unit has its own oscillator and power amplifier designed to operate at top efficiency within its particular frequency range. Transmitter and accessories are finished in black crackle, and the milliammeter, voltmeter, and RF ammeter are mounted on the front panel. Originally designed to cover the frequency range from 200 to 500 KC and 1500 to 12,500 KC. Will operate on 10 and 20 Meter Bands with slight modification. Here are the specifications: OSCILLATOR: Self-excited, thermo compensated, and hand calibrated. POWER AMPLIFIER: Neutralized class "C" stage, using 211 tube, and equipped with antenna coupling circuit which matches practically any length antenna. MODULATOR: Class "B"—uses two 211 tubes. POWER SUPPLY: Supplied complete with either 12 or 24V dynamotor (SPECIFY), which furnishes 1000V at 350 MA. Complete conversion instructions for 10 and 20 Meter bands as well as 110V AC modifications are furnished. SIZE: 21 1/2 x 23 x 9 1/4 inches. Total shipping weight 200 lbs., complete with all tubes, dynamotor power supply, five tuning units, antenna tuning unit and the essential plugs. These units have been removed from unused aircraft but are guaranteed to be in perfect condition.

**BUFFALO RADIO SUPPLY**

219-221 GENESEE STREET  
BUFFALO 3, N. Y. DEPT. 8C

## EASY TO LEARN CODE

It is easy to learn or increase speed with an Instructograph Code Teacher. Affords the quickest and most practical method yet developed. For beginners or advanced students. Available tapes from beginner's alphabet to typical messages on all subjects. Speed range 5 to 40 WPM. Always ready—no QRM.

**ENDORSED BY THOUSANDS!**

The Instructograph Code Teacher literally takes the place of an operator-instructor and enables anyone to learn and master code without further assistance. Thousands of successful operators have "acquired the code" with the Instructograph System. Write today for convenient rental and purchase plans.

**INSTRUCTOGRAPH COMPANY**

4701 Sheridan Rd., Dept. RC, Chicago 40, Ill.

## LEARN RADIO — ELECTRONICS FOR ONLY \$5 FOR THE COMPLETE 972-PAGE TRAINING



FOR BEGINNERS  
36 COURSES IN ONE

and was more widely used for Signal Corps, etc. wartime training than any other of its kind!

**READ IT 5 DAYS—AT OUR RISK**

Send \$5 (\$5.50 foreign) cash or money order for RADIO PHYSICS COURSE, or we will send book C.O.D. (in U.S.A. only). You can then pay postman this amount plus a few cent postage when book arrives. IF YOU ARE NOT MORE THAN SATISFIED, return book to us within 5 days and your \$5 will be refunded promptly.

RC-88, MURRAY HILL BOOKS, INC., 232 Madison Ave., NEW YORK 16, N. Y.

**TV ANTENNA**

Patent No. 2,440,597

Horace Atwood, Jr., Bellville, N. J.

(assigned to Du Mont Laboratories, Inc.)

This antenna is especially suitable for indoor use, as in an attic. It is effective over a wide frequency band and can be coupled to a low-impedance line.

A metal foil or plated surface covers the area of the two cones which are of hard insulating material. The conducting surface connects to metal rings near the middle of the antenna. The transmission line is soldered to the rings as shown.

A wooden rod through the antenna axis gives the unit a firm support. Its ends may be suspended or supported in any manner.

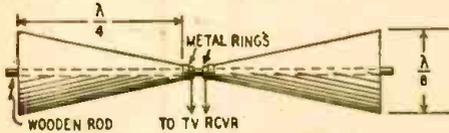

**R-C OSCILLATOR**

Patent No. 2,439,245

James C. Dunn, Philadelphia, Pa.

(assigned to Philco Corp.)

One form of an improved audio oscillator which is capable of good wave form and wide frequency range is shown in the accompanying figure. It uses only one tuning control, a variable resistor.

The invention consists of a 2-tube amplifier with the second tube coupled to the first through a bridged-T network. Negative feedback takes place through the fixed resistor in this network, and regeneration is obtained through the variable resistor.

As the T network is adjusted, there is one frequency which is balanced out. This frequency depends upon the R and C values of the network. At this frequency there will be almost no negative feedback to the 7W7 cathode, and therefore the circuit oscillates. The 100-ohm resistor in the grid circuit of the first tube is the regeneration control. It is set at the lowest value which will permit oscillation.

The component values given are for a frequency range of approximately 2-20 kc. The capacitors may be changed to give other frequencies.

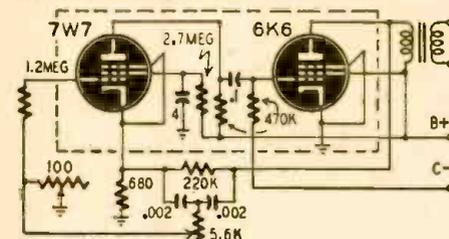

**MAGNITUDE AND PHASE CONTROL**

Patent No. 2,441,334

William H. Sayer, Passaic, N. J.

(assigned to Du Mont Laboratories, Inc.)

Only a positive pulse can trigger a thyatron. This circuit can reverse the polarity of a signal so an input pulse of either polarity can be used if its magnitude is great enough.

The middle of the plate load resistor is grounded. Therefore voltage polarity is different on each side. Furthermore the value of this potential increases as P is moved away from ground. The contact is set at the point which provides enough positive voltage to operate the thyatron.

The figure shows how the circuit may be used ahead of an 884 or similar tube to generate saw-tooth waves. If the input signal is positive P is moved towards the cathode end of the potentiometer.

The capacitor-selector switch chooses the capacitor which will give the time-constant desired for the saw-tooth wave generated by the thyatron.

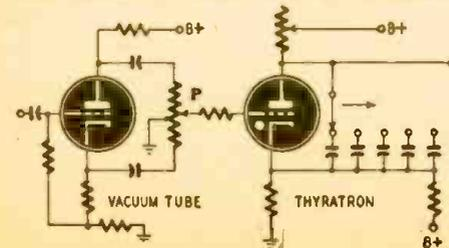

**HOT SUMMER SPECIALS**

**COMMAND RECEIVERS**

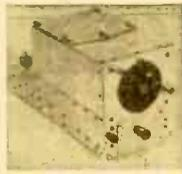

BC-946 520- to 1500 KC with Schematic. **\$18.95**

New BC-454 3 to 6 Mc. with Schematic. **\$5.95**

BC-455 6 to 9.1 Mc. with Schematic. **\$7.95**

DUAL RECEIVER RACK—New \$1.00  
TUNING CONTROL CRANK .50

TRANSFORMER FOR RECEIVERS—115 Volt. 60 cycle Primary; Sec. 250-0-250 Volt 50 MA. **\$2.95**  
6.3 Volt and 24 Volt. with AC Schematic.

BC 456 MODULATOR for Comm. Trans. with Schematic—New **\$2.50**

**INTERPHONE AMPLIFIER BC-347**

Army Aircraft Type: Uses 6F8 Tube. Contains two (2) Midset High Fidelity CTC output transformers (1 1/2" x 1 1/2"). Input 200 ohm to single or push-pull Grid; Output 200 ohm from single or push-pull plate, plus resistors, cond., etc. Completely enclosed. With Schematic. Size: 2 1/2" x 4" x 8". Less Tube. **\$2.00**  
price—each—New .79c  
Or three (3) for



250 OHM HEADSET—Can be used with above as Mic. & Rec. HS-30—NEW **97c**

**SPECIAL OFFER**

TUBE CONVERSION CHART—VT to Commercial—furnished at no charge with your Order.

MINIMUM ORDER—\$2.00 • Prices F.O.B., Lima, Ohio • 25% DEPOSIT On C.O.D. Orders

**LOOP LP-21**

**RADIO COMPASS INDICATOR ANTENNA**



Can be used for small beam rotator. Loop rotated by selsyn motor. also has selsyn indicator trans. for remote indication. Slip ring assy (S). Contacts and rings made of silver. Loop is enclosed in tear drop housing. Wiring diagram for AC operation is included. Used, but Tested. **\$3.95**

**SELSYN INDICATOR AND MOTOR**

Part of LP-21 Loop. 0-360 calibration on selsyn. Wiring Schematic Included. Used (Tested) **\$2.95**



**1-82 5" INDICATOR**



Radio Compass indicator used with selsyn for remote indication (Used and Tested) at **\$2.95**  
New **\$4.95**

**SELSYN 2JIG1**

Suggested wiring for 110 volt. 60 cycle included. Normally operates from 57 1/2 volts. 400 cycle. Used (Tested) Per Pair—**\$3.50**  
only



**DYNAMOTORS**



MOBILE USE—9 Volt input; output 405 volts 95 MA. Also will operate from 6 Volt input; output 280 Volts 95 MA. Size: 3" x 7". DM 635x **\$3.95**

**FAIR RADIO SALES**

132 SOUTH MAIN ST. LIMA, OHIO

**HOW TO GET THE MOST from only BASIC TEST EQUIPMENT**

**Servicing by Signal Substitution**

The Simple, Modern, Dynamic Speed approach to receiver alignment and adjustment problems, FM-AM-TV.

- Nothing complex to learn
- No extra equipment to purchase
- Universal — non-obsolete
- Employs only Basic Test Equipment

**S-S-S tells HOW — in simple, direct language.**

New 9th edition now off the press. 100 pages of valuable information.

Available from all leading radio parts and equipment distributors or directly from factory at only 40c per copy.

PRECISION APPARATUS COMPANY, Inc. • 92-27 Horace Harding Blvd., Elmhurst 4, N. Y.

**TERRIFIC VALUE—PORTABLE ELECTRIC DRILL**



(Sold at less than established factory price so we cannot mention brand name)

Only \$19.95 equipped with 1/2" Jacobs Geared Chuck and Key.

Not an intermittent duty drill, but a full size rugged tool.

Most convenient type switch, natural grip handle, and balance like a six-shooter.

Precision cut gears—turbine type cooling blower—extra long brushes.

No stalling under heaviest pressure because of powerful 110 Volt AC-DC motor and multiple ball thrust bearing.

Other bearings self-aligning lifetime-lubricating Chrysler Onite type.

Made for toughest year-in and year-out service in Plant or on construction jobs.

Amazing perpetual factory guarantee assures you of a lifetime of trouble-free use.

25% deposit on C.O.D.'s. Full refund (you pay transportation) if not pleased with drill after trial.

**BUFFALO RADIO SUPPLY**

219-221 GENESEE STREET

BUFFALO 3, N. Y.

DEPT. 8C

# TRANSVISION

## BIGGEST VALUES in TELEVISION!

Large-Image, Direct-View TV Kits at Low Cost!

Kits Engineered for EASE of ASSEMBLY and Top Performance. Cabinets designed and built for Beauty, Utility, Durability.

**NO TECHNICAL KNOWLEDGE REQUIRED FOR ASSEMBLY.**



Console Model 7CL

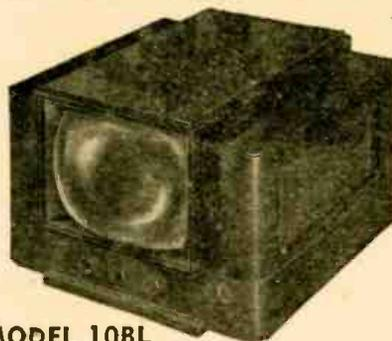

MODEL 10BL  
Gives 115 Sq. In. Picture

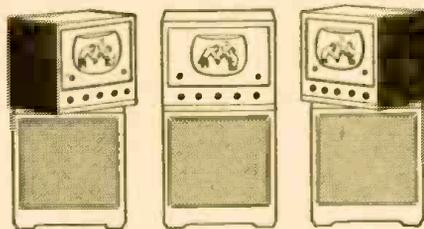

Roto-Table for full 180° Visibility

TRANSVISION manufactures the most extensive line of high quality Television Kits, Cabinets, and Components. Models illustrated and listed here are only representative of Transvision's leading values. See your distributor.



MODEL 10BL, TV/FM Kit, gives 115 sq. in. picture; complete FM Radio; receives all channels; streamlined cabinet . . . NET \$299.00  
Roto-Table for Model 10BL, gives full 180° visibility. . . NET \$ 24.95  
MODEL 7CL, TV Kit, gives 60 sq. in. picture; console cabinet with Roto-Table; streamlined design . . . NET \$199.00  
MODEL 7BL, same as 7CL except that it is a table model NET \$189.00  
All prices include cabinets, tubes, antenna, and 60 ft. of lead-in wire. (Models 7CL and 7BL can be supplied with complete FM Radio for small additional cost.)

**—FREE—**  
**Fascinating**  
**BOOKLET**  
**On Television**

Illustrated 20-page 2-color booklet gives you excellent basic information on television. Call at your distributor's for a FREE COPY; or write to us for names of distributors.

### "SERVICE NOTES"

by TRANSVISION

the Key to Successful Television Servicing . . . Confidential Television Notes and Information, product of experience with over 20,000 television sets. Complete with photos, diagrams. Worth a small fortune. Cost is only \$1.95 NET



All prices 5% higher west of Mississippi; all prices fair traded. For further information see your distributor, or write to:

**TRANSVISION, INC. Dept. R.C. NEW ROCHELLE, N. Y.**  
*In Calif.:* Transvision of California, 8572 Santa Monica Blvd., Hollywood 46

## BIG TELEVISION SHOW at the WALDORF!

On August 16, 17, and 18. Transvision will hold its 2nd annual exhibit at the Waldorf-Astoria Hotel in New York . . . BE SURE TO COME and see the many sensational new television developments.

### NOISE REJECTOR

Patent No. 2,438,501

Donald L. Hings, Ottawa, Ont., Canada.  
(assigned to Electronic Lab., Inc.)

The inventor of this circuit claims that many types of noise are practically eliminated by it. The noise is amplified separately and then mixed with the incoming signal in a pentagrid tube. If the noise level is adjusted correctly, it will oppose the noise in the signal. The result is cancellation of noise without affecting the desired signal.

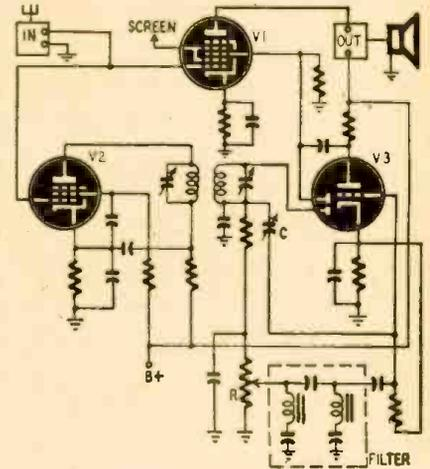

The signal is applied to the control grids of V1 and V2. The amplified signal (including the noise) is transmitted through the transformer to one diode plate of V3. Here it is rectified, and part of it passes through C to the control grid. The remainder of the r.f. component is filtered out while the a.f. component appears at R. This is followed by a high-pass filter with cutoff at about 3 kc. These higher frequencies passed by the filter (shown in the dashed box) include most of the noise.

The noise is amplified in V3 and then applied to the grid No. 3 of V1. The noise voltage opposes the signal voltage at grid No. 1. The control R is adjusted for the proper level to produce noise cancellation.

### VOLTAGE MULTIPLIER

Patent No. 2,439,224

Winfield R. Koch, Haddonfield, N. J.  
(assigned to Radio Corp. of America)

A potential of 25 kv or more must be used for projecting large-screen television. This voltage may be obtained by rectifying the pulses from the scanning circuit and then doubling or tripling as required. The ordinary type of voltage-multiplier is not satisfactory because it uses several condensers in series to bring up the total voltage. Regulation is poor when a series circuit is used. The circuit shown here is a voltage-tripler in a parallel arrangement. Each rectifier is supplied by its own condenser. Regulation is greatly improved.

Each rectifier must be connected with polarity as shown, since the input is not symmetrical. C1 becomes charged to the peak voltage E, and during the next few pulses the charge leaks off and places a voltage E upon C2. During each pulse, V2 is subjected to a voltage 2E, the sum of the potential upon C2 and the pulse voltage.

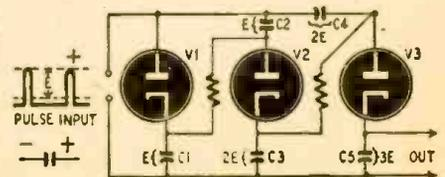

Therefore C3 becomes charged to a voltage 2E. During the next few pulses this voltage appears across C4 because of the leakage current. V3 is now subjected to a potential 3E, made up of the voltage across C4 in series with the input. Therefore a voltage 3E appears across C5. Output is taken from this point.

Additional stages may be added for still higher voltages. The output remains fairly constant even when the load changes.

**SQUARE WAVE GENERATOR**

Patent No. 2,440,992

Richard C. Webb, LaFayette, Ind.

(assigned to Purdue Research Foundation)

A good square wave generator needs two main controls: pulse width and frequency. Neither should have much effect on the other. These requirements are met in this simple generator. It uses a double-triode tube, such as a 6SN7, and a triode cathode follower.

When power is first turned on, C1 is uncharged so grid G1 is at ground potential. G2 is at high positive potential because it connects to B plus through a condenser. The heavy plate current through T2 produces a large negative voltage drop through its load and this voltage appears at G3.

The large plate current also flows through the common cathode resistor and a large negative bias is placed on G1 to cut off this tube. As the negative voltage leaks off C1 the grid becomes more positive and the other grid (G2) becomes more negative. Now T1 conducts and T2 is cut off. Plate voltage on T2 rises to the full power supply value and it appears on G3 as a high positive voltage.

After a short interval the high positive voltage on C1 discharges. G1 voltage becomes more negative and G2 more positive. As the T1 plate current drops the increasing voltage across its load is transferred to G2 through the condenser C2. Finally G2 reaches a high positive potential and the cycle repeats.

The frequency is determined by the rates of charge and discharge and is therefore controlled by B. The pulse width is determined by the ratio of C2 to C1. These condensers may be controlled simultaneously so that one increases as the other decreases. When C2 equals C1 the square wave is symmetrical.

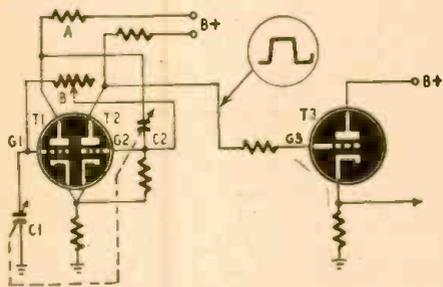

**ELECTRONIC MOTOR CONTROL**

Patent No. 2,440,600

Murray G. Crosby, Riverhead, N. Y.

(assigned to Radio Corp. of America)

Less than a volt is enough to start or reverse a motor operated by this circuit. The first tube is a mixer. About 0.6 volt at 60 cycles is applied to G1 to modulate the electron stream. The tap at P places about half this voltage on G3.

Some electrons are trapped by the screen which is not bypassed. This produces an a.c. voltage drop across the screen resistor. This voltage is 180 degrees out of phase with the potential applied to G3. P may be adjusted so that the two voltages have equal and opposite effects.

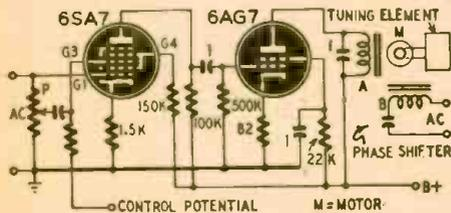

Balance is maintained until amplification due to G3 is changed. This may be done by a d.c. control potential. If this potential is positive the effect of G3 is greater than that of the screen which opposes it. A negative potential will cause the screen voltage to predominate. When the polarity of the control potential is reversed, so is the phase of the plate current.

The motor has two windings. The phase of B is shifted 90 degrees by a condenser. The current through A will then be either in phase or completely out of phase with the input a.c. Therefore it either leads or lags current through B by 90 degrees current. The motor runs in one direction or the other depending upon the polarity of the control potential. This voltage may be taken from a frequency discriminator. It will be positive or negative depending upon whether an incoming signal frequency is too high or too low.

the radio that **AMAZES** even the **EXPERTS**



There is no other radio like Hallicrafters precision-made Model S-38. Four bands bring you thrilling land, sea, air communications from all parts of the world plus finer quality on your favorite broadcast program. Perfect for den, library, office. Extra clear, strong reception anywhere. AC/DC. Write for Catalog P38 and where to buy. **\$47.50**

Model S-38 . . . \$47.50

**hallicrafters RADIO**

Get a Hallicrafters and listen for the Gatti-Hallicrafters mobile, radio-equipped expedition now operating via short wave from the Mountains of the Moon, Africa.

THE HALLICRAFTERS CO.

4401 W. Fifth Ave., Chicago 24, Illinois

**DUE TO POPULAR DEMAND**

**WE REPEAT THESE**

**TERRIFIC BARGAINS**

- Three assorted new MICROPHONES, including push-to-talk type . . . \$1.99
- Ten assorted R. F. Chokes including high frequency types . . . \$ .35
- Five assorted AUDIO or FILTER CHOKES . . . \$ .99
- One Hundred assorted RESISTORS. . . \$1.95
- Ten assorted JAN CABLE CONNECTORS, including SCR274,522 and BC375 types . . . \$ .99
- Six assorted OIL FILLED CAN TYPE CONDENSERS, all with mounting brackets . . . \$1.49
- Ten assorted METAL & BAKELITE KNOBS—(no wooden knobs) . . . \$ .39
- Six assorted VARIABLE CONDENSERS, including butterfly types . . . \$1.49
- Six assorted POWER and AUDIO TRANSFORMERS, all new . . . \$1.98
- Six assorted isolantite and bakelite R. F. COILS, shielded and unshielded . . . \$ .99

The above ten assortments totalling over \$12.00 at the unbelievable, bargain prices listed can be purchased together as one lot at a super-special total price of only \$10.00. All merchandise guaranteed to be as advertised.

**BUFFALO RADIO SUPPLY**

219-221 GENESEE STREET DEPT. 8C BUFFALO 3, N. Y.

**free radio book**

RADIOS HAM P.A.

Mail coupon for buying guide to the best values in Radio, Ham and P. A. Equipment. Send too for the newest flyer jam-packed with bargains.

**Spot-lite Values**

5BP1/5GP1

**C-R Tubes**

Brand new 5BP1/5GP1 cathode ray tubes, perfect for oscillograph use. Green fluorescence with medium persistence. Five inch screen, medium shell magnal 11 pin base. 6.3 volt heater, 2500 volts on anode No. 2. Each tube individually boxed. About one-tenth list price. Quantity extremely limited.

XPS916-5BP1 Tube

While They last. Your Cost . . . . .

**\$1.39**

**CINAUDAGRAPH High Fidelity CIN-12A 12" Cinaxial Speaker**

An exceptionally fine buy in high fidelity speakers. Especially designed for FM and television sound use. Assures efficient operation at all frequencies from 55 to 12,000 cps. The low frequencies are propagated in a large 12" unit and the high frequencies are produced in a smaller 3" unit mounted co-axially within the dimensions of the 12" speaker. A bridging network is built into the speaker to handle both units—no controls are necessary to allocate the crossover frequencies to the proper speaker unit. Especially designed for FM, the speaker is equally suited for use with a 10-watt output amplifier for television sound, wide range phonograph work, studio monitoring or similar installations of this rating. Voice coil impedance, 8 ohms; output, 10 watts; Alnico V magnet. Shpg. wt. 6 lbs.

X19118—

Your Cost . . . . .

**\$16.17**



from **Safayette**

MAIL NOW

New York  
100 SIXTH AVE.  
110 Federal St., Boston 10  
24 Central Ave., Newark 2

**Safayette Radio**

RADIO WIRE TELEVISION, INC.

Dept. JH-8, 100 Sixth Avenue, N. Y. 13

Send #XPS916 @ 1.39 ea. quantity

#X19118 @ \$16.17 ea. quantity

Enclosed: check  money order

Send catalog  New Flyer C42

Name . . . . .

Address . . . . .

City . . . . . Zone . . . . . State . . . . .

**CAN'T GET TO GOV'T SALES?**

Then the best thing is to get this

**SPECIAL GOV'T RADIO SURPLUS ASSORTMENT**

We buy large quantities of these items, divide them into choice assortments which we know you would be glad to have for this price if you could see them.

**\$25.00****CHEAPEST WAY TO BUY WAR SURPLUS RADIO MATERIAL**

On a deposit of \$5.00, we will ship you C.O.D. (Balance \$20.00 Freight Collect) an amazing quantity of surplus radio items, subject to your inspection and approval at freight station. Unless you are more than pleased, have Agent return to us, freight collect. Your money refunded immediately. All it will have cost you will be the freight charges one way!

In fact, you can probably sell just a few of the items you don't need, to more than cover cost of the entire lot. Our warehouses are filled with thousands of choice Gov't. Surplus Radio items. The cost of inventorying, itemizing, grouping, etc., would only multiply their cost to you. Therefore, we make this offer.

However, if you mention a few items you desire, we will try to include them in the assortment. Send for our special Value Bulletins on Radio and Photographic Supplies. Tell us your wants.

**GAS ENGINE POWER PLANTS BARGAIN PRICES FOR QUICK SALE**

2000 WATTS—115 V. D. C.	5000 WATTS—115 V. A. C.
17.4 Amps. Wisconsin type AEB, air-cooled 4 cycle engine.	54.8 amps @ 80% PF, 60 cycles. Onan JWC, 4-cylinder, 4 cycle gas engine. Water cooled. Remote start and stop.
1500 RPM .. <b>\$199.00</b>	..... <b>\$549.00</b>

All units reconditioned & guaranteed. Order now or write for further details. 20% deposit required with orders.

**The ABELL Distributing Co.**

7 E. BIDDLE ST. Dept. 11  
BALTIMORE 2, MD.

**OPPORTUNITY AD-LETS**

Advertisements in this section cost 25c a word for each insertion. Name, address and initials must be included at the above rate. Cash should accompany all classified advertisements unless placed by an accredited advertising agency. No advertisement for less than ten words accepted. Ten percent discount six issues, twenty percent for twelve issues. Objectionable or misleading advertisements not accepted. Advertisements for September, 1948. Issue must reach us not later than July 24, 1948.  
Radio-Craft • 25 W. B'way • New York 7, N. Y.

**RADIOMEN, SERVICEMEN, BEGINNERS — MAKE more money, easily, quickly, \$250 weekly possible.** We show you how. Information free. Merit Products, 216-32L 132nd Avenue Springfield Gardens 13, New York.

**BUILD A SUPERONIC OCTOMETER; AN ULTRA modern test instrument, incorporating a V.T. Voltmeter, V.T. Ohmmeter—Signal Tracer—Signal Generator—Amplifier—Auxiliary Power Supply—Speaker, Microphone and Pick-up tester.** In one small portable cabinet. For complete Diagrams, Schematics, Panel Template, Chassis layout, assembly and operating instructions, send \$2 and this ad. to: Grand Federal Supply, Box 57, Argentine Branch, Kansas City 3, Kansas.

**12B8 & 25B8 TUBES, BRAND-NEW, SOLD ON MONEY-back guarantee—\$2.49 each, 10 for \$22.50. Tubes & parts 60% to 80% off—write for free bargain catalog, Commercial Radio, 36 Brattle St., Boston 8, Mass.**

**WANTED: SOME 3526G RADIO TUBES. IRA L. LEE, Homagar, Ala.**

**SELECTED GROUP OF MEN, GRADUATES OF WELL-known trade school, desire employment in Radio Field. Will travel anywhere. Qualified in radio servicing, installation, test instruments, circuit operation, etc. Contact Placement Dept., Eastern Technical School, 883 Purchase Street, New Bedford, Mass.**

**EMERSON RADIO TUBES 60% OFF LAST. ALL TUBES individually boxed with 90-day Guarantee. Send for circular. Max Volplan, 13239 Third St. East, St. Petersburg 6, Florida.**

**MAGAZINES (BACK DATED)—FOREIGN, DOMESTIC, arts, books, booklets, subscriptions, pin-ups, etc. Catalog 10c (refunded), Cicero's, 883 First Ave., New York 17, N. Y.**

**WESTERN ELECTRIC CARRIER TELEPHONE AND Telegraph Equipment and Components. Filters, repeating coil, transformers, equalizers. Types CF1, CF2, H. C. and other carrier equipment. Telephone and telegraph repeaters. Box No. RC-46, Radio-Craft, 25 West Broadway, New York 7, New York.**

**YOU CAN ACCURATELY ALIGN SUPERHETERODYNE receivers without signal generator. Complete instructions \$1. Moneyback guarantee. Chas. Gates, Pecos 2, Texas.**

**LANCASTER, ALLWIN & ROMMEL, 436 BOWEN Building, Washington 5, D.C. Registered Patent Attorneys. Practice before United States Patent Office. Validity and infringement Investigations and Opinions. Booklet and form "Evidence of Conception" forwarded upon request.**

**AMATEUR RADIO LICENSES. COMPLETE THEORY preparation for passing amateur radio examinations. Home study and resident courses. American Radio Institute, 101 West 63rd St., New York City. See our ad on Page 89.**

**NEW CARTONED RADIO TUBES 39c. WRITE FOR bargain catalog. Henshaw Radio, 3313 Delavan, Kansas City, Kansas.**

**WE REPAIR ALL TYPES OF ELECTRICAL INSTRUMENTS, tube checkers and analyzers. Hazelton Instrument Co. (Electric Meter Laboratory), 140 Liberty Street, New York, N. Y. Telephone—BARCLAY 7-4339.**

**FM STATION LIST**

Next month we are printing a complete FM Station List. Managers and Chief Engineers of FM stations which have come into operation since our June list was published are invited to communicate with us, giving the call, and frequency of their stations. FM observers are also requested to help us keep our list up-to-date.

**... VARIABLE CONDENSER CLEANER**

When variable condenser plates are too close to clean with a pipe cleaner, put the cleaner in a vise and apply pressure. The new flattened shape will fit easily between most condenser plates.

H. R. NEWELL,  
Bradford, N. H.

**... RCA MODEL 85T**

The tubular condensers in this set usually go bad and cause intermittent reception. It is a good idea to check all these condensers when this set is brought in for repair.

BRIAN BAILEY,  
Brownwood, Texas

**... RADAIR MODEL 101**

If interference and oscillation is very noticeable, the set is probably out of alignment. The i.f. on this receiver is 2 mc, someone may have tried to align it with the signal generator tuned to 456 or 465 kc, since the proper frequency is not indicated on the chassis.

ARTHUR L. JOHNSON,  
Hutchinson, Kan.

**RADIO-CRAFT** wants *Technotes* describing common troubles of well-known receivers or telling how rare or difficult problems were solved. A six-month subscription will be awarded for each unillustrated and a one-year subscription for each illustrated *Technote* published.

**... ZENITH MODELS 5R216 AND 5S218**

Several of these receivers had the same complaint, low volume with a loud hiss on stations below 650 kc, even with a good antenna attached. Low-frequency stations came in much stronger when the chassis was turned on its side.

The trouble was traced to a shorted antenna coil primary. The improvement in reception when it was on its side was due to the unshielded antenna coil secondary acting as a directional loop antenna.

A universal replacement coil restored the set to normal.

WILLIAM FORD,  
Chicago, Ill.

**... REDUCING DRAIN**

When using an external device, such as a phono preamplifier, which draws its power from the receiver or amplifier, current drain on the filament supply can be reduced by replacing the pilot lamp with one of lower current rating. For 6.3-volt lamps, use No. 40 or 47 (brown bead) to replace No. 44 or 46 (blue bead), saving 100 ma. For 2.5-volt lamps, use No. 42 (green bead) to replace No. 41 (white bead), saving 150 ma.

LEWIS SWANSON,  
Toronto, Ontario

**... PHILCO 1201 SERIES**

If a very loud hum appears (it may show up as an intermittent buzz), regardless of the setting of the volume control, check for a short where the wires to the phono motor switch pass through a metal sleeve.

GORDON S. WEEKS,  
High Springs, Fla.

RADIO-CRAFT for

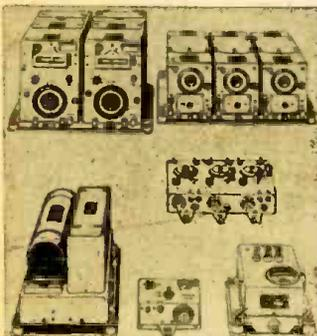
**SCR-274N COMMAND SET**

The greatest radio equipment value in history

A mountain of valuable equipment that includes 3 receivers that use plug-in coils, and consequently can be changed to any frequencies desired without conversion. Also included are two Tuning Control Boxes; 1 Antenna Coupling Box; four 28V. Dynamotors (easily converted to 110V. operation); two 40-Watt Transmitters including crystals, and Preamplifier and Modulator. 29 tubes supplied in all. Only a limited quantity available, so get your order in fast. Removed from unused aircraft and in guaranteed electrical condition. A super value at \$34.95, including crank type tuning knobs for receivers.

**BUFFALO RADIO SUPPLY 219-221 GENESEE STREET**  
BUFFALO 3, N. Y. DEPT. 8C

**SPEAKER REPAIR**

When a speaker voice coil is rubbing against the pole pieces, find out which side of the voice coil is rubbing by gently prodding the center of the cone with the fingers. Then insert a piece of cotton or a ball of paper between the cone and the speaker frame in such a position that the voice coil no longer rubs. Dampen the cone lightly with carbon tetrachloride. When it is dry remove the paper or cotton. The rubbing will usually have been eliminated.

K. E. STEWART,  
Moberly, Mo.

**CONTINENTAL MODEL 6C**

A particularly irritating grinding noise in this set sounded like local interference. Noise-reducing methods had no effect. The defect was finally localized in a partially open filter condenser by the use of a condenser analyzer.

BRIAN BAILEY,  
Brownwood, Texas

**AUTO SETS**

To find out if the vibrator power pack in an auto set is defective, disconnect the B-plus lead and supply the high voltage from an external power pack or dynamotor. The filament voltage is supplied by the battery. If the set now operates, the trouble is in the power supply.

A light current drawn from the battery before the B-plus lead was cut indicates a probably defective vibrator. If the current is excessive, either the buffer condenser is shorted or the vibrator points are sticking.

FRED P. STEINMETZ,  
Chandler, Indiana

**PHILCO 41-605**

Heating of the power supply voltage-divider resistor was caused by a shorted filter condenser.

Replacing the XXD tube with a 14AF7 caused oscillation at the high-frequency end of the dial. This was cured by replacing the 10,000-ohm oscillator plate circuit resistor with a 5,000-ohm resistor.

TEWS RADIO SERVICE,  
Milwaukee, Wis.

**ADMIRAL CHANGERS**

A common trouble is failure of the changer to complete its cycle. This is often due to a worn drive wheel (part No. G400 A179). Wear can be detected by running the fingers around its rubber tire. Replace it if it is bad.

Another common difficulty is failure of the set-down assembly (part No. G400 A152). If the adjusting screws will not index properly, the set-down assembly may be slightly bent and scraping against the frame. Straightening it will complete the repair.

EARL E. WEITZ,  
Chicago, Ill.

**VIBRATOR REPAIR**

When replacement vibrators are hard to get, the technician may repair the old one by filing the contacts. To observe the repaired unit in operation, use a neon lamp as a stroboscope.

The usual frequency of a vibrator is in the neighborhood of 120 cycles. This is

a multiple of the 60-cycle line frequency. A neon bulb connected to the 60-cycle line and held near the moving vibrator contacts will make them appear to stand still or slow down. Improper operation can easily be noticed.

For best results, the room should be darkened so that the only light shining on the vibrator is that from the neon lamp.

A. CREMAILH,  
Douala,  
French  
Cameroon

(Vibrators repaired by filing the contacts often become defective again very soon, and the technician should replace worn vibrators except of course in cases like that above, where obtaining a replacement might take many months. —Editor)

**New! TWIN-TRAX\* TAPE RECORDER**  
provides **FULL HOUR** of **Continuous High Fidelity Recording and Play-Back**



- Frequency range 50 to 9000 cycles  $\pm 3$  db.
- Individual bass and treble equalization controls.
- Five watts output.
- Portable and standard models available.
- Extremely low hum level. (DC on heaters).
- 16" wide by 14 1/4" deep by 13" high.
- Provision for playing disc records.
- Earphone jack provided.
- Sockets for VU meter and foot switch.
- All components easily accessible.
- Heavy duty recording motor. (Eliminates possibility of overheating).
- Flutter and wow negligible.

Through a revolutionary method of recording on two tracks on the tape instead of a single track, your playing time is doubled, resulting in greatly increased convenience, and tape costs cut in half! An automatic switch and solenoid instantly reverses the direction of the tape at the end of the reel, eliminating the necessity for rewinding. No special knowledge is required to attain professional results! The ideal recording-playback instrument for the home, industry, laboratory, and broadcast studio.

Here is a magnetic tape recorder that's new, different, and better! It enables you to record and play back music and voice with a quality of performance unmatched by any other means, and offers this extra added premium — a full hour's program of high fidelity recording on a standard 1/2 hour reel of magnetic tape running at the standard 7 1/2" per second.

But that's not all you get in this ultra-modern TWIN-TRAX recorder. Not only can microphone recordings be made easily, but a simple connection made on the recorder for copying your valued disc records.

If not available at your dealer, order direct, or send for literature describing and featuring the amazing TWIN-TRAX recorder. \*Trademark

A. C. Shoney's Famous Booklet  
"ELEMENTS OF MAGNETIC TAPE RECORDING AND 999 APPLICATIONS"  
Is Still Available at 25¢

Price \$219.50  
less microphone

**AMPLIFIER CORP. OF AMERICA**

398-10 Broadway New York 13, N. Y.

**COMBINATION "DYNOPTIMUM" TUBE and SET TESTER**

Model 802-N

A compact, low-priced instrument for greater profits  
**ONLY \$59.50**

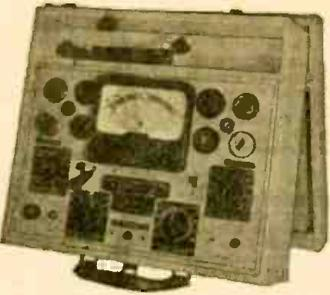

Multiply your productive service time with this completely modern, accurate tube and multitester. It provides maximum test operations with minimum switch settings—speeds your service checks for field and counter work. Order from your local jobber. Write direct for catalog.

- Check these features:
- Simple to operate as a tube tester or set tester—combining accuracy and speed
  - Usual AC voltage errors due to frequency and temperature virtually eliminated with germanium crystal rectifier
  - Tests paper, mica and electrolytic condensers for leakage
  - Resistance measurements through a 200 million to 1 range
  - Famous Dynoptimum circuit for tube testing—giving accurate speedy tests for quality—short—leakage and noise
  - Set tester includes AC—DC voltmeter—output meter—decibel meter—ammeter—milliammeter—ohmmeter—all multirange
- R.C.P. INSTRUMENTS... BEST FOR EVERY TEST

**RADIO CITY PRODUCTS CO., INC.**  
152 West 25th Street New York, N. Y.

**GENERAL ELECTRIC RT-1248 15-TUBE TRANSMITTER-RECEIVER**

TERRIFIC POWER—(20 watts) on any two instantly selected, easily pre-adjusted frequencies from 435 to 500 Mc. Transmitter uses 5 tubes including a Western Electric 316 A as final. Receiver uses 10 tubes including 955's, as first detector and oscillator, and 3-7HT's as IF's, with 4 slug-tuned 40 Mc. IF transformers, plus a 7HT, 7E6's and 7E7's. In addition unit contains 8 relays designed to operate any sort of external equipment when actuated by a received signal from a similar set elsewhere. Originally designed for 12 volt operation, power supply is not included, as it is a cinch for any amateur to connect this unit for 110V AC, using any supply capable of 400V DC at 135MA. The ideal unit for use in mobile or stationary service in the Citizen's Radio Telephone Band where no license is necessary. Instructions and diagrams supplied for running the RT-1248 transmitter on either code or voice in AM or FM transmission or reception, for use as a mobile public address system, as an 80 to 110 Mc. FM broadcast receiver, as a Facsimile Transmitter or receiver, as an amateur television transmitter or receiver, for remote control relay hookups, for Geiger-Mueller counter applications. It sells for only \$29.95 or two for \$53.90. If desired for marine or mobile use, the dynamotor which will work on either 12 or 24V DC and supply all power for the set is only \$15.00 additional.

BUFFALO RADIO SUPPLY  
219-221 Genesee Street, Buffalo 3, N. Y. Dept. 8C

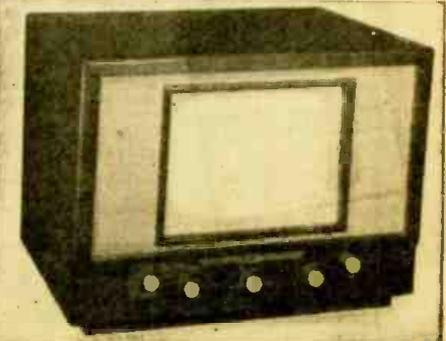

**MASTERPIECES in CABINETRY**  
Television cabinets specially engineered for 12" and 15" Staudard and De Luxe "Transmission" models. Also available for 12" and 15" Standard and Champion "Television Assembly" models. Exclusively designed tables to match. Various finishes. Write for particulars, Dept. B.  
**TEL-CRAFT COMPANY**  
108 Havemeyer St., Brooklyn 11, N. Y.

Edited by ELMER R. FULLER

# Get All 10

ONLY 50c EACH  
\$5.00 SET OF 10

## These Books Keep You On Your Toes!

Here are a total of 640 pages of downright practical knowledge to help you keep punching away at the unknown factors of radio until you have mastered them. Every one of the 10 is worth many times its 50c price if you will just apply a small portion of the information gained to your daily work. You'll be glad you have the complete set handy whenever you are trying to work out a particular problem in construction, testing or servicing. You'll like the easy-to-read type—the clean-cut printing—the smart, modern, flexible covers, and the great number of illustrations. They all help to make learning a pleasure. Order as many as you need today—better still, make it all 10.



**No. 29—HANDY KINKS AND SHORT CUTS.** A carefully edited compilation of time savers. Kinks on Antennas—Power Supplies—Test Equipment—Servicing—In the Shop—Phonographs and Amplifiers—Coils and Transformers—Miscellaneous.

**No. 30—UNUSUAL PATENTED CIRCUITS, 1944-1946.** A gold mine in new hook-ups! A selection of unusual circuits, many a result of wartime research—of great value to anyone interested in electronics. Control Circuits—Detectors and Amplifiers—Power Supplies—Miscellaneous Circuits—Foreign Circuits.

**No. 31—RADIO QUESTIONS AND ANSWERS.** Answers to most frequently asked questions. Clear schematics. Amplifiers—Receivers—Transmitters—Meters and Test Equipment—Interphones—Power Supplies—Phono Amplifiers—P. A. Systems.

**No. 32—ADVANCED SERVICE TECHNIQUE.** An up-to-date collection of information for the advanced serviceman; Visual Alignment—Tracking Problems—Negative Feedback—Tone Control Circuits—Adding Microphones to Sets—Matching Loudspeakers—Remote Juke Boxes—Servicing Record Changers—Hum Elimination—FM Servicing.

**No. 33—AMPLIFIER BUILDER'S GUIDE.** Invaluable for the designer and builder of audio equipment. Tells how to build a wide variety of amplifiers. Detailed design information on: Push-Pull—Phase Inversion—Bass and Treble Boosters—Volume Expanders—Resistance Coupling—Internal Feedback.

**No. 34—RADIO-ELECTRONIC CIRCUITS.** An extensive collection of circuit diagrams, with brief, to-the-point descriptions of each, including: Intercommunications Systems—Power Supplies—Balancing Circuits—V.T. Voltmeters—Amplifiers—Receivers—Phono Amplifiers—Short Wave Adaptors—Electronic Relays.

**No. 35—AMATEUR RADIO BUILDER'S GUIDE.** For the "ham" who builds his own. Practical, down-to-earth. Tells you how to Build: A 2 Meter Band Acorn Tube Set—Miniature Communications Receivers—Long Lines Transmitter—Beginner's Transmitter—Preselector—Rotary Beam Aerial—Power Supplies, etc.

**No. 36—RADIO TEST INSTRUMENTS.** A MUST for every radio man. This latest book on building test equipment places emphasis on practical construction; Signal Tracers—Capacity Meters—Portable and Bench Multi-checker—Signal Generators—Tube Checkers—Electronic Voltmeters—and many others.

**No. 37—ELEMENTARY RADIO SERVICING.** For the radio man who knows little about servicing. How to get started, and even more important, how to keep going: Planning the Service Shop—Equipping the Shop—Systematic Circuit Checks—Signal Tracing Methods—Servicing the Midset—Soldering—Servicing Volume Controls—How to Service Speakers.

**No. 38—HOW TO BUILD RADIO RECEIVERS.** This book contains a sufficient variety of sets to appeal to every radio fan. Includes: Short-Wave, Broadcast, Portable, A.C. Operated, Miniature and Standard Receivers. Complete coil-winding data.

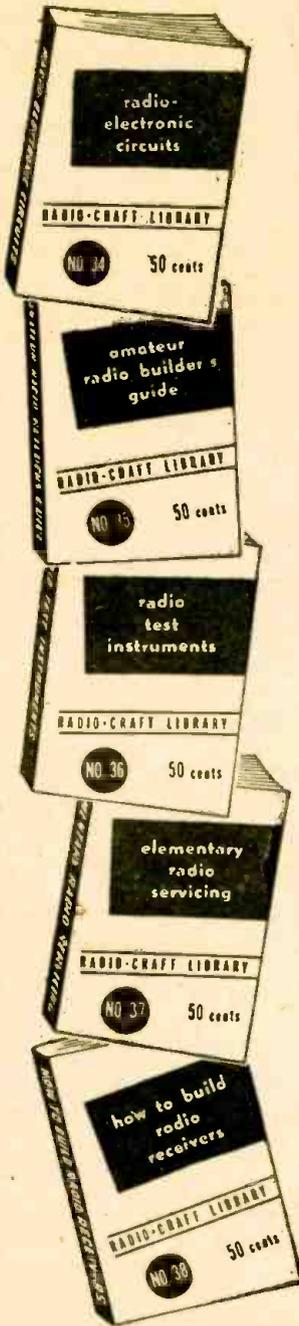

READERS have noted that this department has skipped a few issues during the past several months. This has been due to the new FM station list. In the future, the Short-Wave Station List will appear in two sections in successive months, and the FM List will appear the third month. A complete world-wide log will be printed in the October and November issues (half in each issue) so be on the lookout for it.

Below you will find something different than we usually print in this department. Here is a list of the least-heard and possibly hardest-to-get stations. We would like to have you do a little dial twisting, and give us a report on any of them that you hear. Most of them have been reported as being received on the east coast, so they are not impossible to get.

A Dx-ers program from Sweden is transmitted every Saturday on 6.065 mc and on 15.155 mc at 0245 EST, with a second transmission on 10.780 mc and on 15.155 mc at 1000, and a third transmission on 9.535 mc and on 10.780 mc at 2000, EST. Reports may be sent to Dx Editor, Radiotjanst, Stockholm.

Radio Monte Carlo is now using 6.035 mc and may be heard from 0230 to 0430, 0700 to 0900 and 1400 to 1815 daily. Reports may be sent to: Radio Monte Carlo, 16 Bd Princesse Charlotte, Monte-Carlo, Monaco.

Freq.	Station	Location and Schedule
3.910	ZQP	LUSAKA, SOUTHERN RHODESIA: 1030 to 1200
4.780		SINGAPORE, MALAYA; 0345 to 1000; 2330 to 0130
4.900	ZOH	COLOMBO, CEYLON; 0430 to 1145
4.940	HJCV	BOGOTA, COLOMBIA; 0645 to 1115; 1600 to 2315
5.880	ZRK	CAPETOWN, SOUTH AFRICA; 2345 to 0130; 1100 to 1600
5.980		ANDORRA; 0600 to 0830; 1300 to 1900
6.040		RANGOON, BURMA; 0915 to 1015
6.060		TETUAN, SPANISH MOROCCO; 0230 to 0300; 1330 to 1500
6.100	VUD3	DELHI, INDIA; 1200 to 1245
6.100		WARSAW, POLAND; 1100 to 1800
6.150	EQB	TEHERAN, IRAN; 0930 to 1400; 2230 to 2315
6.150	CS2WD	LISBON, PORTUGAL; 1330 to 1800
6.200	FK8AA	NOUMEA, NEW CALEDONIA; 0200 to 0400; 0430 to 0500
6.360	HRPI	SAN PEDRO SULA, HONDURAS; 1100 to 1415; 1800 to 2330
6.370	CSX	LISBON, PORTUGAL; 1230 to 1800
6.770		SINGAPORE, MALAYA; 0330 to 1200
7.100		BISSAU, PORTUGUESE GUIANA; 1315 to 1730
7.130	VQ6MI	HARGEISA, BRITISH SOMALILAND; 0600 to 1030; 1200 to 1300
7.290	VUD3	DELHI, INDIA; 0800 to 1100; 1730 to 1825; 2100 to 2300
7.290	ZOY	ACCRA, GOLD COAST; 1045 to 1300
7.570	EAJ43	SANTA CRUZ, CANARY ISLANDS; 0730 to 0900; 1230 to 1700
7.850	ZAA	TIRANA, ALBANIA; 1300 to 1630
7.950		ALICANTE, SPAIN; 0700 to 1000; 1400 to 1800
8.030	FXE	BEIRUT, LEBANON; 0000 to 0115; 0515 to 0800; 1030 to 1600
9.080	CNR3	RABAT, MOROCCO; 0145 to 0500; 1315 to 1900
9.370	EAQ	MAORIO, SPAIN; 1330 to 1600; 1830 to 2200
9.460	TAP	ANKARA, TURKEY; 1000 to 1615; Sun, Mon, Thurs, 1530 to 1545
9.500	OIX2	LAHTI, FINLAND; 0100 to 0130; 0610 to 0740; 1000 to 1600
9.520	ZRG	JOHANNESBURG, SOUTH AFRICA; 0900 to 1045
9.520	OZF	COPENHAGEN, DENMARK; 1145 to 1545
9.520	SEAC	COLOMBO, CEYLON; 1930 to 1900
9.700		FORT DE FRANCE, MARTINIQUE; 1730 to 1845; and later
11.040	CSW6	LISBON, PORTUGAL; 1230 to 1530; 1600 to 1800
11.090		PONTA DEL GADA, AZORES; 1500 to 1600
11.730		SINGAPORE, MALAYA; 0325 to 1200
11.830		CONSTANTINE, ALGERIA; 0130 to 0315; 0630 to 0915; 1315 to 1400; 1430 to 1700
15.270		SINGAPORE, MALAYA; 0330 to 1200
15.290	VUD11	DELHI, INDIA; 2215 to 0430; 0125 to 0150; 0200 to 0400; 0500 to 0700
15.300		SINGAPORE, MALAYA; 0330 to 1200
17.770	SEAC	COLOMBO, CEYLON; 2300 to 0730; 1100 to 1200
18.130	PMC	BATAVIA, NETHERLAND INDIES; 1100 to 1130

# RADIO-CRAFT LIBRARY SERIES

RADCRAFT PUBLICATIONS, Dept. 88  
25 West Broadway, New York 7, N. Y.

See Your Radio Dealer  
If He Can't Supply You, Use Coupon

Send me the volumes (50c each, postpaid) checked. My radio dealer is  All 10 Books \$5.00  
unable to supply.  29  34

I enclose \$.....  30  35

Your Name ..... (Print Clearly)  31  36

Address .....  32  37

Dealer's Name .....  33  38

Address .....



**FM PRODUCTION BOOM**

FM will become a \$750 million business by the end of this year, predicted "Bill" Bailey, recently. Bailey, executive director of the FM Association, a group composed of FM station licensees, said that over \$48 million has already been invested by FM stations, with an additional \$54 million investment to be made by the 543 construction permit and conditional grant holders.

More than two million receivers have been produced since the war's end, said Bailey, and an estimated five to eight million will be turned out during 1948. Production during the first quarter of this year was roughly a half million.

Retail value of RMA-manufactured sets in 1947 was over \$311 million for the 1,175,000 units made. \$500 million is the figure predicted for this year.

According to the FCC, commercial FM stations now on the air total 482, with 543 construction permits and 47 applications pending.

**FM HOMES DOUBLE IN YEAR**

FM receiver ownership is well over 156,000 in the metropolitan New York area, according to a survey made recently by The Pulse, Inc., radio research organization. This is more than double the number in the area as compared with January, 1947. The area covered by the survey has approximately 28 million radio homes. The figures show that the percentage of homes where there are FM sets is about 5.6.

**TAX HITS BRITISH RADIO**

British radio sales have experienced a serious slump of late, blamed by the makers on the high government purchase tax. The levy has increased to 66 2/3% in the last two national budgets, from its former figure of 33 1/3%.

As a result, over 10,000 of the 55,000 radio factory workers in England have lost their jobs, and two manufacturers have gone out of business.

The Radio Industry Council, representing British radio makers, has appealed to Sir Stafford Cripps, Chancellor of the Exchequer, to reduce the tax to 33 1/3% and to do away with it for television receivers and tubes.

**HIGHER POWER FOR WRUL**

International shortwave radio WRUL (Boston, Mass.) has applied to the FCC for permission to increase its power to 250,000 watts. This would make it the most powerful broadcaster in the Western Hemisphere.

**GE STARTS TV RESEARCH**

A new television division has been set up in the General Electric research laboratory, Dr. C. G. Suits, GE vice-president and director of research, announced last month. He explained that in view of the company's large activity in television, it was appropriate that it be in a position to make basic contributions to the art.

**RADIOMEN! ELECTRICIANS!**

Get this Valuable Book **FREE**

for Merely Examining Coyne's NEW Pay-Raising

**5 VOLUME APPLIED PRACTICAL RADIO SET**

Here's a PRACTICAL set of radio books just off the press! Gives you "know how" on everything in Radio today. Basic principles to newest in Television and F.M.—how construct, install, service. Latest trouble-shooting methods. 1000 illustrations, over 1500 pages. Ideal for reference or home training. To prove how valuable these great books can be to you, Coyne will give you a FREE copy of our new, helpful "150 New Radio Diagrams Explained" for looking over the 5 Vol. Set. OFFER LIMITED—ACT NOW! We will send you 5 vol. set APPLIED PRACTICAL RADIO for 7 days FREE examination, together with Radio Diagrams. Look set over for 7 days. If you like it send \$15 cash, or \$3 after 7 days and \$3 monthly until \$18.75 is paid.

If you don't want the set, return it and you owe NOTHING. Either way you keep Diagrams Book Free. SEND NO MONEY! Coupon asks to see books free and get your gift book for doing it! Send coupon NOW!

**FREE BOOK COUPON**

Educational Book Publishing Division  
COYNE ELECTRICAL & RADIO SCHOOL, Dept. C-8-T1  
500 South Paulina St., Chicago 12, Illinois

OK, Send me, postpaid, Coyne's new 5 volume set, "APPLIED PRACTICAL RADIO" for 7 Days FREE TRIAL per your offer. Also send, absolutely FREE, "150 New Radio Diagrams Explained" as a gift.

NAME.....AGE.....  
ADDRESS.....  
TOWN.....ZONE.....STATE.....

**SPERRY TUBES**

6A8	.64
6C5	.59
6D6	.59
6F6	.69
6H6	.54
6K7	.59
6Q7	.69
6SA7	.59
6SH7	.54
6SN7	.69
6V6	.54
7C5	.69
7F7	.69
7Y4	.69
12A6	.49
12J5	.54
12SK7	.59
24a	.49
25Z5	.54
27	.54
80	.49

**TURBO AMPLIFIERS**  
Aircraft Amp.  
Ideal for parts  
**\$1.95**

MIN. DEPOSIT OR ORDER \$3.00  
20% ON LARGER ORDERS

**KAY ELECTRONICS CO.**  
P.O. BOX 25 HOLLIS 7, N. Y.

**PEN-OSCIL-LITE**

Extremely convenient test oscillator for all radio servicing; alignment • Small as a pen • Self powered • Range from 700 cycles audio to over 600 megacycles u.h.f. • Output from zero to 125 v. • Low in cost • Used by Signal Corps • Write for information.

**GENERAL TEST EQUIPMENT**  
38 Argyle Ave. Buffalo 9, N. Y.

**\$3.00 FOR CARTOON IDEAS**

RADIO-CRAFT prints several radio cartoons every month. Readers are invited to contribute humorous radio ideas which can be used in cartoon form. It is not necessary that you draw a sketch, unless you wish.

**IDEAS NOT WANTED**  
No electrical or radio definitions wanted. Some of these were published in the past, but the subject is about exhausted.

All checks are payable on publication.  
Address **RADIO CARTOONS, RADIO-CRAFT**  
25 West Broadway, New York 7, N. Y.

**MORE AND MORE TUBES!**  
are bought from Senco

Your tube worries are over when you buy from Senco. With each and every purchase, you are assured of the best—GUARANTEED—merchandise at phenomenally low prices. Our policy of quantity buying, low overhead, cash sales, direct merchandising—eliminating all unnecessary expenses that add to your price—enables us to pass these large savings along to you. Compare our tube list now and prove to yourself that only Senco gives you these values!

**THOUSANDS OF TUBES!— ALL BRAND NEW!— Individually Cartoned! R.M.A. GUARANTEE IMMEDIATE DELIVERY!**

Type	Each	10	Type	Each	10
024	69c	59c	6V6GT/G	45c	39c
1A3	45	39	6X5GT/G	49	39
1A5GT/G	59	49	7A4	53	43
1A7GT/G	55	45	7A7	59	49
1H5GT/G	59	49	7B6	44	35
1L4	49	45	7F7	49	44
1L4A	49	39	7N7	49	44
1LH4	69	59	7X7		
1LN5	69	59	(XXFM)	44	35
1N5GT/G	59	49	7Y4	44	35
1R5	55	49	12A6	29	25
1S5	59	55	12A8GT	35	28
1T4	69	55	12A76	50	45
1T5GT	59	49	12A77	69	59
1U5	36	30	12BA6	50	45
1V	45	39	12BE6	50	45
2A5	54	43	12F6GT	35	27
2A6	45	35	12HG	39	34
2A7	49	39	12J5GT	25	19
2X2/879	35	29	12J7GT.	45	39
3A4	49	39	12K7GT	45	39
3Q5GT	55	49	12K8Y	35	25
3S4	55	45	12Q7GT	45	39
3U4G	50	40	12SA7GT/G	40	32
3W4GT/G	39	34	12SC7/1634	49	39
3X4G	39	35	12SF7	35	32
5Y3G	42	37	12SG7	43	37
5Y3GT/G	40	33	12SJ7GT	55	49
5Y4G	39	32	12SK7GT/G	45	35
5Z3	49	39	12SL7	49	43
5Z4	59	49	12SQ7GT/G	40	32
6A7	50	45	12SR7	35	32
6A8GT	49	39	14A7	65	55
6A87/1853	53	46	14B6	59	49
6A9	69	59	24A	49	39
6AC7/1852	65	60	24B6	69	59
6AG7/6AK7	89	79	25L6GT/G	49	39
6AK5	74	69	25Z5	49	45
6B7	55	49	25Z6GT/G	45	39
6B6G	79	69	26	45	32
6BJ6	69	59	27	49	44
6C4	29	25	32L7GT	52	48
6C3GT	40	35	35/51	42	32
6C5MG	89	79	35L6GT/G	45	39
6C6	45	32	35W4	43	40
6C8G	37	29	35Y4	43	40
6D6	49	45	35Z3	44	35
6F5	55	45	35Z5GT/G	43	39
6F6GT	45	39	36	35	29
6H6GT/G	45	39	39/44	35	29
6J5GT/G	45	39	41	40	43
6J6	59	49	42	47	41
6J7G	42	38	43	54	47
6K6GT/G	45	39	45	49	39
6K7G	50	41	45Z5GT	59	49
6K7GT/G	49	39	47	49	39
6K8G	55	49	50A5	60	55
6L6G	79	69	50B5	42	32
6N7	84	73	50L6GT	50	45
6P5GT	59	49	50Y6GT	50	45
6Q7GT	47	39	56	55	45
6R7	55	45	57	45	39
6R7GT	59	49	58	45	39
6S47	49	39	71A	39	29
6SA7GT/G	44	37	75	50	39
6SB7	55	45	76	49	45
6SD7GT	39	34	77	35	27
6SF5	49	39	78	49	39
6SG7	44	39	80	40	38
6SH7GT	40	32	83V	79	69
6S7GT	44	37	84/6Z4	49	39
6SK7GT/G	49	39	85	49	45
6SL7GT	49	47	99V	35	25
6SN7GT	49	47	99X	35	25
6SQ7GT/G	44	37	117Z6GT/G	89	76
6SD7	49	39	182B	99	89
6U6	49	39	1231	39	29
6U7G	35	25	1644	39	29
6V5G	59	49			

**MINIMUM ORDER \$1.00**  
WHEN ORDERING—Send 25% deposit for all C.O.D. Shipments. Include sufficient postage—excess will be refunded. Orders without postage will be shipped express collect. All prices F.O.B. New York City.

**SENCO RADIC INC.**

73 West Broadway New York 7, N. Y.  
Telephone BEekman 3-6498

# "Communications"

## BEAM ROTATING MECHANISM



The most useful, powerful, compact assembly offered on surplus for beam rotation. 90:1 gear ratio turned by 24 vdc motor that will run on 12 vac. Bicycle type sprocket for easy coupling to any shaft. 3/4" x 3/4" x 4". With mounting facility. New.

Guaranteed, complete with 110 vac to 12 vac step-down xfmr ..... **\$16.50**

## DYNAMOTORS

Type	Input Volts	Output Amps	Radio	Price*
BD 77KM	14 40	1000 .350	BC 191	\$0.95LN
PE 73	28 19	1000 .350	BC 375	\$4.95N
DM 21	14 3.3	235 .090	BC 312	\$2.79LN
DM 21CX	28 1.6	235 .090	BC 312	\$2.49N
DM 25	12 2.3	250 .050	BC 327	\$2.49LN
DM 28R	28 1.25	275 .070	BC 348	\$5.00N
DM 33	28 7	540 .250	BC 458	\$3.95N
DM 42	14 46	515 .110	SCR 506	\$3.95LN
		1030 .050		
		2/8		
PE 55	12 25	500 .400	SCR 245	\$4.95LN
PE 86 N	28 1.25	250 .090	BC 36	\$1.95N
PE 101 C	13/26	12.6/ 400	.135 SCR 515	\$3.49N
		6.3	800 .020	
		9 AC 1.12		
BD AR 93	28 3.25	375 .150		\$4.95N
23350	27 1.75	285 .075	APN-1	\$3.50N
35X045B	28 2.2	250 .090		\$2.25N
ZA 0515	12/24	4/2 500 .050		\$3.95N
ZA 0516	12/24	8/4 275 .110		\$4.25N
B-19 pack	12 9.4	275 .110	Mark II	\$6.95N
		500 .050		

\*N—New. LN—Like New.

## TRANSMITTER TUNING UNITS

From BC 375: TU-9 (7.7-10 mc); TU 10 (10-12.5 mc)  
TU 22 (350-650 kc); TU 26 (200-500 kc) \$2.25 Each  
For BC 610: TU 48 (2.5-3 mc); TU 52 (6.35-8 mc);  
TU 53 (8-12 mc) ..... \$1.75 Each  
BC 223 AX: TU 17 (2-3 mc); TU 18 (3-4.5 mc) ..... \$1.95 Each

## INSTRUCTION MANUALS

BC 312, BC 342 ..... \$1.25  
SCR 281 ..... \$1.25 MARK II ..... \$1.75  
ZA Expt ..... \$1.75 SCR 508 ..... \$1.00

## BC 221 FREQ. METER ASSEMBLY

Ideal foundation unit for an extremely stable VFD or Fraud. meter. Consists of temperature compensated coils and capacitors. Tunes with 220 mmf. condenser. Low range: 125-250 kc; high range: 2000 to 4500 kc. New, with 220 mmf capacitor and BC 221 schematic **\$7.95**

**BAND PASS FILTER, #70473.** Sharp band pass peaked at 975 cps (tunable). High-to-high impedances. Can be plugged into phone output of receiver. Cuts out QRM and QSB. New, with circuit diagram **\$2.25**

## CATHODE RAY TUBES

3BP1	..\$1.25	3FP7	..\$1.20	5FP7	..\$1.75
3DP1	..\$2.25	3GP1	..\$3.95	5JP2	..\$4.00
3EP1	..\$2.95	5BP1	..\$1.20	12GP7	..\$10.95

**5130 THE NEWEST THING IN UHF, 10-350 MC. MAGNETRON IN GLASS ENVELOPE. NEW, COMPLETE WITH DATA SHEET \$39.50.**

A complete line of microwave eqpt. in stock: 10cm, 3cm, 1.25cm. Send for microwave flyer.

**ANTENNA AN/122-A.** Dipole, 12' L. Ideal for that 6 meter beam. One side of dipole adjustable for fine tuning. Get four of them for only \$20.00, or \$5.65 each.

**ANTENNA AN/104-A.** The best deal for two meters. 21' L. of aluminum construction, with 831B connector, all set to go. \$7.75 ea. or 2 for \$13.35

**ANTENNA AN/128-A.** A complete two-meter beam, originally designed to work with IFF set BC 148-A. This unit is extremely compact, rugged, efficient. Consists of two vertical radiators working against a square reflector 3' x 4'. You can't beat this unit for high gain and directivity. NEW. \$40.00

## VARIABLE AIR CAPACITORS

2 sect. 365mmf/sec. with cable drive wheel attached. \$ 9.95  
7 sect. 1-75 mmf. 4-100 mmf. 2-200 mmf. Vernier rt. angle drive, 60:1. Size: 11" x 3" x 3". Completely shielded ..... \$3.25  
ARC No. 6558 variable receiving capacitor. 62mmf/section. 3 sections. .03" spacing. 8 rotors. Worm drive ratio 33:1 ..... \$1.75  
ARC No. 4990 variable xmtg. capacitor. 22.4-145 mmf. .05" spacing. 11 rotors. Each ..... \$1.00  
ARC 5032 Var. Xmtg. capacitor. 29.2-117 mmf. .06" spacing 16 rotors. worm drive; 96:1 ..... \$1.00

## CROSS POINTER INDICATOR

Two 0-200 microamp. movements in 3" case. Each movement brought out to 6-term. receptacle at rear. Originally used in ILS equip. **\$2.50**



All merchandise guaranteed. Mail orders promptly filled. All prices F.O.B. New York City. Send Money Order or Check. Shipping charges sent C.O.D. Rated concerns send P.O.

## COMMUNICATIONS EQUIPMENT CO.

131-C Liberty St., New York City 7, N. Y. Digby 9-4124

# HARD-TO-GET PARTS

POWERFUL ALL-PURPOSE INDUCTION MOTOR

IDEAL FOR EXPERIMENTERS—101 USES

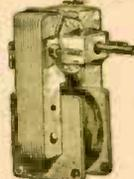

Sturdily constructed to precision standards, this self-starting sanded pole A.C. induction motor is powerful enough for a number of uses. Some of these are: Automatic Timing Devices, Current Interrupters, Electric Fans, Electric Chimes, Window Displays, Photocell Control Devices, Electric Vibrators, Small Grinders, Buffers and Polishers, Miniature Pumps, Mechanical Models, Sirens, and other applications.

Consumes about 15 watts of power and has a speed of 3,000 r.p.m. When geared down, this sturdy unit will constantly operate an 18-inch turntable loaded with 200 lbs. dead weight—THAT'S POWER!  
Dimensions 3" high by 2" wide by 1 3/4" deep; has 4 convenient mounting studs; shaft is 1/8" long by 3/16" diameter, and runs in self-aligning retaining bearings. Designed for 110-20 volts, 50-60 cycles, A.C. only. Shp. Wt. 2 lbs.  
ITEM NO. 14  
YOUR PRICE ..... **\$2.95**

## ULTRA MAGNET

LIFTS MORE THAN 20 TIMES ITS OWN WEIGHT

## LITTLE GIANT MAGNET

Lifts 5 lbs. easily. Weighs 4 oz. Made of ALNICO new high-magnetic steel. Complete with keeper. World's most powerful magnet. The experimenter and hobbyist will find hundreds of excellent uses for this high quality permanent magnet. Measures 1 3/4" x 1 1/4" Shp. Wt. 3 1/2 lbs.  
ITEM NO. 159  
YOUR PRICE ..... **\$1.50**



## GENUINE MICROPHONE TRANSMITTERS



Regular telephone transmitters taken from a large telephone supply company's overstock. Work perfectly on telephone cells. Can be used on P.A. systems, call systems, intercommunications, a e. t. c. short-line telephone circuits, house-to-house or farm-to-farm phone lines, also to talk through your own radio or as concealed telephone pickups. Useful replacements on battery-operated rural telephone lines.

THESE ARE GENUINE TRANSMITTERS, MADE BY KELLOGG, WESTERN ELECTRIC AND STROMBERG-CARLSON, excellent in appearance and operation. A remarkable value and one seldom offered in these times. Shp. Wt. 1 lb.  
ITEM NO. 160  
YOUR PRICE ..... **\$1.95**

## WATTHOUR METER



Completely overhauled and ready for immediate service. Designed for regular 110-volt, 60 cycle 2-wire A.C. circuit. Simple to install; 2 wires from the line and 2 wires to the load. Sturdily constructed in heavy metal case, 8 1/2" high, 6 1/4" wide, 5" deep. Besting-house, G. E. Ft. Wayne, Indiana, or other available make Shp. Wt. 14 lbs.  
ITEM NO. 33  
YOUR PRICE ..... **\$6.50**

## AMAZING BLACK LIGHT!!

Powerful 250-Watt Ultra-Violet Source



The best and most practical source of ultra-violet light for general experimental and entertainment use. Makes all fluorescent substances brilliantly luminescent. No transformers of any kind needed. Fits any standard lamp socket. Brings out beautiful opalescent hues in various types of materials. Swell for amateur parties, plays, etc.; to obtain unique lighting effects. Bulb only. Shp. Wt. 2 lbs.  
ITEM NO. 87  
YOUR PRICE ..... **\$2.50**

## WESTERN ELECTRIC BREAST MIKE

This is a fine light-weight aircraft carbon microphone. It weighs only 1 lb.

Mike comes with breastplate mounting and has 2-way swiveling adjustment so that it can be adjusted to any desired position. There are 2 wooden straps; one goes around neck, the other around chest. Straps can be snipped on and off quickly by an ingenious arrangement.

This excellent mike can be adapted for home broadcasting or private communication systems. By dismounting breastplate, it can be used as desk mike.

Comes complete with 6-foot cord and hard rubber plug. Finished in sinterized porcelain, non-rustable. Shipping weight, 2 lbs.  
ITEM 152  
YOUR PRICE ..... **\$1.49**



## HUDSON SPECIALTIES CO.

40 West Broadway, Dept. RC-8-48, New York 7, N. Y.

I have circled below the numbers of the items I'm ordering. My full remittance of \$..... (include shipping charges) is enclosed (NO C.O.D. ORDERS UNLESS ACCOMPANIED WITH A DEPOSIT) OR my deposit of \$..... is enclosed (200% required), ship order C.O.D. for balance. NO C.O.D. ORDER FOR LESS THAN \$5.00. BE SURE TO INCLUDE SHIPPING CHARGES. Circle Item No. wanted:

147 159 160 87 152 33

Name .....  
Address ..... Please Print Clearly  
City ..... State .....

# Radio Thirty-Five Years Ago

In Gernsback Publications

## HUGO GERNSBACK

Founder

Modern Electrics	..... 1908
Electrical Experimenter	..... 1913
Radio News	..... 1919
Science & Invention	..... 1920
Radio-Craft	..... 1929
Short-Wave Craft	..... 1930
Wireless Association of America	..... 1908

Some of the larger libraries in the country still have copies of ELECTRICAL EXPERIMENTER on file for interested readers.

FROM THE ELECTRICAL EXPERIMENTER, JULY, 1914

- The Speaking Arc Light by *H. Winfield Secor*
- Radio Transmission and Weather by *A. A. Taylor*
- Progress in Radiotelegraphy
- A Vacation Radio Pocket Set by *Harry V. Johnson*
- A Novel Detector Switch by *Albert St. Cyr*
- A Loop Aerial Switching Scheme by *Thomas Benson*
- Experimental Radio Station by *C. F. Hancock*
- Poulsen Receiving Sets
- Microphone Transmitters

FROM THE AUGUST 1914 ISSUE

- An Efficient Wavemeter by *Thomas W. Benson*
- Selenium Cells and How to Use Them
- Amplifier for Wireless Signals
- Wireless Receivers (A Symposium)
- A Variable Condenser by *Irving Byrnes*
- A Peroxide of Lead Detector by *James L. Green*
- A High Frequency Sending Buzzer by *Thomas W. Benson*
- Automatic Radio Tuning Device
- A New Low Altitude Antenna

## SPEAKER DEMONSTRATOR



Output of the receiver at top of this speaker demonstrating board can be channelled to any of the speakers. The board is made by Wright.

TV RECEIVER HAS MIRROR



This Sightmaster receiver looks like a period furniture piece with a mirror when it is not in use. When the false drawer front is folded down, the controls are revealed. The picture on the face of the cathode-ray tube is seen through the mirror which is transparent and acts as a filter to reduce eye fatigue.

NEW TUBE TYPES

Two new miniature electronic tubes, types 6AV6 and 12AV6, have been made available by General Electric. Providing an amplification factor of 100, they are designed for use as combined diode detectors, a.v.c. tubes, and first audio amplifiers.

The tubes are intended to supersede the 6AT6 and 12AT6 and may be substituted directly for them in receivers.

Both types are duplex-diode triodes, having triode sections capable of providing large undistorted output voltages from a small input signal. Heater voltage of the 6AV6 is 6.3 volts, while that of the 12AV6 is 12.6 volts.

NEW PARTS GUIDE OUT

A new parts replacement manual, the Howard W. Sams *Radio Industry Red Book*, will permit the repair technician to find instantly not only the manufacturer's part number for a component, but also a number of alternates. Unlike earlier encyclopedias which showed only one correct replacement, this guide gives the original part number plus three alternates for transformers, four for capacitors, two for controls and speakers, and one for i.f. coils, vibrators, batteries and phono pickup cartridges.

Radar will be installed on all 21 tankers of the Atlantic Refining Co. The operation is expected to take a year and to cost \$304,000.

A new optical radar unit is used in surveying. Pulses of light are reflected from the point whose position is to be determined. Distance is measured by the time taken for the light to travel.

Interference to aviation radio on the 6-mc band which was noted from Oregon to Puerto Rico and far east into the Atlantic has been traced to an electronic heater in a Johnstown (Penna.) chair manufacturing plant.

AUGUST, 1948

We're GILDING the LILY!

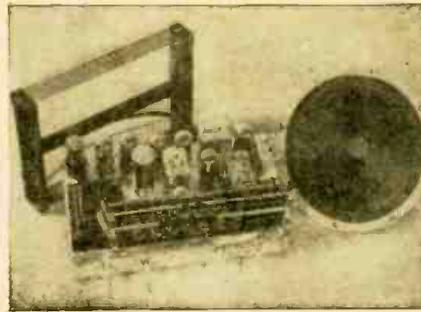

The

NEW, IMPROVED Model 7-B-1, engineered to meet YOUR needs!

Carefully engineered, and manufactured of the finest materials, the ESPEY Model 7-B-1 is specifically designed to meet the most exacting requirements for a replacement chassis, and will lend itself to any type of installation. This model is drift-compensated, AM/FM, with 10 tubes plus rectifier. Supplied complete, ready to operate.

Send to DEPT. C-8 TODAY for FREE LITERATURE



"ESTABLISHED - 1928"

Do you need BINDING POSTS?



The XL PUSH POST with its Spring Action assures Constant Contact and quiet connection. Manufactured in All Aluminum Type M at \$2c each. Aluminum Body, Bakelite Top Type B1 at 15c each. Types CP or NP. ALL BRASS-STAINLESS STEEL SPRING & PIN. PROVEN by 240 HR. SALT SPRAY TEST as NON-CORROSIVE at 28c each.

Manufacturers and Dealers Liberal Discounts

X. L. RADIO LABORATORIES 420 West Chicago Ave., Chicago 10, Ill.



FREE!

It's nearly ready... the new, bigger, better-than-ever Walter Ashe Catalog of Radio and Electronics for 1949!

For "priority" delivery, reserve your free copy of this helpful, informative buying guide now. Simply write: "1949 Catalog on a penny post card. Sign your name and address. Mail to..."

WALTER ASHE RADIO CO. 1325 PINE ST. ST. LOUIS 3, MO.

PLEASE TEAR OUT THIS ADV. AS REMINDER

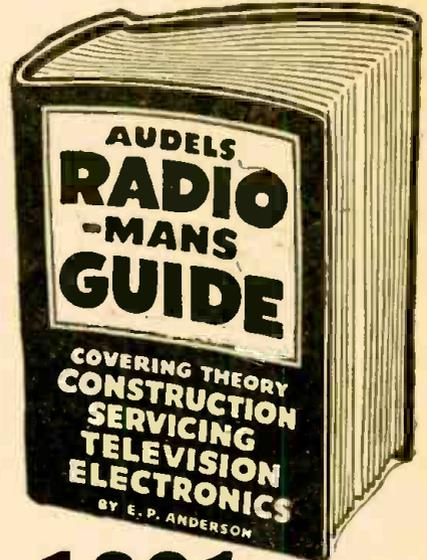

1001 RADIO FACTS AND FIGURES

AUDELS RADIOMANS GUIDE—914 Pages, 633 Illustrations, Photos, Wiring Diagrams, 88 Big Chapters, covering Radio Theory, Construction, Servicing, Including Important Data on Developments in Television, Electronics and Frequency Modulation, Review, Questions and Answers, Calculations & Testing, Highly Endorsed—Indispensable for Ready Reference and Home Study.

\$4 COMPLETE • PAY ONLY \$1 A MONTH Step up your own skill with the facts and figures of your trade. Audels Mechanical Guides contain Practical Inside Trade Information in a handy form. Fully illustrated and Easy to Understand. Highly Endorsed. Check the book you want for 7 days' Free Examination.

Send No Money. Nothing to pay postman.

CUT HERE MAIL ORDER

AUDEL, Publishers, 49 W. 23 St., NEW YORK 10, N. Y.

Please send me postpaid for FREE EXAMINATION books marked (x) below. If I decide to keep them I agree to mail \$1 in 7 days on each book ordered and further mail \$3 monthly on each book until I have paid price—otherwise, I will return them.

- RADIOMANS GUIDE, 914 Pages . . . \$4
- ELECTRICIANS EXAMINATIONS, 250 Pages . . . 1
- WIRING DIAGRAMS, 210 Pages . . . 1
- ELECTRIC MOTOR GUIDE, 1000 Pages . . . 4
- ELECTRICAL DICTIONARY, 9000 Terms . . . 2
- ELECTRICAL POWER CALCULATIONS, 425 Pgs. . . 2
- HANDY BOOK OF ELECTRICITY, 1440 Pages . . . 4
- ELECTRONIC DEVICES, 216 Pages . . . 2
- ELECTRIC LIBRARY, 12 vol., 7000 Pgs., \$1.50 vol. . . 1
- OIL BURNER GUIDE, 384 Pages . . . 1
- REFRIGERATION & Air Conditioning, 1280 Pgs. . . 4
- POWER PLANT ENGINEERS Guide, 1500 Pages . . . 4
- PUMPS, Hydraulics & Air Compressors, 1658 Pgs. . . 4
- WELDERS GUIDE, 400 Pages . . . 1
- BLUE PRINT READING, 416 Pages . . . 2
- SHEET METAL WORKERS Handy Book, 388 Pgs. . . 1
- SHEET METAL PATTERN LAYOUTS, 1100 Pgs. . . 1
- AIRCRAFT WORKER, 240 Pages . . . 1
- MATHEMATICS & CALCULATIONS, 700 Pgs. . . 2
- MACHINISTS Handy Book, 1600 Pages . . . 4
- MECHANICAL Dictionary, 968 Pages . . . 4
- AUTOMOBILE GUIDE, 1700 Pages . . . 4
- DIESEL ENGINE MANUAL, 400 Pages . . . 2
- MARINE ENGINEERS Handy Book, 1280 Pages . . . 4
- MECHANICAL DRAWING GUIDE, 160 Pages . . . 1
- MECHANICAL DRAWING & DESIGN, 480 Pgs. . . 2
- MILLWRIGHTS & Mechanics Guide, 1200 Pgs. . . 4
- CARPENTERS & Builders Guides (4 vols.) . . . 6
- PLUMBERS & Steamfitters Guides (4 vols.) . . . 6
- MASONS & Builders Guides (4 vols.) . . . 6
- MASTER PAINTER & DECORATOR, 320 Pgs. . . 2
- GARDENERS & GROWERS GUIDES (4 vols.) . . . 6
- ENGINEERS and Mechanics Guides . . . 1
- Nos. 1, 2, 3, 4, 5, 6, 7 and 8 complete . . . \$12
- Answers on Practical ENGINEERING . . . 1
- ENGINEERS & FIREMANS EXAMINATIONS . . . 1

Name \_\_\_\_\_  
 Address \_\_\_\_\_  
 Occupation \_\_\_\_\_  
 Employed by \_\_\_\_\_ R.C.F.

# WANTED Your Name

on our mailing list to receive our  
**FREE MONTHLY BULLETIN**  
listing hundreds of outstanding  
radio bargains.

To get your name, your address, RSE offers

## MIDGET I.F. TRANSFORMERS

Back again—by popular demand!



RSE scores again with a new and better I. F. J. 400-500 KC range—1 1/4" square x 3" high—ceramic based micro trimmers—high gain iron cores—pep up old receivers, ideal for new construction—and now available in either input or output types—for peak performance! Individually boxed in the colorful RSE carton. List price \$2.10. LR1—input; LR2—output.

Specify Type.

Each	Matched Pair	Dozen	Egg Crate of 100
36c	69c	\$3.95	\$29.00



## VOLUME CONTROLS

• Our own private brand—made by a nationally known manufacturer. • The same kind that net for \$1.09. • Noise-free carbon construction, standard shaft and bushing. • Individually boxed in our colorful carton carrying the RSE quality seal of approval. • Complete with switch, full range of sizes.

10 M ohms	100 M ohms	each	59c
15 M ohms	250 M ohms	per 10	\$5.50
25 M ohms	500 M ohms	ass'd.	
50 M ohms	1 Meg ohms		
2 Meg ohms			
500 M Knurled Shaft			
500 M ohms less switch, 39c each, 100 for \$35.00			

## PHONO CABINET



Used in the Zenith "Cobra Tone Arm" record demonstrators. Solidly built of 3/4" plywood covered with maroon luggage cloth. 14" x 16" square, 11" high. Flocked grill for 8" speaker. Rubber mounting feet, ventilated rear cover. Brand new in factory cartons. Every record and radio shop can use these!

\$2.99

## PHONO AMPLIFIER

A high quality AC-DC phono amplifier featuring the latest circuits and tubes. The chassis is only 2" x 2 1/4" x 5 1/2" and includes volume and tone controls, built-in output transformer, and 5' rubber line cord. Complete with 35W4 and 50B5 tubes. Operates on 110 to 120 volts AC or DC. Supply is limited—first come first served



\$4.19

**OZ4'S**  
at 73% OFF!

Until sold out—RSE offers 15000 new guaranteed OZ4 tubes. You know who made them—You can't go wrong at

59c



## ORDER INSTRUCTIONS

Minimum order—\$2.00. 25% deposit with order required for all C.O.D. shipments. Be sure to include sufficient postage—express will be refunded. Orders received without postage will be shipped express collect. All prices F.O.B. Detroit.

DEMAND THIS SEAL OF QUALITY

**RADIO SUPPLY & ENGINEERING CO., Inc.**  
125 SELDON AVE. DETROIT 1, MICH.

# REVOLUTIONARY NEW AMPLIFIER

NOW AVAILABLE!

It's cleverly designed to defy obsolescence, and it's sensational in performance! New circuits . . . new materials . . . new processes, are combined in this amazing instrument, to produce the MOST SATISFYING sound amplifier the world has ever known. If you are one of those discriminating persons for whom anything less than the best is a disappointment—the ACA-100 was designed for YOU!



**AMPLIFIER CORP. OF AMERICA**  
398-10 Broadway New York 13, N. Y.

## 1948 MODEL MUTUAL CONDUCTANCE TUBE TESTER

with new 9 pin socket to handle all future tube developments . . . \$49.95

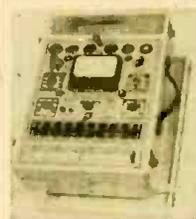

No possibility of good tubes reading "Bad" or bad tubes reading "Good" as on dynamic conductance testers or other ordinary emission testers. "Attractive panel and case equal to any on the market in appearance . . . Large 4 1/2" meter. . . . Calibrated micromho scale as well as a Bad-Good scale . . . Front panel fuse. . . . Individual sockets for all tube base types—voltages from .75 volts to 117 volts and complete switching flexibility allow all present and future tubes to be tested regardless of location of elements on tube base. . . . Indicates gas content and detects shorts or opens on each individual section of all octal, octal and miniature tubes including cold cathode, magic eye and voltage regulator tubes as well as all ballast resistors. Name of the nationally known manufacturer withheld because of special price offer.

Model "C"—Sloping front counter case \$49.95  
Model "P"—Handsome hand-rubbed portable case . . . . . \$4.95  
Built-in-roll chart with either of above \$5.00 extra.

**BUFFALO RADIO SUPPLY**  
219-221 GENESEE STREET BUFFALO 3, N. Y.  
DEPT. BC

## • TEST-AID • FIRST-AID FOR RADIO-TELE SETS

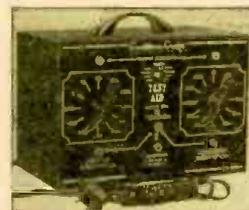

ONLY  
**\$15.95**

COMPLETE  
•  
WRITE FOR CATALOG SHEET

- QUICKLY LOCATES FAULTY CONDENSERS AND RESISTORS FOR FAST SERVICING
- SUBSTITUTES 11 DIFFERENT VALUES OF CAP. OR RES. WITH SET IN OPERATION 50mmf to 40mfd 450-600 WVDC—27 ohms to 5 mhu.
- CHECKS CONDENSER LEAKAGE ON DIRECT CURRENT SUPPLIED FROM OWN PWR SUP.
- OUTPUT INDICATOR FOR ALIGNMENT—CONTINUITY CHECKS
- PROVIDES 100 VOLTS AT 100 MA FOR EXPERIMENTS.

These are only a few of the many uses of the TEST-AID. See them at your dealer or write us direct.

256 E. 98th STREET, BKLYN, N. Y.

## WELL-BALANCED MAGAZINE

Dear Editor:

I don't think you can ever please everybody with the articles you publish. But here is my opinion:

I don't agree with those readers who want RADIO-CRAFT to stick to simple educational material. You can buy any number of books on elementary radio and electronics. I'm completely new in the field, so I want to know how the simple devices work. But I also want to know how the more elaborate circuits are made. Print both simple and complex articles, and give newcomers like me a chance to progress.

True, I haven't built the 17-tube FM receiver (RADIO-CRAFT, November, 1947), but I have made a note of it. When I get around to fooling with FM, I will look it over and maybe use all or part of it.

I finished an 18-tube, 4-band AM set about four months ago, and you can bet I got circuits and ideas from RADIO-CRAFT, from both the simple and the advanced articles.

In short, a newcomer always finds plenty in RADIO-CRAFT that he can understand and plenty of material that will allow him to increase his knowledge. I think your magazine is well-balanced for the majority of the readers.

C. O. SUTTON,  
Alameda, Calif.

## EUROPEAN EQUIPMENT

Dear Editor:

Orchids to Maj. Hallows! It was a great satisfaction to me to read his report that there had been some improvement in European receiver design. During my three war years in the Middle East, I worked on practically every well-known European brand, and I do mean worked. A serviceman must be a mechanical engineer and a jigsaw-puzzle expert to cope with the array of cams, levers, friction clutches, and push-buttons on some of these sets.

Please give us more articles by Maj. Hallows on foreign receivers. Maybe our own manufacturers can get some ideas. We're far from perfect.

EUGENE K. GOODWIN,  
Los Angeles, Calif.

## IGNITION RUINS FM?

Dear Editor:

I certainly agree that FM is superior to AM in some cases but it is not free from noise caused by automobile ignition systems. Automobile noise in some locations ruins FM reception.

Is anyone doing anything about this? I wish RADIO-CRAFT would print an article on how to solve the problem.

LOUIS ZARATTARO,  
Pittsfield, Mass.

(Are many listeners plagued with this problem? Are some locations actually impossible for FM reception or were Mr. Zarattaro's experiences with poor receivers? Reports from other readers on this subject should be interesting, especially if make of receiver is noted, along with details about the antenna location with relation to, automobile traffic.—Editor)

**CONTROLS FOR REPAIRMEN**

Dear Editor:

Federal control of radio operators and transmitters has been of great help in assuring operation for the benefit of the public. I do not believe, however, that the government should license radio repairmen.

It would be more constructive to form a union of servicemen. This organization would issue its own technical certificates, based on standardized examinations of prospective entrants into the profession. The standards might be set up by the IRE, for example, as an outstanding independent engineering organization. Several organizations might be set up, if territorial or other reasons should make it desirable, all using the common set of standards. This would certainly help to strengthen radio servicing as a profession, rather than a hazardous affair.

SYLVESTER ROBINSON;  
Kansas City, Mo.

**SUB-MINIATURE TUBES**

Dear Editor:

We were most interested in the electronic stethoscope on page 66 of the June issue of RADIO-CRAFT.

The item stated that a CK510AX could be substituted for the first CK512AX if added gain were desired. We would like to remind constructors that a direct substitution is impossible without certain changes. In the diagram the two CK512AX filaments are in series; since the CK510AX requires 2½ times as much filament current as the CK512AX, this will have to be changed. In addition, a different socket is required if sockets are used.

C. W. MARTEL,  
RAYTHEON MFG. Co.,  
Newton, Mass.

**LIKES THE NEW LOOK**

Dear Editor:

Again Gernsback leads the field in foresight and imagination. Your new format is certainly a boon to radiomen. Digging for a particular article will no longer be a chore but a pleasure. That "continued on page . . ." will no longer plague busy technicians. *Congratulations!*

I disagree with one point in Mr. Sanabria's letter published on page 82 of the June RADIO-CRAFT. There is not really a shortage of technicians for FM and TV servicing. The fact is that the industry will not hire inexperienced men.

Radio schools can only train men, not give them experience. If no one will hire them, they will never get experience. It is the old vicious circle: inexperienced men can't get a job, but if they don't work they can't get experience.

It is up to the radio industry to give these men a chance. If it does, there will not be a shortage of technicians for long.

PHILLIP SPAMPINATO,  
New York, N. Y.

**Radio - Television - Electronic  
Parts & Equipment Specials**

**TELEVISION-CATHODE RAY HIGH  
VOLTAGE**

**2000 volt D.C. Power Supply**  
For an unbelievably low price, we can supply a completely filtered television or cathode ray 2000 volt D.C. power supply. Why bother with bulky and dangerous 60 cycle supplies or expensive R.F. power supplies when you can purchase a complete 2000 volt D.C. unit (not a kit), ready to plug into the 110 volt A.C. power line. The ridiculously low price has been made possible by a fortunate purchase of high quality components. These units are brand new, completely tested and guaranteed.

Price \$7.95

**4000-6000 VOLT TELEVISION SUPPLY**

Similar to the unit above, but has a much higher D.C. output voltage suitable for use with the new 7" and 10" television tubes.

PRICE ..... \$12.50

**MALLORY RADIO NOISE FILTERS**

Eliminates extremely noisy radio reception due to power line disturbances caused by lights, refrigerators, washing machines, vacuum cleaners, elevators, oil burners, diathermy machines, etc.

Filters out man-made noises in the broadcast, short-wave, and ultra-high frequency bands.

Designed for all radios, appliances, and electrical equipment consuming up to 1300 watts (12 amperes) at 120 volts AC or DC.

Housed in a metal case 1½" x 3" x 7½" complete with male and female line connectors.

PRICE ..... ONLY \$1.95

Industrial Type Radio Noise Filter—Will handle up to 50 amperes. Housed in shielded case 3¾" x 3¾" x 2½".  
PRICE ..... \$3.95

**EASILY ASSEMBLED RADIO KITS**

5 Tube AC-DC superhet kit furnished in a brown plastic cabinet of artistic design, cabinet size (9"x5"x6")

Variable condenser tuned; with 2 double tuned I. F.'s.

Tubes used: 1-12SA7, 1-12SQ7, 1-12SK7, 1-35Z5 and 1-50L6.

PRICE \$11.95 including 5 standard tubes

**6 TUBE 3 WAY PORTABLE KIT**

• For operation on 110 volt AC or DC and battery

• Superheterodyne circuit

• Full vision dial

• High gain loop

• Cabinet of Blue Aeroplane cloth finish, size 13x9¾x7"

• Tubes used 1A7, 1H5, 3Q5, 117Z6 and 2-1N5

PRICE \$13.75 Not including tubes Extra for kit tubes \$3.75

**6 TUBE, 2 BAND SUPERHET KIT**

Bands covered BC 550-1600 KC and 6-18 MC

Power supply 105-125V AC, DC

Full vision dial

Variable condenser tuned, with two double tuned I. F.'s 455KC

Walnut veneer wood cabinet

PRICE \$15.75

**A SCIENTIFICALLY DESIGNED  
PHONO SCRATCH FILTER**

Resonated at approximately 4500 cycles effectively reducing objectionable needle scratch without altering the brilliancy of reproduction.

Contains a HI-Q SERIES resonated circuit. Tested by means of an audio oscillator and an oscilloscope to give 22 db. attenuation with very low signal loss. Attenuation may be regulated by means of a SPECIAL MINIATURE gain control.

EASY TO ATTACH

Just two wires to clip on. Compact.

Price ..... \$1.65

**THREE TUBE PHONO AMPLIFIER**

An assembled unit ready for installation using tone and volume control and six feet of rubber cord

(Not including Tubes) ..... \$2.95

With Complete Set of Tubes ..... \$3.95

**PHONO OSCILLATOR**

Wireless phono oscillator transmits recording for crystal pick-ups or voice from carbon mike through radio without wires. Can also be used as an intercomm by using P.M. speaker as mike. Price

(excluding tubes) ..... \$2.95

With Complete Set of Tubes ..... \$3.95

**SPECIAL! SPECIAL!**

Mammoth assortment of radio and electronic parts, not less than TEN POUNDS of new transformers, chokes, condensers, resistors, switches, coils, wire, hardware, etc. A super-buy for experimenters, servicemen, and amateurs for only

..... \$1.25

Satisfaction guaranteed on all merchandise. All prices F.O.B. New York City

WRITE FOR FREE CATALOGUE

**RADIO DEALERS SUPPLY CO.**

135 Liberty St. New York, N. Y.

**30,000  
SUCCESSFUL  
RADIO SERVICE-  
TECHNICIANS READ**



**EVERY MONTH**

RADIO MAINTENANCE today fills a breach that has existed in the radio field for a long time. Already 30,000 technicians read RADIO MAINTENANCE every month because it is devoted entirely to the Radio Serviceman.

The RADIO MAINTENANCE staff specializes in the preparation of articles on every phase of Radio Maintenance in series form which may be filed and used for reference. The leading articles cover everything for the radio serviceman on Television, FM and AM; Test Equipment; Electronic Appliances; Tools; Antennas; Alignment; Troubleshooting; Repair; Construction; Pick-ups and Sound Amplification and Reproduction Equipment. Also, in RADIO MAINTENANCE each month there are departments on hints and kinks, the latest news of the trade, review of trade literature, radiomen's opinions, new products and news from the organizations. All articles are presented in a step-by-step precision style, clearly illustrated, with schematics, accurate photographs, specially prepared drawings, white on black charts, color diagrams, isometric projections and exploded views.

Binders in beautiful green simulated leather are now available for your RADIO MAINTENANCE magazines—see the current issue for details.

**RADIO MAINTENANCE MAGAZINE RC8**

460 Bloomfield Avenue,

Montclair 6, N. J.

Please send me RADIO MAINTENANCE for

2 years, \$5  1 year, \$3

Payment enclosed  Bill me later

Name .....

Address .....

City—State .....

\*Occupation .....

Title .....

Employed by .....

\*Independent Serviceman — Dealer Serviceman—

Service Manager—Dealer—Distributor—Jobber.

**BOLAND & BOYCE INC., PUBLISHERS**

# BUFRAD CAR RADIO ANTENNAS

All of our car radio antennas are made of triple plated Admiralty Brass Tubing, complete with low loss shielded antenna leads and high quality fittings.

**SIDE COWL—BR-1**, 3 sections extend to 66". Your price—single units—\$1.50; in lots of 12—\$1.35 ea.

**SKYSCRAPER—BR-2** has 4 heavy duty sections that extend 98". This super-aerial must be seen to be fully appreciated. Your price—single units—\$2.45; in lots of 12—\$2.25 ea.

**TILT ANGLE—BR-3**, may be adjusted to all body contours, 3 sections extend to 66". Single unit price—\$1.50; 12 lot price—\$1.25 ea.

**VERSATILE—BR-4**, single hole fender or top cowl mounting may be adjusted to conform with all body contours, 4 sections extend to 66". Single unit price—\$2.90; 12 lot price—\$2.75 ea.

**THE MONARCH—BR-5**, single hole top cowl mounting, 3 sections extend to 66". Single unit price—\$1.90; 12 lot price—\$1.75 ea.

**AFTER SEEING OUR ANTENNAS AND COMPARING, YOU WILL NEVER BUY ANY OTHER MAKE!**

**BENDIX SCR 522**—Very high Frequency Voice Transmitter-Receiver—100 to 156 MC. This job was good enough for the Joint Command to make it standard equipment in everything that flew, even though each set cost the Gov't \$2500.00. Crystal Controlled and Amplitude Modulated—**HIGH TRANSMITTER OUTPUT** and 3 Microvolt Receiver Sensitivity gave good communication up to 180 miles at high altitudes. Receiver has ten tubes and transmitter has seven tubes, including two 832's. Furnished complete with 17 tubes, remote control unit, 4 crystals, and the special wide band VHF antenna that was designed for this set. These sets have been removed from unused aircraft and are guaranteed to be in perfect condition. We include free parts and diagrams for the conversion to "continuously variable frequency coverage" in the receiver.

The SCR 522 complete with 24 volt dynamotor sells for only \$37.95. The SCR 522 is also available with a brand new 12 volt dynamotor for only \$42.95.

## BUFFALO RADIO SUPPLY

219-221 GENESEE STREET, BUFFALO 3, N. Y. DEPT. 8C

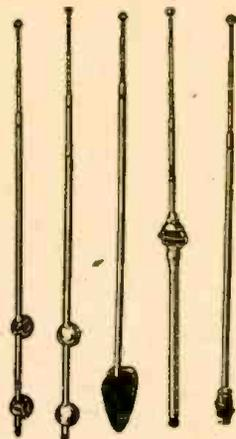

BR1 BR2 BR3 BR4 BR5

### All-Purpose WAR SURPLUS

## AVIATION GENERATOR

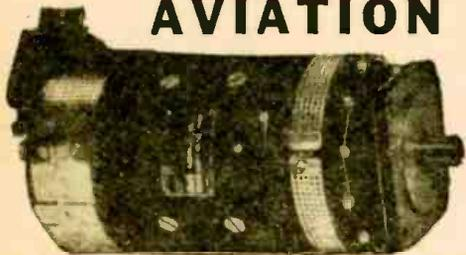

Ideal for Radio Generator, Battery Charging and many other uses.

Original Cost \$170.00 Each **\$19.95 EACH**

Cash or Check with order prepaid in U.S.A. Net weight 34 lbs. Ship wt. 50 lbs.

- Made by Eclipse Pioneer, Div. of Bendix Aviation
- Type 314 Model 31 Style A
- Guaranteed BRAND NEW Perfect
- 30 Volt 50 Ampere 1500 Watt
- Length 14", Diameter 6"
- 7/8 O.D. 1" length shaft
- Packed in original crates
- Min. R.P.M. 2600, Max. R.P.M. 4000

**NORTH AMERICAN SALES, INC.** Dept CR 8 SO. DEARBORN ST. CHICAGO 3, ILL.

**ADVANCED RADIO SERVICING.** Methods and Ideas. A collection of lectures by M. N. Heitman. Supreme Publications. 8 1/4 x 10 1/2 inches, 224 pages. Price \$3.00.

The series is divided into three sections, dealing with the business side of radio servicing, equipment used, and radio circuits and trouble-shooting.

Some interesting layouts of shops appear in the first section. The descriptions of radio equipment, however, form the most interesting part of the book. A large number of modern test instruments are discussed with complete schematics and technical details. The typography is largely typewriter style, though some chapters are printed in standard type.

**RADIO DATA BOOK.** edited by William F. Boyce and Joseph J. Roche. Published by Boland and Boyce, Inc. 5 x 7 inches, 1148 pages. Price \$5.00.

Subject matter is divided into ten sections: basic circuits; test equipment; tests and measurements; antennas; sound systems; sound recording; tube data; formulas, graphs and tables; symbols, codes and standards; circuit diagrams; radio dictionary; and radio books (bibliography).

Most interesting section is the basic circuits, which number nearly 150, ranging from crystal detectors to Klystron oscillators. Possibly equally valuable is the large section of formulas, graphs and tables, which contain much of the reference data every radioman must seek from time to time.

The section on tests and measurements contains basic descriptions of the methods of measuring most electronic quantities. An interesting feature is the fairly large number of oscilloscope patterns. The tube data section lists important transmitting and receiving types.

**ELECTRONIC TRANSFORMERS AND CIRCUITS.** by Reuben Lee, Advisory Engineer, Westinghouse Electric Corp. Published by John Wiley & Sons, 6 1/4 by 9 1/4 inches, 282 pages, cloth covers. Price \$4.50.

The author has covered the many new problems confronting the designer of electronic transformers with formulas and graphs, and where necessary has included the associated circuits.

The first sections deal with core materials and windings, dielectric strength of insulating materials, impregnation, and size vs. rating, etc. Then follow discussions on rectifier transformers and reactors, voltage doublers, anode and filament transformers.

The action of polyphase rectifiers and multistage filters is discussed; also tuned rectifier filters, amplifier transformers, anode characteristics and low-frequency response, harmonic distortion, pentode amplifiers, and amplifier transformer design.

Later chapters deal with wave filter principles, modulation transformers, driver transformers, iron- and air-core transformers, grid-controlled rectifiers, saturable reactors, and peaking transformers. Other subjects include pulse and video transformers, design of pulse transformers, saw-tooth transformers, testing technique, etc. A valuable appendix containing useful formulas is included, also a bibliography on the subject and a well-arranged index.—H.W.S.

## Get Started in Radio

10 "HOW-TO-DO-IT" BOOKS



Get a solid foundation in radio by means of these 10c timely text books. Each clearly written, profusely illustrated, contains over 15,000 words. You'll be amazed at the wealth of information packed into these handy books. Excellent for reference—ideal for technical library. Your money back if not satisfied.

5 BOOKS for 50c  
10 BOOKS for \$1.00  
Sent to You Postpaid

- |  |                                     |
|--|-------------------------------------|
| No. 1—How To Make Four Doerle Short Wave Sets                      | No. 6—How To Have Fun With Radio    |
| No. 2—How To Make The Most Popular All-Wave 1 and 2 Tube Receivers | No. 7—How To Read Radio Diagrams    |
| No. 3—Alternating Current for Beginners                            | No. 8—Radio for Beginners           |
| No. 4—All About Aerials  | No. 9—Simple Electrical Experiments |
| No. 5—Beginners' Radio Dic.  | No. 10—Television                   |
- Remit by check or money order—register letter if you send cash or stamps.

### RADIO PUBLICATIONS

25A West B'way, New York (7)

**RADIO-CRAFT** needs more photos of service shops and service benches. We will pay \$6.00 for each 6x8- or 8x10-inch glossy photo accepted. Do not "dress up" your bench, but take a bona-fide photo, preferably with men working.

## AMSCO'S AUGUST SPECIALS

### BUILD YOUR OWN 6-TUBE SUPERHETERODYNE RECEIVER

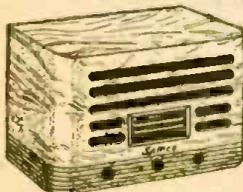

AC-DC 6 tube super-het. 2 band receiver... slug tuning. We furnish all parts less tubes.

**\$8.95**

### PARABOLIC REFLECTORS

15" spun aluminum Alzak fin. for 1200 Mc. Up **\$3.00**

MICRO WAVE TUBE WE713A **\$3.95**

S14 G.E. GLOW LAMPS. . . Can be used for nite-lights. Box of 10 **\$2.49**

MASTER CONTROL FOR RADIO COMPASS-ARN7. Complete with meter. NEW **\$1.39**

300 OHM TWIN LEAD WIRE . . . per 100 ft. **\$2.75**

### TRANSFORMERS

Tapped Primary 110V-118V-120V-126V-132V-138V-145V-60 cycle. Secondary 22.3 Volt 10 Amp. . . . . Brand New **\$2.89**

Available 1948 CATALOG Write Today

### AMERICAN SALES CO.

1811 W. 47th St. Chicago 9, Ill.

**RADIO ENGINEERING**, by Frederick Emmons Terman. Third edition. Published by McGraw-Hill Book Co. 6 1/2 x 9 inches, 969 pages, plus prefaces and contents. Price \$7.00.

The standard radio engineering text has been revised completely and is in all respects a 1948 work. The older chapter on resonant circuits has been expanded into two—one dealing with lumped and the other with distributed constants. Under Electron Tubes are found such subjects as electron optics and high-frequency and transit-time effects. Amplifiers include the travelling-wave tube. Klystrons and magnetrons are discussed under Oscillators. Frequency modulation, crystal detectors and mixers, and u.h.f. antennas are given space commensurate with their present-day importance and radio navigation aids (chiefly radar) and television receive a chapter each.

**APPLIED ARCHITECTURAL ACOUSTICS**, by Michael Rettinger. Published by Chemical Publishing Co. Stiff cloth covers, 5 1/2 x 8 1/2 inches, 189 pages. Price \$5.50.

In a practical, concise handbook written for both the architect and sound engineer Mr. Rettinger presents material covering the general design of buildings or rooms in which correct acoustical conditions are of prime importance. Theoretical as well as practical aspects have been considered, making this book also suited as a text book.

The first three chapters deal with geometric acoustics, reverberation, and sound insulation. Chapters bear such headings as "Motion Picture Theaters," "Broadcasting Studios," etc.

*Applied Architectural Acoustics* is a well written volume packed with hard-to-find information that otherwise could be found only by a frustrating search through more voluminous works. Even the nontechnical public address serviceman should find the wealth of rule-of-thumb information invaluable in installing sound systems.—E.B.

**RADIO TEST INSTRUMENTS** (revised edition), by Rufus P. Turner. Published by Ziff-Davis Publishing Co. 6 1/4 x 9 1/2 inches, 221 pages. Price \$4.50.

The author describes the construction of more than 75 separate pieces of radio test equipment including volt-ohm-milliammeters; vacuum-tube voltmeters; watt, decibel, impedance, capacitance, and inductance meters; oscilloscopes and accessories; special-purpose bridges; a.f. and r.f. signal generators; frequency meters; and signal tracers. A few of these devices have been described in past issues of *RADIO-CRAFT* and *RADIO NEWS*. Photographs and drawings show parts layouts and mechanical construction of the more complex items. Methods of adjusting, calibrating, and operating the instruments are described.

Errors were noted in three of the oscilloscope diagrams. Cathode returns were omitted from the C-R tube circuits.—R.F.S.

**ELECTRONIC CIRCUITS AND TUBES**, by the Electronics Training Staff of the Cruft Laboratory, Harvard University. Published by McGraw-Hill Book Co. 6 1/2 x 9 inches, 948 pages. Price \$7.50.

The material presented was taken from notes prepared for lectures given at the Graduate School of Engineering at Harvard University during the war. (Continued on page 87)

Aluminum gear box 18x8x7 that contains two powerful electric motors and two matched gear trains, 62 gears in all varying in size from 1/2 to 4 inches in diameter. This unit is readily converted to rotate a beam antenna or any other similar use. . . . \$3.00  
**TUBES**—All types in stock, 60% off on all tubes if ordered in lots of 10 or more.

**TRANSFORMERS**—All types in stock. **AUTO-TRANSFORMERS**: Steps up 110v, or steps down 220v to 110v—\$1.95.

**FIL. TRANS.**: 6.3v, 20 Amps.—\$1.98; Universal Output Trans. 8 Watt—89c; 18 Watt—\$1.29; 30 Watt—\$1.69. **AUDIO TRANSFORMERS**: S. Plate to S. Grid. 3:1—79c; S. Plate to P. Grids—79c; Heavy Duty Class AB or B. P.P. Inputs—\$1.49; Midget Output for AC-DC sets—69c. **MIKE TRANSFORMER** for T-17 Shure microphone, similar to UTC output type—\$2.00. Stancor SB or DB mike to line or grid—\$1.95.

**POWER TRANSFORMERS**—Half-shell type, 110V, 60 cy. Centertapped HV windings. Specify either 2.5 or 6.3V filament when ordering.

For 4.5 tube sets—650V, 40MA, 5V & 2.5 or 6.3V . . . . . \$1.49

For 5-6 tube sets—650V, 45MA, 5V & 2.5 or 6.3V . . . . . 1.75

For 6-7 tube sets—675V, 50MA, 5V & 2.5 or 6.3V . . . . . 1.90

For 7-8 tube sets—700V, 70MA, 5V & 6.3 or two 2.5V . . . . . 2.35

For 7-8 tube sets—700V, 70MA, 5V & 6.3 (25 Cycle) . . . . . 2.60

For 8-9 tube sets—700V-90MA, 5V-3A, 2.5V, 3.5A, 2.5-10.5A . . . . . 2.85

For 9-11 tube sets—700V, 5V & 6.3V-4A . . . . . 2.85

For 9-15 tube sets—800V, 180MA, 5V & 6.3V . . . . . 2.95

**CONDENSERS**—PAPER TUBULAR 600 WV.—001, 002, 003—8c; .01, .05—9c; .1—10c; .25—23c; .5—35c;

**ELECTROLYTICS**: 8mfd 200v—20c; 10mfd 95v—20c; 30mfd 150v—23c; 20/30mfd 150v 35c; 30/20 150v 46c; 50mfd 150v—43c; 8mfd 475v—34c; 10mfd 350v—65c; **OIL CONDENSERS**: 4mfd 600v—49c; 2mfd 600v—29c; 3X, 1mfd 600v—29c

**SPEAKERS**—These PM speakers are the finest that are available. All have heavy oversize Alnico V magnets.

2 1/2" . . . . . \$1.15 . . . . . 6 for \$6.60

3" . . . . . \$1.15 . . . . . 6 for \$6.60

4x6 (oval) . . . . . \$1.95 . . . . . 6 for \$11.40

6" . . . . . \$1.10 . . . . . 10 for \$9.50

7" (Car Radio Size) \$4.50 . . . . . 6 for \$21.50

8" . . . . . \$3.95 . . . . . 6 for \$20.50

10" . . . . . \$5.50 . . . . . 6 for \$30.00

12" . . . . . \$7.95 . . . . . 6 for \$42.00

**MIDGET 1 WATT RIG** supplied complete with polystyrene coil forms for 3 ham bands. Size overall, 3 1/2" x 2 1/2" high. Includes practically all necessary parts. Details on page 62 of January 1948 QST. Your cost . . . . . \$1.50

Battery pack for the 1 watt transmitter supplying 90 volts "B" and 1.5 volts "A" . . . . . \$1.50

110V. AC power supply kit for the 1 watt transmitter . . . . . \$3.50

**FILTER CHOKES**: 200, 300, 400, 800 ohm light duty—99c; 200 or 300 ohm heavy duty—99c; 250 ma 35 ohm made for U.S. Navy, fully shielded—\$1.95; 75 ohm 125ma—25c; or 25 for \$4.25; "Meissner type" tapped filter chokes—25c; Choke-condenser combination, ideal to replace any size speaker field when installing PM speaker—79c

**LINE FILTERS**—110V—each unit contains two 2 mfd. oil filled condensers and a 15 amp. iron core choke. This filter has innumerable uses such as oil burner line filter, etc. A ten dollar value for 99c.

**SELENIUM RECTIFIERS**—Dry disc type 1 1/2", 1.2 Amp. maximum, suitable for converting DC relays to AC, for supplying filament source in portable radios, convertink DC meters to AC applications, and also may be used in low current chargers—90c.

**3 MC I.F. TRANSFORMERS**, double slug tuned—25c.

**30 MC VIDEO AMPLIFIER PLATE COILS**—Slug tuned—25c.

**BUFFALO RADIO SUPPLY**

219-221 GENESEE STREET, BUFFALO 3, N. Y. DEPT. 8C

Prepare For A Good Job Now in  
**RADIO**  
 SOUND and TELEVISION

LEARN QUICKLY IN THE GREAT SHOPS OF  
**COYNE**

NOT A "HOME STUDY" COURSE  
 Get ready for a better job, bigger pay NOW in Radio. Cash in with "All-around" knowledge of Radio—Sound—Television. Train on actual equipment not by "Home-study". You learn quickest at COYNE because it's a real SHOP course!

**G.I. APPROVED** . . . also Finance Plan for NON-VETERANS. Don't let lack of cash hold you back. Many earn while learning. FREE Employment Service to graduates. Get facts today!

**SEND COUPON FOR FREE BOOK**  
 Send at once for Big Free Book on Radio, Sound and Television, and facts about our Finance Plan.

**MAIL THIS COUPON TODAY**

**B.W. COOKE, Pres.**  
 Coyne Electrical and Radio School  
 500 S. Paulina St., Dept. C-8-SH, Chicago 12, Ill.

Please send Big FREE Book and complete details.

NAME . . . . .  
 STREET . . . . .  
 CITY . . . . . STATE . . . . .

McMurdo  
**SILVER ADDS**  
**REVOLUTIONARY**  
**NEW SELECTIVITY**

We use "revolutionary" advisedly. You'll agree when you add new "805" 100 kc. I.F. Amplifier to your present receiver that the phone/broadcast selectivity and noise reduction it gives are revolutionary. Less than this improvement has been described as "like nothing you've ever seen or heard before".

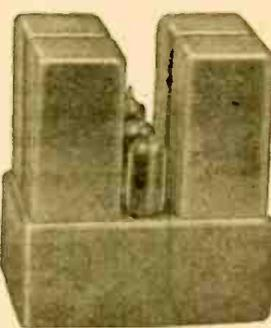

Added to any superhet having i.f. lying between 450 and 500 kc., Model 805 will cut dial-spread on even the strongest local station down by 75% . . . will reduce noise unbelievably. It gives your present set a selectivity curve of 2.4 kc. wide 2X down, falling almost vertically to only 7.2

kc. wide at 10,000X down—an engineering dream come true. 805 gives single-side-band selectivity, the ability to reject noises, heterodyne squeals and all QRM on one side of the signal or the other—yet get clear, crisp speech and music without deleterious side-band cutting.

Add Model 805 to your present set, and you have next year's new receiver today. Its selectivity gain-noise reduction is revolutionary.

Price, less 1 ea. 6BE6, 6BA6, 6C4 tubes \$18.90  
 Model 805K Kit with pictorial instructions \$15.90

OVER 37 YEARS OF RADIO ENGINEERING ACHIEVEMENT  
**McMurdo Silver Co., Inc.**  
 EXECUTIVE OFFICES 1240 MAIN ST. HARTFORD 3, CONN.  
 FACTORY OFFICE 1249 MAIN ST. HARTFORD 3, CONN.

TUBES		TUBES	
1LH4 . . . . .	\$.59	6X5GT/G . . . . .	\$.45
1LN5 . . . . .	.59	5RYGY . . . . .	.89
3B7 . . . . .	.89	5U4G . . . . .	.45
306 . . . . .	.69	12A6 . . . . .	.30
3Q4 . . . . .	.59	12SA7GT . . . . .	.35
3S4 . . . . .	.49	12SK7GT . . . . .	.40
6AC7 . . . . .	.59	12SG7 . . . . .	.62
6AB7 . . . . .	.89	16Z5 . . . . .	.35
6AG7 . . . . .	.79	2050 . . . . .	.69
6HG7 . . . . .	.79	30 . . . . .	.60
6D6 . . . . .	.40	34 . . . . .	.89
6J5 . . . . .	.39	803 . . . . .	6.00
6SK7 . . . . .	.40	807 . . . . .	.95
6SL7 . . . . .	.40	LOWEST PRICES	
6SN7 . . . . .	.40	NEW — STANDARDS	
6SJ7 . . . . .	.39	6V6GT/G . . . . . .45	
6V6GT/G . . . . .	.45	BRANDS	
Di Heptol Sockets (less mounting ring) .50 ea.			
2 x 2 Sockets . . . . . .35 ea.			
Octol Stentite Socket . . . . . .15 ea.			

**G. E. Switchettes**  
 # CR-1070C103-B3 normally open . . . . .35 ea.  
 # CR-1070C123-C3 normally open . . . . .35 ea.  
 # CR-1070C103-K2 normally closed. . . . .35 ea.

**Dynamic Microphone Electro-Voice**  
 Model 600 C (press to talk switch)  
 High Impedance . . . . .4.50 ea.  
 Steppedown Xformer UTC Type 63833  
 220V to 110V—100 Watts—60 cycles. .4.00 ea.

**Specials:**  
 Small 110V 60 cycles AC open frame motor 1/2" shaft, 2700 RPM, 1/70 H.P. mfg. by Barber Colman Co. . . . .2.00 ea.

**Synchronous Motor**  
 1/2" shaft 110V—AC—60 cycle, 4/5, 1, 1 1/5 x 1 1/4 R.P.M. 2.2 Watts. Mfg. by Hayden Mfg. Co. . . . .2.00 ea.  
 Specify speed desired.

**Standard Brands**  
 Capacitor—500 Mfd. 200V DC . . . . .1.75 ea.  
 Oil Filled Condensers:  
 4 Mfd. 2000V DC . . . . .3.75  
 10 Mfd. 1500V DC . . . . .2.95  
 10 Mfd. 600V DC . . . . .90

No sale less than \$2.00. All prices FOB N.Y.C. Add 25c to cover postage. 20% deposit required with all orders.

**A. M. RADIO SALES CO.**  
 345 Canal St. N. Y. C. 13, N.Y.

# RADIO SCHOOL DIRECTORY

## PRACTICAL TECHNICAL TRAINING

*Specialize*

### IN RADIO, ELECTRONICS ELECTRICAL ENGINEERING

Prepare for a successful career in industry or a business of your own in 6 months to 3 years. More than 35,000 former students in industry the world over. 1,538 students now enrolled from 48 states and 13 overseas countries. Faculty of 72 specialists. Write for Catalog and Personal Guidance Questionnaire.



B.S. Degree in Electrical Engineering with Major in Electronics in 3 Years.

Terms start September, January, April, July.

**MILWAUKEE**  
**SCHOOL OF ENGINEERING**  
A Technical Institute Founded 1903

Dept. RC-848 North Broadway, Milwaukee, Wisconsin

#### COURSES

- SERVICE  
6 to 12 Months
  - Electricity
  - Welding
  - Refrigeration
  - Heating
- TECHNICIAN  
1 to 2 Years
  - Electricity
  - Radio
  - Electronics
  - Refrigeration, Heating and Air Conditioning
- PROFESSIONAL  
3 Years
  - Electrical Engineering
  - Bachelor of Science Degree
  - Major In Machinery or Electronics

### FM-RADIO-TV PRACTICAL TRAINING

Four fully-equipped laboratories provide the PRACTICAL training essential for successful careers in Radio Communications (FCC licenses) and in Radio-Television Servicing (Technician). Train under the supervision of technical specialists — with commercial-type equipment. Investigate why WRCI SPECIALIZED TRAINING methods are outstanding; why WRCI laboratory-trained specialists are in demand. Read our illustrated bulletin before enrolling in any school. Approved for veteran training—non-veterans accepted. Send for free copy of Bulletin-J today.

Western Radio Communications Institute  
Specialists in Radio-Electronics Training  
341 West 18th Street, Los Angeles 15, Calif.

### TELEVISION 1948!!

Train at an Institute that pioneered in TELEVISION TRAINING since 1938. Morning, Afternoon or Evening Sessions in laboratory and theoretical instruction, under guidance of experts, covering all phases of Radio, Frequency Modulation, Television, lead to opportunities in Industry, Broadcasting or own Business. Licensed by N. Y. State. Approved for Veterans.

### RADIO-TELEVISION INSTITUTE

480 Lexington Ave., N. Y. 17 (46th St.)  
Plaza 3-4585 2 blocks from Grand Central

### RADIO ENGINEERING I

Complete Radio Engineering Course. Bachelor of Science Degree. Courses also in Civil, Electrical, Mechanical, Chemical, Aeronautical Engineering; Business Administration, Accounting, Secretarial Science. Graduates successful. 65th year. Enter Sept., Jan., March, June. Write for catalog.

TRI-STATE COLLEGE 2488 College Ave. ANGOLA INDIANA

**THIS COUPON MAY PROVE TO BE THE KEY TO YOUR SUCCESS IN ELECTRONICS**

### MELVILLE RADIO INSTITUTE

The Progressive Radio School  
Managed by Radio Men  
Licensed by the N. Y. State Board of Education  
RECOGNIZED BY INDUSTRY  
APPROVED FOR VETERANS

CUT IT OUT! FILL IT OUT! MAIL IT OUT! — NOW!

MELVILLE RADIO INSTITUTE RC  
Melville Bldg., 13 W. 46th St., N. Y. 19, N. Y.

Send me without obligation information about your intensive courses:

- Radio Technician
- Radio & Television Servicing
- Radio Communications
- Fundamental Radio Mathematics

My Name.....

Address.....

### RADIO COURSES

Preparatory, Service, Broadcast, Television, Marine Operating, Aeronautical, Frequency Modulation, Radar.

Classes forming for fall term Oct. 1.  
Entrance exam Sept. 20.  
Veterans. Literature.

### COMMERCIAL RADIO INSTITUTE

(Founded 1920)  
38 West Biddle Street, Baltimore 1, Md.

### RADIO

TECHNICIAN and RADIO SERVICE COURSES  
FM and TELEVISION

### AMERICAN RADIO INSTITUTE

101 West 63rd St., New York 23, New York  
Approved Under GI Bill of Rights  
Licensed by New York State

### RADIO COURSES

- RADIO OPERATING
- RADIO SERVICING
- F.M. TELEVISION
- CODE
- ELECTRONICS

### REFRIGERATION SERVICING

Write for Catalog and Picture Brochure  
Y.M.C.A. TRADE & TECHNICAL SCHOOLS  
15 W. 63rd St. (N'r B'way) New York City

## WANTED:

Men and Women to Fill  
**TOP RADIO JOBS**  
in AM—FM—Television

If you are looking for a career with a future, why not join the hundreds of graduates from the Don Martin School of Radio arts now successfully employed in the radio industry. The demand is great for qualified radio personnel in AM-FM-Television. Train now to be an announcer, script writer, disk jockey, newscaster, or radio engineer. Complete day and night classes with the latest equipment. Free Placement service. Approved for veterans. Write for free booklet.

### Don Martin School of Radio Arts

1655 North Cherokee St. Hollywood 28, Calif.

## A CAREER WITH A FUTURE! TELEVISION

- SHOP WORK • SHOP TECHNIQUES • THEORY • FULLY EQUIPPED LABORATORIES
- RADIO SERVICE & REPAIR
- F. M. & TELEVISION
- TRANSMITTER COURSES

Preparing for F. C. C. LICENSES  
• RADIO TECHNOLOGY  
MORNING • AFTERNOON • EVENING CLASSES • MODERATE RATES • INSTALLMENTS  
AVAILABLE UNDER G. I. BILL

### DELEHANTY SCHOOL OF RADIO • ELECTRONICS • TELEVISION.

105 EAST 13th STREET, NEW YORK 3, N. Y. • DEPT. R  
LICENSED BY STATE OF NEW YORK

## LEARN RADIO!

IN ONLY 10 MONTHS  
PREPARE FOR A GOOD JOB!  
COMMERCIAL OPERATOR (CODE)  
BROADCAST ENGINEER  
RADIO SERVICEMAN

Television Servicing—15 Months

Veterans get \$130.00 Equipment  
SEND FOR FREE LITERATURE  
BALTIMORE TECHNICAL INSTITUTE  
1425 Eutaw Place, Dept. C, Baltimore 17, Md.

## RADIO ENGINEERING

### FM—Television—Broadcast

Police Radio, Marine Radio, Radio Servicing, Aviation Radio and Ultra High mobile applications. Thorough training in all branches of Radio and Electronics. Modern laboratories and equipment. Old established school. Ample housing facilities. 7 acre campus. Small classes, enrollments limited. Our graduates are in demand. Write for catalog.

Approved for Veterans  
VALPARAISO TECHNICAL INSTITUTE  
Dept. C VALPARAISO, INDIANA

## RCA INSTITUTES, Inc.

Offer thorough training courses in all technical phases of  
**Radio and Television**

DAYS—EVENINGS WEEKLY WATER  
VETERANS: RCA Institutes is approved under G. I. Bill of Rights

For Free Catalog Write Dept. RC-48  
**RCA INSTITUTES, Inc.**  
A Service of Radio Corporation of America  
350 WEST 4TH STREET NEW YORK 14, N. Y.

## SOUND RECORDING SCHOOL

A practical engineering course in Sound Fundamentals, Recording, and Sound Transmission measurements; in a laboratory containing transmission sets, oscillators, square wave generator and intermodulation analyzer, and other equipment.  
Complete recording studio assimilating broadcast, motion picture and commercial sound recording, under the direction of H. M. Tremaine.

HOLLYWOOD SOUND INSTITUTE, Inc.  
1040-C No. Kenmore Hollywood 27, Calif.



Twenty-four chapters cover practically all types of electronic circuits and tubes used in communications and electronic control. Among the subjects covered are: Basic a.c. theory, circuit constants, filters, amplifiers, transients, receivers, transmitters, vacuum tubes, cathode-ray tubes, timing and keying circuits.

Oscillators and wide-band amplifiers are covered more fully than in many texts of this type. The well-known but seldom-discussed effects of tightly-coupled tuned circuits on oscillator stability and calibration are described and discussed in Chapter XV. Design data on compensated wide-band amplifiers is complete with practical examples of actual circuits.

Four appendices: Review of Mathematics, Brief Review of Electricity and Magnetism, Description of a Direct-Current Source in Terms of Electrical Constants, and Symbols and Abbreviations are included.—R.F.S.

**ELEMENTARY MANUAL OF RADIO PROPAGATION**, by Donald H. Menzel. Published by Prentice-Hall, Inc. Loose-leaf flat-ring binding with flexible leatherette covers. 8 1/2 x 11 1/2 inches, 222 pages. Price \$7.65.

A complete work describing the methods of calculating propagation paths between radio stations and the theory behind such calculations. Absorption and lowest usable high frequencies are considered as well as the more commonly considered maximum usable frequencies. The book as a whole serves as an advanced text to the person with experience in making calculations from the CRPL charts, as well as a complete manual to the newcomer in the art.

A number of chapters are devoted to calculating the coverage of a given transmitting station. A number of other interesting points, including variability of the sun, problems of broadcast and lower frequencies, and propagation effects deduced from weather conditions, are covered in separate chapters. Two appendices discuss the theory of ionospheric and tropospheric propagation.

**ESSENTIALS OF RADIO**, by Morris Slurberg and William Osterheld. Cloth covers; 806 pages; illustrated. Size 6 1/2 by 9 inches. Published by McGraw-Hill Book Co. Price \$5.00.

This book, written for the radioman with a knowledge of simple high-school algebra, is an excellent treatise which covers all branches of the radio transmitting and receiving art, including FM and AM.

One of the opening sections deals with circuit analysis, including the calculation of inductance of coils and the capacity of condensers. The power transformer is described at length. The calculation of circuit constants is carefully explained for both a.c. and d.c. systems, with the necessary simple mathematics. Receiving circuits and vacuum tubes are

covered completely. A series of questions and problems and a bibliography appended at the end of each chapter are useful to the student.

This reviewer would like to have seen more space devoted to antennas and transmission lines, especially the effect of standing waves on FM and TV.

The tables include logarithms, sines and cosines, copper wire sizes, letter symbols used in electronics, conversion factors, freq.-wavelength and LC products, receiving tube data and socket diagrams, resistance-capacity-coupled amplifier chart, and other useful information.—H.W.S.

**TELEVISION TODAY**, by Roy C. Norris. Published by Rockliff (Great Britain). 5 1/4 x 8 3/4 inches, 249 pages plus index. Price 21 shillings.

Written for the reader with a moderate knowledge of a.c. and d.c. theory, this book gives a "from the ground up" description of how a television system operates.

An English publication, it devotes some space to an interesting comparison of British and American television systems, and presents complete information on all the important details of transmission.

Receivers are covered thoroughly, as well as antennas and antenna theory, large-screen television, color and stereoscopy, and system adjustment and trouble-shooting.

The many diagrams are clearly drawn and are placed so that each drawing is on the same page as the explanatory text.—R.H.D.

**FINAL ACTS OF THE INTERNATIONAL TELECOMMUNICATION AND RADIO CONFERENCES**. Published by the International Telecommunications Union, distributed by the American Radio Relay League. 5 1/4 x 8 1/2 inches, 426 double pages. Price \$1.50.

This book contains the new International Telecommunications Convention, the International Radio Regulations, and all the Appendices, Annexes, Protocols, Resolutions, and Recommendations arrived at during the Atlantic City Conference last year. Representing the work of 79 nations, these documents are detailed and explicit. They provide source material on which international radio regulation will be based for some years to come.

Two official texts of the Convention are given on opposing pages throughout the book, French on one page and English on the facing one.

## A Complete, Practical Handbook of Present-day TELEVISION

Now, the tremendous opportunities in the field of television are brought within your reach—by means of this crystal-clear book. Written in plain English, concise and up to the minute, it makes television easy to understand. There is no mathematics to confuse you and make explanations difficult to follow. Hundreds of vivid illustrations bring every fact and point right before your eyes. You'll be amazed at how simple television can become with

New Second Edition—453 Pages



# TELEVISION SIMPLIFIED

by MILTON S. KIVER

Associate Instructor in radio, U.S. Army Air Forces. Formerly Instructor in radio, Illinois Institute of Technology.

This brand-new, authoritative handbook not only contains all the information you need for success in television, but covers the trouble shooting and repair of radio sets. Beginning with a clear, overall picture of the entire field, it breaks down the television receiver into its component parts and circuits. It analyzes them, step by step, showing how they are formed, the roles they play, and their operating characteristics.

### BRIEF OUTLINE OF CONTENTS

The Television Field; Ultra-high Frequency Waves and the Television Antenna; Wide-band Tuning Circuits, Radio-frequency Amplifiers; The High-frequency Oscillator, Mixer and Intermediate-frequency Amplifiers; Diode Detectors and Automatic gain-control Circuits; Video Amplifiers; Direct-current Reinsertion; Cathode-ray Tubes; Synchronizing Circuit Fundamentals; Deflecting Systems; Typical Television Receiver—Analysis and Alignment; Color Television; Frequency Modulation; Servicing Television Receivers; Glossary of Television Terms.

### EXAMINE THIS BOOK FREE

Let this great book prepare you to take advantage of the brilliant opportunities television offers. Send for it NOW!!

-----MAIL THIS COUPON-----

D. VAN NOSTRAND COMPANY, INC.  
250 Fourth Avenue, New York 3, New York

Please send me "Television Simplified." Within 10 days I will either return the book or send you \$2.00 after examination and \$2.00 a month for two months (\$6.00 in all) plus a few cents postage. Return postage is guaranteed.

Name .....

Address .....

City ..... State .....

Radio Craft Aug. 48

Hollywood Experts Help You **Make Good in RADIO-TELEVISION** at Home

Direct from Hollywood, nerve-center of broadcasting, Television, Radio and Sound activities, comes R.T.A.'s time-proven and tested home training. Here a last-easy-to-learn, home instruction that quickly qualifies you for steady, good-pay jobs or your own Radio business. 10 big kits of radio parts given at no extra charge. Get full details at once! Send postal for FREE BOOK "How to Make Good in Radio-Television!"

RADIO TRAINING ASS'N OF AMERICA, Dept. RCG  
5620 Hollywood Blvd. Hollywood 28, Calif.

**CODE SENDING SPEED**  
**RECEIVING SPEED**

Be a "key" man. Learn how to send and receive messages in code by telegraph and radio. Commerce needs thousands of men for jobs. Good pay, adventure, interesting work. Learn at home quickly through famous Candler System. Quality for Amateur or Commercial License. Write for FREE BOOK.

CANDLER SYSTEM CO.  
Dept. 3-J, Box 928, Denver 1, Colo., U.S.A.

**CORRESPONDENCE COURSES IN RADIO and ELECTRICAL ENGINEERING**

**ELECTRICAL ENGINEERING** Get good grasp of wide electrical field. Prepare yourself at Low Cost. for secure future. Modern course. So simplified anyone can understand quickly.

**RADIO ENGINEERING** Extra fine course in radio, work. Trains you to be super-service man, real vacuum-tube technician. Servicemen needed badly. Diploma on completion. Many graduates earning big pay.

Send postcard for Free Copies of school catalog, full details, all \$25 Either about deferred payment plan, experimental kits, etc. Course Lincoln Engineering School, Box 931-C-114, Lincoln 2, Nebr.

# EVERYTHING IN TELEVISION

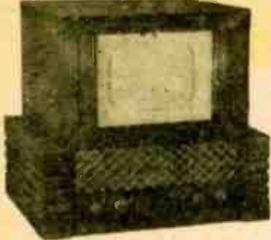

MODEL EL-1

Latest design • Features High Definition, Brilliance and Stability • New Synchro-Lock and Contrast Emphasis Circuits • 55 sq. in. Screen • Beautiful Cabinets

RECEIVERS, FM STRIPS, TEST EQUIPMENT, KITS, FILTERS, LENSES, DECALS, TUNERS, ACCESSORIES, COMPONENTS, ASSEMBLIES, ANTENNAS, CABINETS



## SURPLUS RADIO, INC.

44-31 Douglaston Pkwy  
Douglaston, L. I., N. Y.

Please send me your FREE Catalog

Name \_\_\_\_\_  
Address \_\_\_\_\_  
Town \_\_\_\_\_ State \_\_\_\_\_

## LEOTONE SUMMER SPECIALS

12" CINAUDAGRAPH PM SPEAKERS (NY-1212). This famous heavy duty speaker boasts an oversized 60 oz. Alnico Magnet. Factory rebuilt, like new. 8 ohm voice coil. FINEST REPRODUCTION for Radio. Phono of Public Address work. Handles 15 watts. GUARANTEED FOR A FULL YEAR. Less transformer. Shpg. wt. 10 lbs. . . . . 9.95

RM-4 RECORDING MOTOR. Heavy duty 110V. 60 cycle shaded pole induction type. Silent operating for WIRE, TAPE or DISC RECORDING, fans, heaters, etc. 5/16" O.D. shaft. 3 3/4" sq. x 2 3/4". Less turntable, mtg. plate & reduction drive wheel. Shpg. wt. 6 lbs. . . . . **4.95**

WRITE TODAY FOR OUR LATEST "WIRE & TAPE RECORDING PARTS" SUPPLEMENT

TELEVISION FOCUS COIL. For use with 10", 12" or 15" tubes. 275 ohms DC @ 125MA. Fully shielded. Triangular 1/4" mtg. 1-9/16" hole. Shpg. wt. 4 lbs. A Real Value at 4.25

T-30 THROAT MIKES. 2 rubber-set carbon buttons exclude outside noise, leaves hands free. Complete with neckband, PL-251 plug & rubber cord. BRAND NEW . . . . .39, 12 for 2.98

ANTENNA LOOPS. High Gain. spider wound for max. pick-up. 3" round or 4" x 8" oval. Either. . . . . 29

"BOUNCER" OUTPUT TRANSFORMER (7/8" x 1-3/16"). 2000 ohm tapped double primary to voice coil. Excellent for use with Beam Power type tubes . . . . .49, 12 for 5.00

110V. AC RELAY (W-L). SPST. hvy duty 20A. Silver contacts. 700 ohm coil. Mtd. on 3/8" bakelite base. Overall: 3 3/4" x 1 3/4" x 1 3/4". Now only 1.49

### SPEAKER ACCESSORIES KITS

SPEAKER CONES—Kit of 12 asstd. 4" to 12" moulded & free-edge (magnetic incl). Less voice coils. . . . . 2.00  
SPEAKER REPAIR KIT—A real money & time saver. Contains 25 asstd. paper rings, 10 spiders, 25 voice coil forms, 3 yds. felt strips, 20 chamois leather segments, kit of 16 shims, & tube of speaker cement. All for . . . . . 2.49  
SPEAKER CONE RINGS—50 asstd. cardboard mtg. rings in popular sizes, 3" to 12" . . . . . 1.49  
SPEAKER CEMENT & SOLVENT—3 oz. each of all purpose cement & thinner, with brush . . . . . .69

Minimum Order \$2.00. 20% Deposit Required. Please Add Sufficient Postage.

**LEOTONE RADIO COMPANY**  
65 Dey St., N. Y. 7, N. Y.

## INDEX TO ADVERTISERS

A.M. Radio Sales Co. . . . .	85	Opportunity Adlet . . . . .	76
Abell Distributing Co. . . . .	76	John Porter . . . . .	88
Acorn Electronics Corp. . . . .	71	Precision Apparatus Company . . . . .	73
Allied Radio Corporation . . . . .	4	Progressive Electronics Company . . . . .	54
Alvaradio . . . . .	62	Radio City Products Company, Inc. . . . .	77
American Radio Supply Co. . . . .	68	Radcraft Publications, Inc. . . . .	69, 78
American Sales Company . . . . .	84	Radio Dealers Supply Company . . . . .	83
American Surplus Products . . . . .	50, 62	Radio Kits Company . . . . .	63
Amplifier Corporation of America . . . . .	57, 64, 77, 82	Radionic Equipment Company . . . . .	61
Walter Ashe Radio Company . . . . .	81	Radio Publications . . . . .	84
Audel Publishers . . . . .	81	Radio Supply & Engineering Company . . . . .	82
Bell Telephone Labs. . . . .	49	The Rose Company . . . . .	66
Boland & Boyce Publishers, Inc. . . . .	8, 83		
Brooks Radio Distributing Company . . . . .	61		
Buffalo Radio Supply . . . . .	64, 72, 73, 75, 76, 77, 82, 84, 85		

### RADIO SCHOOL DIRECTORY (Pages 86-87)

Burstein-Applebee Company . . . . .	57	American Radio Institute . . . . .	
Capitol Radio Engineering Institute . . . . .	2, 46	Baltimore Technical Institute . . . . .	
Certified Television Laboratories . . . . .	88	Candler System Company . . . . .	
Cleveland Institute of Radio . . . . .	11	Commercial Radio Institute . . . . .	
Communications Equipment Co. . . . .	80	Deleahy Institute . . . . .	
Coyne Electrical School . . . . .	79, 85	Don Martin School of Radio Arts . . . . .	
Custom-Craft Mfg. Company . . . . .	82	Hollywood Sound Institute, Inc. . . . .	
DeForest's Training Institute . . . . .	9	Lincoln Engineering School . . . . .	
The Electric Auto-Life Company . . . . .	63	Melville Radio Institute . . . . .	
Espey Manufacturing Company, Inc. . . . .	81	Milwaukee School of Engineering . . . . .	
Fair Radio Sales . . . . .	73	RCA Institutes . . . . .	
General Cement Manufacturing Co. . . . .	56	Radio, Television Institute . . . . .	
General Electronic Distributing Co. . . . .	53, 72	Radio Training Association of America . . . . .	
General Salvage Company . . . . .	62	Tri-State College . . . . .	
General Test Equipment . . . . .	79	Valparaiso Technical Institute . . . . .	
Green Radio Distributor . . . . .	52	Western Radio Communications Institute . . . . .	
Greylock Electronic Supply Co. . . . .	64	YMCA Trade & Technical Schools . . . . .	
Hallcrafters Radio . . . . .	75		
The Heath Company . . . . .	6, 7		
Hershel Radio Company . . . . .	14, 15, 16		
Hudson Specialties . . . . .	80	Howard W. Sams & Company, Inc. . . . .	47
Instructograph Company . . . . .	72	Senco Radio, Inc. . . . .	79
Kay Distributing Company, Inc. . . . .	57	Shurite Meters . . . . .	57
Kay Electronics Company . . . . .	79	N. Silverstine Co. . . . .	65
Lafayette Radio . . . . .	75	Sprayberry Academy of Radio . . . . .	5
Lear Radio, Inc. . . . .	55	Superior Instruments . . . . .	71
Leotone Radio Corporation . . . . .	88	Supreme Publications . . . . .	45
McGraw-Hill Book Co., Inc. . . . .	66	Surplus Radio, Inc. . . . .	88
McMurdo Silver Company . . . . .	85, Inside Back Cover	Sylvania Electric Products . . . . .	Back Cover
P. R. Mallory & Co., Inc. . . . .	Inside Front Cover	Technical Radio Parts Company . . . . .	57
Metropolitan Electronic & Instrument Co. . . . .	61	Tel-Craft Company . . . . .	77
Mid-America Company . . . . .	70	Tradio, Inc. . . . .	62
J. W. Miller Company . . . . .	71	Transvision, Inc. . . . .	74
Moss Electronic Distributing Company . . . . .	52	D. Van Nostrand Company, Inc. . . . .	87
Murray Hill Books, Inc. . . . .	72	James Vibrapow . . . . .	56
National Plans Company . . . . .	69	X.L. Radio Laboratories . . . . .	81
National Radio Institute . . . . .	1		
National Schools . . . . .	3		
Niagara Radio Supply Company . . . . .	12, 13		
North American Sales Company . . . . .	84		
Offenbach & Reimus Company . . . . .	64		
Ohmite Manufacturing Company . . . . .	59		

## SALESMEN \$240.49 in One Week Unusual? . . . Not At All!

Just Look at One Week's Earnings of These Representatives:

WWS \$290.99, JMH \$229.75, RJR \$262.47, VJM \$276.95, JEA \$240.49, RWF \$231.21. • Direct mail campaign brings hot leads right into your home. Remarkable product does part of 10 men's work; a natural during these labor problem days. Has perfect sales story; and sells year 'round. As modern as radar! Special demonstrator offer. We extend credit, deliver, collect. No capital required; no experience needed. You make big profit on first sale, and full credit on repeat business. Every business, store, factory, etc. are prospects. Write JOHN PORTER, 2433 Indiana Ave., Dept. 426, Chicago 16, Ill.

## TELEVISION RECEIVER—\$1.00

Complete instructions for building your own television receiver. 16 pages—11"x17" of pictures, pictorial diagrams, clarified schematics. 17"x22" complete schematic diagram & chassis layout. Also booklet of alignment instructions, voltage & resistance tables and troubleshooting hints.—All for \$1.00.

**CERTIFIED TELEVISION LABORATORIES**  
Dept. C, 5507-13th Ave., Brooklyn 19, N. Y.



NO NEED FOR  
**CONFUSION**



Correspondence from service technicians and distributors suggests that many may be confused by the question, "What instruments do I really need to service TV and FM receivers?"

**THERE IS NO NEED FOR CONFUSION!** The answers are simple and direct . . . the new service techniques easy to master when pictorially presented. Only one new instrument must be added — some older instruments be replaced with new models for efficient and profitable TV and FM servicing.

**THE ONE NEW INSTRUMENT** needed is Model 911, a wide-range sweep generator for visual alignment. If you get the one the set makers themselves seem to favor you are naturally best equipped. Equally important, 911 comes to you with *new pictorial instructions*. Specially

**MODEL 911  
 TV/FM SWEEP GENERATOR.**

2 thru 226 mc.; electronic sweep adjustable 0 to 10 mc.; high output adjustable 0 to 1/2 volt. Separate 1 mc. and 5 mc. precision crystal marker oscillators to insure correct TV video i.f. curve shape and width; phasing control and 60~ sine-wave 'scope TV sweep voltage; 120~ saw-tooth FM 'scope sweep voltage. All this, yet only \$78.50 net.

designed for efficient TV and FM servicing, the new Silver Model 911 Sweep Generator takes all confusion out of TV and FM alignment.

**REPLACEMENT OF OBSOLETE** instruments with the new "VOMAX", the famous 906 FM-AM Signal Generator, adding new "SPARX" AM, FM, TV Signal Tracer, will really pay off in TV-FM service profits.



**MODEL 900-A "VOMAX".** The new "VOMAX" is the truly universal v.t.v.m. — makes TV, FM and AM measurements accurately — at highest meter resistance. Giant meter, non-breakable glass; 45 ranges; new single probe for a.c., d.c., a.f., r.f., volts, ohms, db. and current measurements. Advancing far beyond its predecessor, the overwhelming choice of experts, "VOMAX" equips you with the world's newest and finest meter for only \$68.50 net.



**MODEL 906 FM-AM SIGNAL GENERATOR.** Similarly the choice of the big engineering laboratories plus thousands of service technicians, 906 stands out as maximum value. 90 kc. thru 210 mc. in 8 ranges, ±1% accuracy; less than 1/2 microvolt, including strays to over 1 volt v.t.v.m.-metered output; multiple shielding; adjustable 0 to 100% amplitude modulation; adjustable 0 to 1,000 kc. FM sweep. Net price only \$116.50.



**MODEL 905-A "SPARX".** Combining signal-tracer and universal test speaker, 905-A is amazingly sensitive yet free of usual tracer hum. Vacuum-tube prod with r.f.-a.f. switching; high-gain high-fidelity amplifier; 6" PM speaker; 18-watt output transformer gives wide choice of impedances. Two essential instruments in one, 905-A is the finest 37 years of prize-winning radio engineering experience can design — value far exceeding \$44.50 net.

OVER 37 YEARS OF RADIO ENGINEERING ACHIEVEMENT

*McMurdo Silver Co., Inc.*

EXECUTIVE OFFICES: 1240 MAIN ST. HARTFORD 3, CONN.  
 FACTORY OFFICE: 1249 MAIN ST. HARTFORD 3, CONN.

Mail postcard for new catalog of LCETI — Laboratory Caliber Electronic Test Instruments . . . quality and prices which amaze even the experts.

**HUNDREDS OF SERVICEMEN CASHED IN ON SYLVANIA'S SPRING PROMOTION**

# NOW... SYLVANIA OFFERS THE RADIO SERVICEMAN ANOTHER PROFIT-BUILDING PLAN FOR THE FALL!



Shown at the left is one of Sylvania's national ads to appear in Life, The Saturday Evening Post, Collier's, Radio Best... during September, October, November and December. This series of ads is designed to sell you and your dependable radio repair service to your prospects.

**HERE'S HOW YOU TIE UP WITH AND CASH IN ON THESE ADS...**

*...in 5 different ways!*



**1. 4 POSTAL CARD MAILINGS—ONE FOR EACH MONTH**  
Sylvania supplies these cards in 3 colors, imprinted with your name and address. You pay only the postage on each card. You send them to your customers and prospects!



**2. 4 WINDOW DISPLAYS—ONE FOR EACH MONTH**  
Sylvania supplies you FREE 4 big, colorful displays. Each one is tied in with the national advertising using the same illustrations and copy. You put them in your window to attract customers!



**3. 4 WINDOW STREAMERS—ONE FOR EACH MONTH**  
Sylvania gives you FREE these four 2-color streamers. They are also tied in with Sylvania's national advertising. You attach these to your window as another means of attracting new customers!



**4. 8 NEWSPAPER AD MATS—TWO SIZES FOR EACH MONTH**  
Sylvania sends you FREE 2 ad mats for each month—one- and two-column by seven inches. Use them in your local or neighborhood papers and classified telephone directory.

**5. RADIO SPOT ANNOUNCEMENTS—SEVERAL FOR EACH MONTH**

Sylvania also provides FREE several radio commercials for each month for the radio serviceman who uses radio advertising. Call or see your local radio station for rates.

**THIS 4-MONTH ADVERTISING PROGRAM PACKED IN ONE HANDY KIT**

Covering the months of September, October, November and December, this hard-hitting sales promotion program is packed in one big kit. You pay only the postage on the government postal cards you mail. Sylvania supplies everything else without charge.

**YOU CAN IDENTIFY YOURSELF WITH THIS DECAL**  
Put this decal on your door, windows and truck. It is reproduced in Sylvania's national ads and identifies you as the radio serviceman described in Sylvania's national advertising.

Learn how you can participate in this Fall advertising program. Write Sylvania Electric Products Inc., Advertising Department, Emporium, Pa., or see your Sylvania Distributor.



# SYLVANIA ELECTRIC

RADIO TUBES: CATHODE RAY TUBES: ELECTRONIC DEVICES: FLUORESCENT LAMPS, FIXTURES, WIRING DEVICES, PHOTOLAMPS: ELECTRIC LIGHT BULBS